



TECHNICAL CATALOGUE **2013**



EL[®]MARK
PROFESSIONAL ELECTRICAL EQUIPMENT



FACTORY



CENTRAL WAREHOUSE



HEAD OFFICE



ELMARK Has been a registered trademark for Europe since the year of 2000 and is part of the international company ELMARK HOLDING SC. Our company is licensed for the manufacture of the full range of professional low-voltage electrical equipment, lighting products and installation products.

The Headquarters of ELMARK HOLDING SC are situated in Varna, Bulgaria. There is our logistics center which coordinates our activities in Europe and worldwide.

As a member-company of our holding, ELMARK INDUSTRIES SC is controlling the production, while ELEKTROMARKET GRUP EOOD - Bulgaria, ELEKTROMARKET IMPORT-EXPORT SRL-Romania, ELEKTROMARKET GRUP DOO – Serbia, ELEKTROMARKET GRUPA DOO – Croatia, ELEKTROMARKET GRUP KFT – Hungary, ELEKTROMARKET GRUP EPE – Greece, manage our trade activities in the respective countries.

Our plant in Europe is situated in Bulgaria on an area of 10 000 sq.m. In its warehouse we keep on hand large quantities of all products, presented in the technical catalogue. Right from here we distribute the goods for Europe and worldwide. There is an adjacent modern warehouse building, covering 5000 sq.m., which enables us to keep large stocks to better meet the demands of our multiple clients. The management and the quality control of the products we produce are guaranteed by the ISO 9001:2000 certificates, complete Test for certificates for CE marking in accordance with Directive 73/23 EEC and ROHS (Restriction of hazardous Substances) certificates which guarantee the absence of any substances hazardous to the people and the environment.

The full three-year warranty period is an additional proof of the quality of the ELMARK products. It is further accompanied by a special international insurance, which guarantees the coverage of damages which may occur as a result from an action or inaction of our products.

ELMARK HOLDING SC is represented by distributing companies in Bosnia and Herzegovina, Montenegro, Portugal, Macedonia, Belgium, The Netherlands, Poland, Slovenia and Jordan.

Our successful trade policy is due to the high quality of the product range and the successful balance of supply and demand of electrical equipment on competitive prices. As a result, ELMARK HOLDING SC has been a trustworthy and desired partner on the European and world market for twelve years.



CERTIFICATES	6
CIRCUIT BREAKERS	14
Miniature circuit breakers C45, C60	16
Miniature circuit breakers (MCB) C40N	17
Miniature circuit breakers (MCB) C60N	19
Miniature circuit breakers (MCB) C100L	21
Miniature circuit breakers (MCB) C100M	22
Miniature circuit breakers (MCB) C60DC series	24
Miniature circuit breakers (MCB) DP1N (1P + N)	26
Auxiliary devices for circuit breakers	27
Switch disconnectors ISS 63...100A series	28
Isolating switches ISS2 125...800A series	29
Manual switching to reserve series EQ 2M from 125 to 800A	30
High capacity circuit breakers (MCCB) DS1 series from 40 to 800A	31
High capacity circuit breakers DS1 to 1600A – electronic type (MCCB)	34
Auxiliary devices for high capacity circuit breakers DS1 type (MCCB)	35
High capacity circuit breakers (MCCB) DW1 series	38
Dual power change-over switch EQ1 series (ATS)	40
INDIRECT PROTECTION DEVICES	42
Residual current devices JEL 2, JEL 1 / JEL 1A	44
Combined circuit breakers with residual current device JEL5 (RCD)	48
Combined circuit breaker with electronic residual current device	49
Surge arresters SPD type	51
CONTACTORS	54
Low voltage contactors LT 1 – D/K	56
Low voltage contactors LT 1 - F	61
Low voltage contactors with direct current coil LP 1-D	62
AC contactor for switching on of capacitors CJ19-43	63
Reverse contactors LT 4-Dxx	64
Auxiliary contact blocks	65
Module contactors K series	67
CAPACITY COEFFICIENT COMPENSATION	68
Complex compensating devices	70
Capacitor batteries and cosφ regulator	71
Controller for automatic regulation of the capacity factor	72
Metal boxes	73



DEVICES FOR CONTROL AND PROTECTION OF EL. MOTORS	74
Thermal relays	76
Thermomagnetic automatic breaker TM 2/TM 3	78
Auxiliary devices for thermomagnetic automatic breaker TM 2/TM 3	80
Starters for direct start	81
“Star/delta” starter	83
Reverse starters	85
ELM 1000 frequency inverters	86
Auxiliary equipment for frequency inverters	88
ELM 2500 soft starter	89



TIMERS, RELAYS AND DISPLAYING DEVICES	90
Programmable timers	92
Digital counters	96
Industrial Relays	98
Current measurement transformers	100
Devices for temperature measurement	102
Displaying measurement devices	103



ELEMENTS FOR AUTOMATION, MONITORING AND CONTROL	106
Limit switches	108
Proximity sensor	114
Capacitive sensors	115
Photoelectrical sensors	116
Float switches	117
Power supplies	117
Rotary switches	118
Buttons and LED indicators	122
Buttons and LED indicators for DIN-rail	126
Devices for telfer control	127
Warning lights and towers	128
Security sensors	130

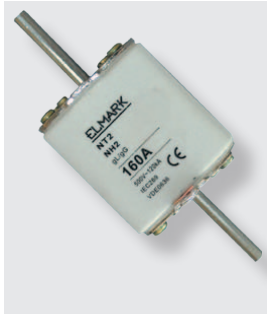

HIGH POWER SAFETY DEVICES AND ISOLATING SWITCHES	132
Bases for high power safety devices	132
Fuse links for high power safety devices	133
Isolating switches	135
Switch disconnecter	136
Bell for DIN rail	137

	ELECTRICAL SWITCHES AND SOCKETS	138
	Rhyme	140
	Splendor	142
	Life style	144
	Cable Trunkings and frames for Splendor and Rhyme Series	146
	Waterproof switches and sockets	150
	Frames and installation boxes for switches and sockets	154
	Waterproof junction boxes	155
	INDUSTRIAL PLUG AND SOCKETS	156
	Industrial plugs	158
	Fixed industrial plugs	159
	Fixed industrial sockets for surface mounting	160
	Movable industrial sockets for surface mounting	161
	Industrial sockets for flush mounting	163
	DISTRIBUTION BOXES	164
	Distribution boxes with industrial sockets	166
	Plastic distribution boxes	167
	Metal distribution boxes	170
	Plastic distribution board	173
	CABLE TERMINALS	174
	Connection tubes	176
	Cable terminals without insulation	178
	Insulated cable terminals	180
	ACCESSORIES	186
	Voltage transformers	188
	German type socket for din rail mounting	190
	Auxiliary devices for circuit breakers	191
	Consumatives	194
	Heat shrinkage tubes	200
	Terminal blocks	202
Cable ties	207	

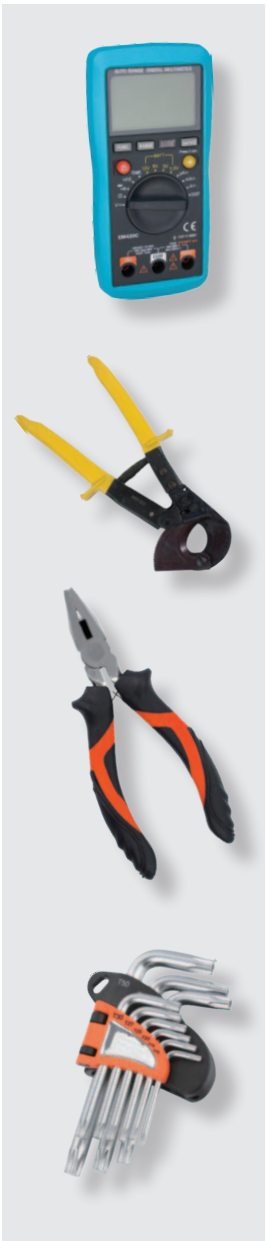

TOOLS	208
Manual meters	210
Crimping tools	216
Mechanical cutting tools	222
Pliers	224
VDE Pliers	228
VDE Screwdrivers	229
Screwdrivers	230
Bit holders	232
Bits	233
Ratchets	238
Socket sets	239
Sockets	240
Wrenches	242
Spanners	243
Hex key sets	246
Bit sets	247
Saws	248
Hammers	249
Snap off knives	250
Measuring tools	251

CERTIFICAT



TIC
TUV International Certification
TUV CERT

Pentru sistemul de management ISO 9001:2008

Aplicarea cerințelor corespunzătoare standardului de referință a fost demonstrată și este atestată, conform procedurilor de certificare, pentru organizația

S.C. ELEKTROMARKET IMPORT-EXPORT S.R.L.
 Șos. București – Urziceni nr. 8
 077010 Afumați, jud. Ilfov
 România

Domeniul de aplicare

Import și comercializare de echipamente electrice.

Numărul de înregistrare al certificatului: TIC 15 100 63643 Valabil până la 2012-04-03
 Raport de audit Nr. 3330 2769 F0 Certificare inițială 2006

Această certificare a fost realizată în conformitate cu procedurile de auditare și certificare ale TIC și se supune auditurilor de supraveghere desfășurate în mod regulat.



TUV Thüringen e.V.
Organismul de certificare pentru sisteme de management și personal



Jena, 2011-05-09



DGA-ZM-03-06-00



Validitatea originalului este aplicabilă în România.

Validitatea originalului este aplicabilă în România.

Validitatea originalului este aplicabilă în România.

Validitatea originalului este aplicabilă în România.



Certificate of Registration

This certificate has been awarded to

ELEKTROMARKET GRUP
10, Perla str., 9009 Varna, Bulgaria

in recognition of the organization's Quality System which complies with

ISO 9001:2008

The scope of activities covered by this certificate is defined below

Import, Export and Wholesale of Electrical Equipment

Certificate Number:	17261
Date of Issue (Original Certificate):	19 April 2006
Date of Issue:	23 April 2010
Expiry Date:	18 April 2012
Issue No:	3

Issued by: 

On behalf of the Schemes Manager



If there is any doubt as to the authenticity of this certificate.

București, str. Grigore Alexandrescu nr. 9
 sector 1, cod 010021
 Tel.: 021-208 59 99; Fax: 021-208 59 98
 40/7425/2000

Cod de înregistrare Fiscaală RO 13267221

Nr. 9900 / 7988 / 



Către,

S.C. ELMARK GRUP S.R.L.
 Afumați, Șos. București-Urziceni, nr. 8
 Tel/Fax.: 021-351.5481/82; Fax: 021-351.5483

Având în vedere politica S.C. ELECTRICA S.A. - București privind stabilirea și consolidarea încrederii în calitatea ofertei de servicii, precum și faptul că organizația d-astră are capacitatea tehnico-profesională conform exigențelor S.C. ELECTRICA S.A. - București, vă informăm că ați fost acceptat ca partener pentru servicii de intermediere pentru:

Produce realizate de: ELMARK INDUSTRIES SC - Bulgaria:

1. Întrerupătoare automate seria MCB (C60N, C100M, DP1N, C60DC, C40N);
2. Întrerupătoare de putere automate seria MCCB (DS1);
3. Întrerupătoare cu protecție la curent diferențial seria RCD (JVL);
4. contactoare seriile LT1-K; LT1-D; LT1-F; LP1-D; CJ19-43; LT4-Dxx; K;
5. Relee termice seriile LT2-K, LT2-E;
6. Întrerupătoare automate termomagnetice seria TM2



Producele oferite vor fi însoțite de:

- copie certificat al sistemului de management al calității la entitatea producătoare, conform standardului ISO 9001:2000;
- autorizația de comercializare emisă de către S.C. ELECTRICA S.A. - București;
- declarația de conformitate conform SR EN 45014:2000;
- documente conform HGR 457/18.04.2003, modificată și completată de HGR nr. 1514/11.12.2003.

Prezentul accept este valabil 24 luni de la data emiterii, în conformitate cu "Instrucțiunea privind acceptarea organizațiilor ofertante pentru livrarea de servicii și/sau produse, precum și emiterea autorizațiilor de comercializare pentru produsele ce pot fi achiziționate de către S.C. ELECTRICA S.A. și filialele/sucursalele sale", cod SCE-01/Ediția 8, Revizia 0, aprobată cu Decizia S.C. ELECTRICA S.A. - București nr. 165/01.04.2005.

Prezentul document nu poate fi utilizat decât în relațiile cu filialele și sucursalele S.C. ELECTRICA S.A. - București, prin participare la atribuirea de contracte pentru achiziții.

DIRECTOR GENERAL,
Corneliu STAN



THE INTERNATIONAL CERTIFICATION NETWORK

CERTIFICATE

IQNet and Quality Austria
 hereby certify that the organization

ELMARK GROUP d.o.o
 Srbija, 34000 Kragujevac, Drage Todorović 4
 Scope of application:
 wholesale of electrical equipment

has implemented and maintains a

Quality Management System

which fulfills the requirements of the following standard

ISO 9001:2000

Issued on:	2007-03-26
Validity date:	2010-03-16
QA certified since:	2007-03-17
Registration Number:	AT-05844/0



René Wasmer
President of IQNet



Viktor Seitschek
President of OQS



IQNet Partners*:
 AENOR Spain AFAQ AFNOR France AIB-Vincotte International Belgium ANCE Mexico APCER Portugal CISQ Italy CQC China
 CQM China CQS Czech Republic Cro Cert Croatia DQS Germany DS Denmark ELIOT Greece FCAV Brazil
 FONDONORMA Venezuela HKQA Hong Kong China ICORTEC Colombia IMC Mexico Inspecta Certification Finland
 IRAM Argentina JQA Japan KFQ Korea MSZT Hungary Nemko AS Norway NSAI Ireland PCBC Poland QMI Canada
 Quality Austria Austria RR Russia SAI Global Australia SH Israel SIQ Slovenia SIRIM QAS International Malaysia
 SGS Switzerland SRAC Romania TEST St Petersburg Russia YUQS Serbia
 IQNet is represented in the USA by: AFAQ AFNOR, AIB-Vincotte International, CISQ, DQS, NSAI Inc., QMI and SAI Global
 *The list of IQNet partners is valid at the time of issue of this certificate. Updated information is available under www.iqnet-certification.com

BUREAU VERITAS
Certification



ELMARK INDUSTRIES AD

2, Dobrudzha Blvd., 9300 Dobrich, Bulgaria

Bureau Veritas Certification certify that the Management System of the above organisation has been audited and found to be in accordance with the requirements of the management system standard detailed below

Standard

ISO 9001:2008

Scope of certification

**Production of Miniature Circuit Breakers (MCB),
Molded Case Circuit Breakers (MCCB), Residual Current Devices (RCD)
and Contactors and Devices for Control and Protection of Electrical Motors.
Assembly of industrial lighting.**

Certification cycle start date: **16 March 2012**

Subject to the continued satisfactory operation of the organization's Management System, this certificate expires on: **16 March 2015**

Original Certification start date: 19 April 2006

Last Expiry Date: 16 March 2012

Date of Last Recertification Audit: 28 February 2012

Certificate No: **BG18406Q**

Issue 1, Revision date: **09 March 2012**

Andrey Yordanov, Technical Manager Bureau Veritas Certification Bulgaria

Accredited office: Great Guildford House, 30 Great Guildford Street, London SE1 0ES, UK

Local site contact details: Telephone: +359 (2) 983 60 44; fax: +359 (2) 983 60 65



008

Further clarifications regarding the scope of this certificate and the applicability of the management system requirements may be obtained by contacting the organization. To check this certificate validity please call: +359 (2) 983 60 44



AOV TEST REPORT AOV TEST REPORT

AOV[®]

Test Report NO.: A0611704L0811 Date: Nov 22, 2006 Page 1 of 8

Customer: ELMARK INDUSTRIES SC
Address: 2 "DOBRIJAZA" BOULEVARD DOBRICH, BULGARIA
Report on the submitted sample said to be

Sample name: Breaker
Model: C21N-C2AN
Item/Lot No.: /
Material: /
Buyer: /
Supplier: /
Manufacturer: /
Sample received date: Nov 08, 2006
Testing period: From Nov 09, 2006 to Nov 22, 2006

Testing Requested
1) As specified by client, to determine the Lead, Cadmium, Mercury, Hexavalent Chromium, PBB & PBDE content in the submitted sample in accordance with Directive 2002/95/EC (RoHS).

Testing method:

Testing Item	Pretreatment method	Measuring Instrument	Report Limit
Lead (Pb)	EPA3050B or Acid Dissolution	ICP-OES	2ppm
Cadmium (Cd)	EN1122: 2001 or Acid Dissolution	ICP-OES	2ppm
Mercury (Hg)	EPA3052	CV-AAS	2ppm
Chromium (Cr VI)	EPA3060A	UV-Vis	2ppm
PBBs	EPA3540C	GC-MS	5ppm
PBDEs	EPA3540C	GC-MS	5ppm

Conclusion:
When tested as specified the submitted sample complied with the requirements of commission Decision of 18/Aug 2005 amending Directive 2002/95/EC notified under document 2005/618/EC
****FOR FURTHER DETAILS, PLEASE REFER TO THE FOLLOWING PAGE(S)****

Signed for AOV Ltd.
Written by *Kenny* Inspected by *Jenabali*
Approved by *Sam*

This Test Report is issued by the Company subject to its Conditions of Issuance of Test Report printed overleaf or attached. The results shown in this Test Report refer only to the sample(s) tested unless otherwise stated and such sample(s) are retained for 30days only. This Test Report shall not be reproduced expected in full, without written approval of the Company.

AOV Testing Technology Co., Ltd.
Address: Flg. 4, Gaoh Technology Industry Zone, Longgang Rd., Nanshan District, Shenzhen, P. R. China
Tel: (86) 755-28733000 Fax: (86) 755-28733439 Http: www.aov.com

NO.: A0708249F2801 Date: Aug 24, 2007 Page 1 of 12

Customer: ELMARK INDUSTRIES SC
Address: 2 "DOBRIJAZA" BOULEVARD DOBRICH, BULGARIA
Report on the submitted sample said to be

Sample name: relay
Model: /
Item/Lot No.: /
Material: /
Buyer: /
Supplier: /
Manufacturer: /
Sample received date: /
Testing period: /

Testing Requested
to determine the Lead, Cadmium, Mercury, Hexavalent Chromium, PBB & PBDE content in the submitted sample in accordance with Directive 2002/95/EC (RoHS).

Testing method:

Testing Item	Pretreatment method	Measuring Instrument	Report Limit
Lead (Pb)	EPA3050B or Acid Dissolution	ICP-OES	2ppm
Cadmium (Cd)	EN1122: 2001 or Acid Dissolution	ICP-OES	2ppm
Mercury (Hg)	EPA3052	CV-AAS	2ppm
Chromium (Cr VI)	EPA3060A	UV-Vis	2ppm
PBBs	EPA3540C	GC-MS	5ppm
PBDEs	EPA3540C	GC-MS	5ppm

Conclusion:
When tested as specified the submitted sample complied with the requirements of commission Decision of 18/Aug 2005 amending Directive 2002/95/EC notified under document 2005/618/EC
****FOR FURTHER DETAILS, PLEASE REFER TO THE FOLLOWING PAGE(S)****

Signed for AOV Ltd.
Written by *Willy* Inspected by *Willy*
Approved by *Willy*

This Test Report is issued by the Company subject to its Conditions of Issuance of Test Report printed overleaf or attached. The results shown in this Test Report refer only to the sample(s) tested unless otherwise stated and such sample(s) are retained for 30days only. This Test Report shall not be reproduced expected in full, without written approval of the Company.

AOV Testing Technology Co., Ltd.
Address: Flg. 4, Gaoh Technology Industry Zone, Longgang Rd., Nanshan District, Shenzhen, P. R. China
Tel: (86) 755-28733000 Fax: (86) 755-28733439 Http: www.aov.com

NO.: ASZ0804020201C Date: Apr 12, 2008 Page 1 of 8

Customer: ELMARK INDUSTRIES SC
Address: 2 "DOBRIJAZA" BOULEVARD DOBRICH, BULGARIA
Report on the submitted sample said to be

Sample name: relay
Model: /
Item/Lot No.: /
Material: /
Buyer: /
Supplier: /
Manufacturer: /
Sample received date: /
Testing period: /

Testing Requested
to determine the Lead, Cadmium, Mercury, Hexavalent Chromium, PBB & PBDE content in the submitted sample in accordance with Directive 2002/95/EC (RoHS).

Testing method:

Testing Item	Pretreatment method	Measuring Instrument	Report Limit
Lead (Pb)	EPA3050B or Acid Dissolution	ICP-OES	2ppm
Cadmium (Cd)	EN1122: 2001 or Acid Dissolution	ICP-OES	2ppm
Mercury (Hg)	EPA3052	CV-AAS	2ppm
Chromium (Cr VI)	EPA3060A	UV-Vis	2ppm
PBBs	EPA3540C	GC-MS	5ppm
PBDEs	EPA3540C	GC-MS	5ppm

Conclusion:
When tested as specified the submitted sample complied with the requirements of commission Decision of 18/Aug 2005 amending Directive 2002/95/EC notified under document 2005/618/EC
****FOR FURTHER DETAILS, PLEASE REFER TO THE FOLLOWING PAGE(S)****

Signed for AOV Ltd.
Written by *Willy* Inspected by *Willy*
Approved by *Willy*

This Test Report is issued by the Company subject to its Conditions of Issuance of Test Report printed overleaf or attached. The results shown in this Test Report refer only to the sample(s) tested unless otherwise stated and such sample(s) are retained for 30days only. This Test Report shall not be reproduced expected in full, without written approval of the Company.

AOV Testing Technology Co., Ltd.
Address: Flg. 4, Gaoh Technology Industry Zone, Longgang Rd., Nanshan District, Shenzhen, P. R. China
Tel: (86) 755-28733000 Fax: (86) 755-28733439 Http: www.aov.com

AOV[®]

Test Report NO.: ASZ0804020501C Date: Apr 12, 2008 Page 1 of 8

Customer: ELMARK INDUSTRIES SC
Address: 2 "DOBRIJAZA" BOULEVARD DOBRICH, BULGARIA
Report on the submitted sample said to be

Sample name: THERMOMAGNETIC AUTOMATIC BREAKER
Model: TM2-E01, 02, 03, 04, 05, 06, 07, 08, 10, 14, 16, 20, 21, 22, 32, TM3-E40, 63, 80
Item/Lot No.: /
Material: /
Buyer: /
Supplier: /
Manufacturer: /
Sample received date: Apr 02, 2008
Testing period: From Apr 02, 2008 to Apr 07, 2008

Testing Requested
As specified by client, to determine the Lead, Cadmium, Mercury, Hexavalent Chromium, PBB & PBDE content in the submitted sample in accordance with Directive 2002/95/EC (RoHS).

Testing method:
With reference to IEC 62321, 111/95/CDV

Testing Item	Pretreatment method	Measuring Instrument	MQL
Lead (Pb)	IEC 62321, section 8/9	ICP-OES	2mg/kg
Cadmium (Cd)	IEC 62321, section 8/9	ICP-OES	2 mg/kg
Mercury (Hg)	IEC 62321, section 7	CV-AAS	2 mg/kg
Chromium (Cr VI)	IEC 62321, Annex B/C	UV-VIS	2 mg/kg
PBBs/PBDEs	IEC 62321, Annex A	GC-MS	5 mg/kg

Note:
* 0.02 mg/kg refers to the MQL of sample extraction liquid.

Conclusion:
When tested as specified the submitted sample complied with the requirements of commission Decision of 18/Aug 2005 amending Directive 2002/95/EC notified under document 2005/618/EC
****FOR FURTHER DETAILS, PLEASE REFER TO THE FOLLOWING PAGE(S)****

Signed for AOV Ltd.
Written by *Cathy* Inspected by *Willy*
Approved by *Jenabali*

This Test Report is issued by the Company subject to its Conditions of Issuance of Test Report printed overleaf or attached. The results shown in this Test Report refer only to the sample(s) tested unless otherwise stated and such sample(s) are retained for 30days only. This Test Report shall not be reproduced expected in full, without written approval of the Company.

AOV Testing Technology Co., Ltd.
Address: Flg. 4, Gaoh Technology Industry Zone, Longgang Rd., Nanshan District, Shenzhen, P. R. China
Tel: (86) 755-28733000 Fax: (86) 755-28733439 Http: www.aov.com

NO.: A07090441A3028 Date: Sep 17, 2007 Page 1 of 8

Customer: ELMARK INDUSTRIES SC
Address: 2 "DOBRIJAZA" BOULEVARD DOBRICH, BULGARIA
Report on the submitted sample said to be

Sample name: Current Device (RCD)
Model: 254053/80A 30/100/300/500mA
Item/Lot No.: /
Material: /
Buyer: /
Supplier: /
Manufacturer: /
Sample received date: /
Testing period: /

Testing Requested
to determine the Lead, Cadmium, Mercury, Hexavalent Chromium, PBB & PBDE content in the submitted sample in accordance with Directive 2002/95/EC (RoHS).

Testing method:

Testing Item	Pretreatment method	Measuring Instrument	Report Limit
Lead (Pb)	IEC 62321, section 11/12/13	ICP-OES	2mg/kg
Cadmium (Cd)	IEC 62321, section 11/12/13	ICP-OES	2 mg/kg
Mercury (Hg)	IEC 62321, section 10	CV-AAS	2 mg/kg
Chromium (Cr VI)	IEC 62321, section 9	UV-VIS	2 mg/kg
PBBs/PBDEs	IEC 62321, section 8.5.1/ 8.5.2	GC-MS	0.02 mg/kg
PBBs/PBDEs	IEC 62321, section 7	GC-MS	5 mg/kg

Note:
* 0.02 mg/kg refers to the MQL of sample extraction liquid.

Conclusion:
When tested as specified the submitted sample complied with the requirements of commission Decision of 18/Aug 2005 amending Directive 2002/95/EC notified under document 2005/618/EC
****FOR FURTHER DETAILS, PLEASE REFER TO THE FOLLOWING PAGE(S)****

Signed for AOV Ltd.
Written by *Willy* Inspected by *Willy*
Approved by *Willy*

This Test Report is issued by the Company subject to its Conditions of Issuance of Test Report printed overleaf or attached. The results shown in this Test Report refer only to the sample(s) tested unless otherwise stated and such sample(s) are retained for 30days only. This Test Report shall not be reproduced expected in full, without written approval of the Company.

AOV Testing Technology Co., Ltd.
Address: Flg. 4, Gaoh Technology Industry Zone, Longgang Rd., Nanshan District, Shenzhen, P. R. China
Tel: (86) 755-28733000 Fax: (86) 755-28733439 Http: www.aov.com

NO.: ASZ0804020501C Date: Apr 12, 2008 Page 1 of 8

Customer: ELMARK INDUSTRIES SC
Address: 2 "DOBRIJAZA" BOULEVARD DOBRICH, BULGARIA
Report on the submitted sample said to be

Sample name: CONTACTOR
Model: 18, 25, 32, 40, 80, 65, 80, 95
Item/Lot No.: /
Material: /
Buyer: /
Supplier: /
Manufacturer: /
Sample received date: /
Testing period: /

Testing Requested
to determine the Lead, Cadmium, Mercury, Hexavalent Chromium, PBB & PBDE content in the submitted sample in accordance with Directive 2002/95/EC (RoHS).

Testing method:

Testing Item	Pretreatment method	Measuring Instrument	MQL
Lead (Pb)	IEC 62321, section 8/9	ICP-OES	2mg/kg
Cadmium (Cd)	IEC 62321, section 8/9	ICP-OES	2 mg/kg
Mercury (Hg)	IEC 62321, section 7	CV-AAS	2 mg/kg
Chromium (Cr VI)	IEC 62321, Annex B/C	UV-VIS	2 mg/kg
PBBs/PBDEs	IEC 62321, Annex A	GC-MS	5 mg/kg

Note:
* 0.02 mg/kg refers to the MQL of sample extraction liquid.

Conclusion:
When tested as specified the submitted sample complied with the requirements of commission Decision of 18/Aug 2005 amending Directive 2002/95/EC notified under document 2005/618/EC
****FOR FURTHER DETAILS, PLEASE REFER TO THE FOLLOWING PAGE(S)****

Signed for AOV Ltd.
Written by *Cathy* Inspected by *Willy*
Approved by *Willy*

This Test Report is issued by the Company subject to its Conditions of Issuance of Test Report printed overleaf or attached. The results shown in this Test Report refer only to the sample(s) tested unless otherwise stated and such sample(s) are retained for 30days only. This Test Report shall not be reproduced expected in full, without written approval of the Company.

AOV Testing Technology Co., Ltd.
Address: Flg. 4, Gaoh Technology Industry Zone, Longgang Rd., Nanshan District, Shenzhen, P. R. China
Tel: (86) 755-28733000 Fax: (86) 755-28733439 Http: www.aov.com

LVD Body

CENTER FOR TESTING AND EUROPEAN CERTIFICATION
23 "Patriarh Evtimii", Stara Zagora, Bulgaria
tel. + 359 42/ 620368; fax + 359 42/ 602 377; ctec@ctec-sz.com
Authorization № 036-OC/31.03.2006 by SAMTS

Expert report
№ LVDb-08-003-003-044

Applicant
"ELMARK HOLDING" S.C. BULGARIA, ZPZ 10" PERLA" str. Bulgaria

Manufacturer
"ELMARK INDUSTRIES" S.C. BULGARIA, 2 "Dobrudja" blvd., Dobrich, Bulgaria

Electrical device
AC contactor
ELMARK LTI- D0910

Grounds
Application form № 001-LVDb-08-003
Technical file expertise
Conformity assessment of electrical device test report № 001-LVDb-08-003-003
Leading auditor's assessment report

Hereby report CTEC Ltd. verifies that AC contactor ELMARK LTI- D0910 is in compliance with the applicable essential requirements of Directive 2006/95/EC (ex 73/23/EEC) Low Voltage Directive (LVD), laid down with Ordinance for essential requirements and conformity assessment of electrical equipment, designed for use within certain voltage limits.

CTEC manager: /dipl. eng. Blagovesta Shineva/

Integrated part of that document is the leading auditor's assessment report.

LVD Body

CENTER FOR TESTING AND EUROPEAN CERTIFICATION
23 "Patriarh Evtimii", Stara Zagora, Bulgaria
tel. + 359 42/ 620368; fax + 359 42/ 602 377; ctec@ctec-sz.com
Authorization № 036-OC/31.03.2006 by SAMTS

Expert report
№ LVDb-08-001-001-042

Applicant
"ELMARK HOLDING" S.C. BULGARIA, ZPZ 10" PERLA" str. Bulgaria

Manufacturer
"ELMARK INDUSTRIES" S.C. BULGARIA, 2 "Dobrudja" blvd., Dobrich, Bulgaria

Electrical device
Thermal overload relay
ELMARK LT2- E1321

Grounds
Application form № LVDb-08-001
Technical file expertise
Conformity assessment of electrical device test report № LVDb-08-001-001
Leading auditor's assessment report

Ltd. verifies that Thermal overload relay ELMARK LT2- E1321 is in compliance with the applicable essential requirements of Directive 2006/95/EC (ex 73/23/EEC) Low Voltage Directive (LVD), laid down with Ordinance for essential requirements and conformity assessment of electrical equipment, designed for use within certain voltage limits.

CTEC manager: /dipl. eng. Blagovesta Shineva/

Integrated part of that document is the leading auditor's assessment report.

LVD Body

CENTER FOR TESTING AND EUROPEAN CERTIFICATION
23 "Patriarh Evtimii", Stara Zagora, Bulgaria
tel. + 359 42/ 620368; fax + 359 42/ 602 377; ctec@ctec-sz.com
Authorization № 036-OC/31.03.2006 by SAMTS

Expert report
№ LVDb-08-002-002-043

Applicant
"ELMARK HOLDING" S.C. BULGARIA, ZPZ 10" PERLA" str. Bulgaria

Manufacturer
"ELMARK INDUSTRIES" S.C. BULGARIA, 2 "Dobrudja" blvd., Dobrich, Bulgaria

Electrical device
Thermomagnetic automatic breaker TM2-E
ELMARK TM2- E22

Grounds
Application form № LVDb-08-002
Technical file expertise
Conformity assessment of electrical device test report № LVDb-08-002-002
Leading auditor's assessment report

CTEC Ltd. verifies that Thermomagnetic automatic breaker ELMARK TM2- E22 is in compliance with the applicable essential requirements of Directive 2006/95/EC (ex 73/23/EEC) Low Voltage Directive (LVD), laid down with Ordinance for essential requirements and conformity assessment of electrical equipment, designed for use within certain voltage limits.

CTEC manager: /dipl. eng. Blagovesta Shineva/

Integrated part of that document is the leading auditor's assessment report.

LVD Body

CENTER FOR TESTING AND EUROPEAN CERTIFICATION
23 "Patriarh Evtimii", Stara Zagora, Bulgaria
tel. + 359 42/ 620368; fax + 359 42/ 602 377; ctec@ctec-sz.com
Authorization № 036-OC/31.03.2006 by SAMTS

Expert report
№ 001- LVDb-07-004-004-004

LVD BODY FROM EUROPEAN COMMISSION

Applicant
"ELMARK HOLDING" S.C. BULGARIA, ZPZ 10" PERLA" str. Bulgaria

Manufacturer
"ELMARK INDUSTRIES" S.C. BULGARIA, 2 "Dobrudja" blvd., Dobrich, Bulgaria

Electrical device
Moulded case circuit breaker (MCCB)
ELMARK DS1

Grounds
Application form № 001-LVDb-07-004
Technical file expertise
Conformity assessment of electrical device test report № 001-LVDb-07-004-004
Leading auditor's assessment report

Hereby report CTEC Ltd. verifies that the Moulded case circuit breaker model DS1 is in compliance with the applicable essential requirements of European Directive 73/23/EEC, Low Voltage Directives (LVD), laid down with Ordinance for essential requirements and conformity assessment of electrical equipment, designed for use within certain voltage limits.

CTEC manager: /dipl. eng. Blagovesta Shineva/

Integrated part of that document is the leading auditor's assessment report.

LVD Body

CENTER FOR TESTING AND EUROPEAN CERTIFICATION
23 "Patriarh Evtimii", Stara Zagora, Bulgaria
tel. + 359 42/ 620368; fax + 359 42/ 602 377; ctec@ctec-sz.com
Authorization № 036-OC/31.03.2006 by SAMTS

Expert report
№ 001- LVDb-07-003-003-003

LVD BODY FROM EUROPEAN COMMISSION

Applicant
"ELMARK HOLDING" S.C. BULGARIA, ZPZ 10" PERLA" str. Bulgaria

Manufacturer
"ELMARK INDUSTRIES" S.C. BULGARIA, 2 "Dobrudja" blvd., Dobrich, Bulgaria

Electrical device
Residual current devices (RCD)
ELMARK JEL1

Grounds
Application form № 001-LVDb-07-003
Technical file expertise
Conformity assessment of electrical device test report № 001-LVDb-07-003-003
Leading auditor's assessment report

report CTEC Ltd. verifies that the Residual current circuit breaker model JEL1 is in compliance with the applicable essential requirements of European Directive 73/23/EEC, Low Voltage Directives (LVD), laid down with Ordinance for essential requirements and conformity assessment of electrical equipment, designed for use within certain voltage limits.

CTEC manager: /dipl. eng. Blagovesta Shineva/

Integrated part of that document is the leading auditor's assessment report.

LVD Body

CENTER FOR TESTING AND EUROPEAN CERTIFICATION
23 "Patriarh Evtimii", Stara Zagora, Bulgaria
tel. + 359 42/ 620368; fax + 359 42/ 602 377; ctec@ctec-sz.com
Authorization № 036-OC/31.03.2006 by SAMTS

Expert report
№ 001- LVDb-07-001-001-001

LVD BODY FROM EUROPEAN COMMISSION

Applicant
"ELMARK HOLDING" S.C. BULGARIA, ZPZ 10" PERLA" str. Bulgaria

Manufacturer
"ELMARK INDUSTRIES" S.C. BULGARIA, 2 "Dobrudja" blvd., Dobrich, Bulgaria

Electrical device
Miniature circuit breaker (MCB)
ELMARK C63N

Grounds
Application form № 001-LVDb-07-001
Technical file expertise
Conformity assessment of electrical device test report № 001-LVDb-07-001-001
Leading auditor's assessment report

report CTEC Ltd. verifies that the Miniature circuit breaker - model C63N is in compliance with the applicable essential requirements of European Directive 73/23/EEC, Low Voltage Directives (LVD), laid down with Ordinance for essential requirements and conformity assessment of electrical equipment, designed for use within certain voltage limits.

CTEC manager: /dipl. eng. Blagovesta Shineva/

Integrated part of that document is the leading auditor's assessment report.

ZAVOD ZA ISPITIVANJE KVALITETE d.o.o. MOSTAR
QUALITY SUPERINTENDING COMPANY, BOSNIA AND HERZEGOVINA

POTVRDA br.: C-01/16-09/EMZ
o sigurnosti elektroinstalacijskih proizvoda

Prilozi: **AUTOMATSKI OSIGURAAČ-SERIJA C45/C60/DPN/ELM S PRIBOROM**

Proizvođač: **ELMARK INDUSTRIES AD, Bugarska**

Tipovi: 1) C60N**A; 1P/2P/3P/4P; 2) C41N**A; C41N**A; 3) DPN**A; 1P+N; 4) ELM 1P**A; ELM 3P**A

Podnositelj zahtjeva: **ELMARK GRUPA d.o.o.**
Gospodarska 3, 10000 Zagreb

Ovlaštena tvrtka: **ZAVOD ZA ISPITIVANJE KVALITETE d.o.o. Mostar**
Stjepana Musića 91, 88000 Mostar

Ovlaštenje broj: 10-050-1078-1/08

Objavljeno na: 1) Napisi i shematski prikazi; 2) Snimci; 3) Tabele

Dodatci: **ZIK d.o.o.Zagreb / SVJEDODŽBA BR.E-3-21091 i izvještje br. 11127/29.06.2009.**

Z a k l j u č a k / Conclusion

Utvrđeno je da je proizvod **S U K L A D A N** sa zahtjevima sljedećih normi i propisa :

- Pravilnik o tehničkim normativima za električne instalacije niskog napona Slikt SFRJ br. 5388 i 5488
- BAS EN 60898-1:2007+A1:2007+A11:2007, EN 60898-1:2003/A1:2004/A11:2005, IDT
- Električni pribor - Prilozi za prekomernu zaštitu za kućne i slične instalacije - Dio 1: Prilozi za djelovanje pri neizmjenljivoj struji (a-c); - Amper sati [11]

Rođ. valjanost: 31.07.2012. god.

ISPITIVANJE KVALITETE d.o.o. MOSTAR
PERINTENDING COMPANY, BOSNIA AND HERZEGOVINA

POTVRDA br.: C-04/16-09/EMZ
o sigurnosti elektroinstalacijskih proizvoda

AUTOMATSKI PREKIDAČ-SERIJA DSI S PRIBOROM

ELMARK INDUSTRIES AD, Bugarska

1) DS 1-****

je proizvod **ELMARK GRUPA d.o.o.**
Gospodarska 3, 10000 Zagreb

ZAVOD ZA ISPITIVANJE KVALITETE d.o.o. Mostar
Stjepana Musića 91, 88000 Mostar
10-050-1078-1/08

Z a k l j u č a k / Conclusion

je proizvod **S U K L A D A N** sa zahtjevima sljedećih normi i propisa :

- tehničkim normativima za električne instalacije niskog napona Slikt SFRJ br. 5388 i 5488
- 2:2007, EN 60947-2:2006, IDT, IEC 60947-2:2006, IDT
- osobna razvodna i upravljačka postrojenja - Dio 2: Prilozi 4

Rođ. valjanost: 31.07.2012. god.

ISPITIVANJE KVALITETE d.o.o. MOSTAR
PERINTENDING COMPANY, BOSNIA AND HERZEGOVINA

POTVRDA br.: C-06/16-09/EMZ
o sigurnosti elektroinstalacijskih proizvoda

ZAŠTITNI STRUJNI PREKIDAČ-SERIJA JELI/JEL2 (RCD)

ELMARK INDUSTRIES AD, Bugarska

1) JEL (12), 2(4)****A**AA

je proizvod **ELMARK GRUPA d.o.o.**
Gospodarska 3, 10000 Zagreb

ZAVOD ZA ISPITIVANJE KVALITETE d.o.o. Mostar
Stjepana Musića 91, 88000 Mostar
10-050-1078-1/08

Z a k l j u č a k / Conclusion

je proizvod **S U K L A D A N** sa zahtjevima sljedećih normi i propisa :

- tehničkim normativima za električne instalacije niskog napona Slikt SFRJ br. 5388 i 5488
- 7-1:2007, EN 60947-1:2004, IDT, IEC 60947-1:2004, IDT
- 7-2:2007, EN 60947-2:2006, IDT, IEC 60947-2:2006, IDT
- 8: nova razvodna i upravljačka postrojenja - Dio 1: Opcia pravila, Dio2: Prilozi 4
- 8-1: 2007, EN 61008-1:2004, IDT
- 8-2-1: 2007/A1:2007, EN 61008-2-1:1994/A11:1998, IDT
- osobna strujna bez upravljanja prekomjerne zaštite za kućanstvo i slične primjene (RCBBS).

Rođ. valjanost: 31.07.2012. god.

ZAVOD ZA ISPITIVANJE KVALITETE d.o.o. MOSTAR
QUALITY SUPERINTENDING COMPANY, BOSNIA AND HERZEGOVINA

POTVRDA br.: C-08/16-09/EMZ
o sigurnosti elektroinstalacijskih proizvoda

Prilozi: **SKLOPNIK S PRIBOROM**

Proizvođač: **ELMARK INDUSTRIES AD, Bugarska**

Tipovi: 1) L1-L1-D****; L1-L1-K****; 2) L1-L1-F****; 3) L1-P-D****; 4) C1-10-A3****; 5) K**

Podnositelj zahtjeva: **ELMARK GRUPA d.o.o.**
Gospodarska 3, 10000 Zagreb

Ovlaštena tvrtka: **ZAVOD ZA ISPITIVANJE KVALITETE d.o.o. Mostar**
Stjepana Musića 91, 88000 Mostar

Ovlaštenje broj: 10-050-1078-1/08

Objavljeno na: 1) Napisi i shematski prikazi; 2) Snimci; 3) Tabele

Dodatci: **ZIK d.o.o.Zagreb / SVJEDODŽBA BR.E-3-21091 i izvještje br. 11129/29.06.2009.**

Z a k l j u č a k / Conclusion

Utvrđeno je da je proizvod **S U K L A D A N** sa zahtjevima sljedećih normi i propisa :

- Pravilnik o tehničkim normativima za električne instalacije niskog napona Slikt SFRJ br. 5388 i 5488
- BAS EN 60947-1:2007, EN 60947-1:2004, IDT, IEC 60947-1:2004, IDT
- BAS EN 60947-2:2007, EN 60947-2:2006, IDT, IEC 60947-2:2006, IDT
- Niskonaponska razvodna i upravljačka postrojenja - Dio 1: Opcia pravila, Dio2: Prilozi 4
- BAS EN 60947-4-1:A2:2007, EN 60947-4-1:2001/A2:2005, IDT, IEC 60947-4-1:2000/A2:2005, IDT
- Dio 4-1: Električno-mehanički kontaktori i motorni upravljači.

Rođ. valjanost: 31.07.2012. god.

ISPITIVANJE KVALITETE d.o.o. MOSTAR
PERINTENDING COMPANY, BOSNIA AND HERZEGOVINA

POTVRDA br.: C-10/16-09/EMZ
o sigurnosti elektroinstalacijskih proizvoda

RAZVODNI ORMAR

ELMARK INDUSTRIES AD, Bugarska

1) PLASTIC 60****;
2) METAL XFX ***/***/**/

je proizvod **ELMARK GRUPA d.o.o.**
Gospodarska 3, 10000 Zagreb

ZAVOD ZA ISPITIVANJE KVALITETE d.o.o. Mostar
Stjepana Musića 91, 88000 Mostar
10-050-1078-1/08

Z a k l j u č a k / Conclusion

je proizvod **S U K L A D A N** sa zahtjevima sljedećih normi i propisa :

- tehničkim normativima za električne instalacije niskog napona Slikt SFRJ br. 5388 i 5488
- 8-1:2007/A1:2007, EN 60439-1:1999/A1:2004, IDT
- 8-2:2007/A1:2007/A2:2007, EN 60439-2:1991/A11:1994/A2:2001, IDT
- sklopni blokovi, Dio 1-Ispitni ispitni sklopni blokovi, Dio 2- Razvodni blokovi;
- zabjevi za blokove dostupne osušećenim osobama - Razvodne ploče - Ammanum 2

Rođ. valjanost: 31.07.2012. god.

ISPITIVANJE KVALITETE d.o.o. MOSTAR
PERINTENDING COMPANY, BOSNIA AND HERZEGOVINA

POTVRDA br.: C-14/16-09/EMZ
o sigurnosti elektroinstalacijskih proizvoda

TERMOMAGNETNA SKLOPKA S PRIBOROM

ELMARK INDUSTRIES AD, Bugarska

1) TMD- F**

je proizvod **ELMARK GRUPA d.o.o.**
Gospodarska 3, 10000 Zagreb

ZAVOD ZA ISPITIVANJE KVALITETE d.o.o. Mostar
Stjepana Musića 91, 88000 Mostar
10-050-1078-1/08

Z a k l j u č a k / Conclusion

je proizvod **S U K L A D A N** sa zahtjevima sljedećih normi i propisa :

- tehničkim normativima za električne instalacije niskog napona Slikt SFRJ br. 5388 i 5488
- 8-1:2007, EN 60947-1:2004, IDT, IEC 60947-1:2004, IDT
- 8-2:2007, EN 60947-2:2006, IDT, IEC 60947-2:2006, IDT
- 8: nova razvodna i upravljačka postrojenja - Dio 1: Opcia pravila, Dio2: Prilozi 4
- 8-1-4: 2007, EN 60947-4-1:2001/A2:2005, IDT, IEC 60947-4-1:2000/A2:2005, IDT
- električno-mehanički kontaktori i motorni upravljači.

Rođ. valjanost: 31.07.2012. god.

**TEHNIČKI INSTITUT ELEKTROTEHNIKA
FAKULTET CENTAR ZA INOVACIJE MAŠINSTVO
ČAČAK ZAVODI MATERIJALI
RAČUNSKI CENTAR INFORMATIKA
MEHATRONIKA**

UVERENJE O SAGLASNOSTI

Broj 805/4

NA OSNOVU IZVRŠENIH PREGLEDA, MERENJA I ISPITIVANJA, ČIJI SU REZULTATI SADRŽANI U IZVEŠTAJU BR. 805/3 OD 13.04.2006. GOD. IZDAJE SE UVERENJE O TOMJE DA SU

kontaktori
LT1-D0910, 9A, 660V, 50Hz
LT1-D1210, 12A, 660V, 50Hz
LT1-D1810, 18A, 660V, 50Hz
LT1-D2510, 25A, 660V, 50Hz
LT1-D3210, 32A, 660V, 50Hz
LT1-D4011, 40A, 660V, 50Hz
LT1-D6511, 65A, 660V, 50Hz
LT1-D9511, 95A, 660V, 50Hz

čiji je uvoznik preduzeće za trgovinu "ELMARK GROUP" D.O.O., Kragujevac, Drage Todorović 4, a koje je proizvela firma ELMARK GROUP INDUSTRIES LLC USA

IZRAĐENI U SAGLASNOSTI SA STANDARDIMA
IEC60947-4-1 (EN60947-4-1)

I ISPUNJAVAJU SVE ZAHTEVE U POGLEDU KVALITETA, KAO I ZAHTEVE PRIMENE ZA OVU VRSTU PROIZVODA.

U ČAČKU,
13.04.2006. god.

DEKAN
Prof. dr. Jeroslav Živanić, dipl.inž.

**TEHNIČKI INSTITUT ELEKTROTEHNIKA
FAKULTET CENTAR ZA INOVACIJE MAŠINSTVO
ČAČAK ZAVODI MATERIJALI
RAČUNSKI CENTAR INFORMATIKA
MEHATRONIKA**

UVERENJE O SAGLASNOSTI

Broj 805/2

NA OSNOVU IZVRŠENIH PREGLEDA, MERENJA I ISPITIVANJA, ČIJI SU REZULTATI SADRŽANI U IZVEŠTAJU BR. 805/1 OD 13.04.2006. GOD. IZDAJE SE UVERENJE O TOMJE DA SU

**odvojivi zaštitni JELI (dvpolni i četvorpolni)
od napona: dvopolni 230V 50Hz, četvorpolni 400V 50Hz
struje: 25A, 40A, 63A
i (odvodne struje): 30mA, 300mA**

preduzeće za trgovinu "ELMARK GROUP" D.O.O., Kragujevac, Drage Todorović 4, a koje je proizvela firma ELMARK GROUP INDUSTRIES LLC USA

IZRAĐENI U SAGLASNOSTI SA STANDARDIMA
C61008-1, IEC60947-1, IEC60947-3

I ISPUNJAVAJU SVE ZAHTEVE U POGLEDU KVALITETA, KAO I ZAHTEVE PRIMENE ZA OVU VRSTU PROIZVODA.

U ČAČKU,
13.04.2006. god.

DEKAN
Prof. dr. Jeroslav Živanić, dipl.inž.

**TEHNIČKI INSTITUT ELEKTROTEHNIKA
FAKULTET CENTAR ZA INOVACIJE MAŠINSTVO
ČAČAK ZAVODI MATERIJALI
RAČUNSKI CENTAR INFORMATIKA
MEHATRONIKA**

UVERENJE O SAGLASNOSTI

Broj 508/2

NA OSNOVU IZVRŠENIH PREGLEDA, MERENJA I ISPITIVANJA, ČIJI SU REZULTATI SADRŽANI U IZVEŠTAJU BR. 508/1 OD 03.05.2007. GOD. IZDAJE SE UVERENJE O TOMJE DA SU

**AZVODNI ORMARI tipa:
25/15, JXF 30/25/15, JXF 40/30/20, JXF 50/40/20, JXF 60/40/20,
75/20, JXF 80/60/25, JXF 100/80/30, JXF 120/80/30,
meštaj neophodne opreme-automatike za unutrašnje električne instancije u zgradi, kancelarija, prodavnica, hotela i dr., koje uvozi preduzeće ELMARK GROUP" D.O.O., Kragujevac, Drage Todorović 4, a koje je proizvela firma ELMARK GROUP INDUSTRIES LLC USA.**

IZRAĐENI U SAGLASNOSTI SA JUS-IEC (EN) STANDARDIMA
I ISPUNJAVAJU SVE ZAHTEVE U POGLEDU KVALITETA, KAO I ZAHTEVE PRIMENE ZA OVU VRSTU PROIZVODA.

U ČAČKU,
03.05.2007. god.

DEKAN
Prof. dr. Jeroslav Živanić, dipl.inž.

**TEHNIČKI INSTITUT ELEKTROTEHNIKA
FAKULTET CENTAR ZA INOVACIJE MAŠINSTVO
ČAČAK ZAVODI MATERIJALI
RAČUNSKI CENTAR INFORMATIKA
MEHATRONIKA**

UVERENJE O SAGLASNOSTI

Broj 485/3

NA OSNOVU IZVRŠENIH PREGLEDA, MERENJA I ISPITIVANJA, ČIJI SU REZULTATI SADRŽANI U IZVEŠTAJU BR. 485/1 OD 17.03.2006. GOD. IZDAJE SE UVERENJE O TOMJE DA SU

automatski osigurači 400V, 50Hz, maksimalne struje prekidanja 6kA, koje uvozi preduzeće za trgovinu "ELMARK GROUP" D.O.O., Kragujevac, Drage Todorović 4, a koje je proizvela firma ELMARK INDUSTRIES FC BULGARIA po licenci ELMARK GROUP INDUSTRIES USA, koji su označeni sa:

C63N (6, 10, 16, 20, 25, 32, 40, 50, 63)A

IZRAĐENI U SAGLASNOSTI SA JUS-IEC STANDARDIMA
I ISPUNJAVAJU SVE ZAHTEVE U POGLEDU KVALITETA, KAO I ZAHTEVE PRIMENE ZA OVU VRSTU PROIZVODA.

U ČAČKU,
28.03.2006. god.

DEKAN
Prof. dr. Jeroslav Živanić, dipl.inž.

**TEHNIČKI INSTITUT ELEKTROTEHNIKA
FAKULTET CENTAR ZA INOVACIJE MAŠINSTVO
ČAČAK ZAVODI MATERIJALI
RAČUNSKI CENTAR INFORMATIKA
MEHATRONIKA**

UVERENJE O SAGLASNOSTI

Broj 485/2

NA OSNOVU IZVRŠENIH PREGLEDA, MERENJA I ISPITIVANJA, ČIJI SU REZULTATI SADRŽANI U IZVEŠTAJU BR. 485/1 OD 17.03.2006. GOD. IZDAJE SE UVERENJE O TOMJE DA SU

osigurači 230/400V, 50Hz, maksimalne struje prekidanja 6kA, koje uvozi preduzeće za trgovinu "ELMARK GROUP" D.O.O., Kragujevac, Drage Todorović 4, a koje je proizvela firma ELMARK INDUSTRIES FC BULGARIA po licenci ELMARK GROUP INDUSTRIES USA, koji su označeni sa:

G1N (2, 4, 6, 10, 16, 20, 25, 32, 40, 50, 63)A

IZRAĐENI U SAGLASNOSTI SA JUS-IEC STANDARDIMA
I ISPUNJAVAJU SVE ZAHTEVE U POGLEDU KVALITETA, KAO I ZAHTEVE PRIMENE ZA OVU VRSTU PROIZVODA.

U ČAČKU,
17.03.2006. god.

DEKAN
Prof. dr. Jeroslav Živanić, dipl.inž.

**TEHNIČKI INSTITUT ELEKTROTEHNIKA
FAKULTET CENTAR ZA INOVACIJE MAŠINSTVO
ČAČAK ZAVODI MATERIJALI
RAČUNSKI CENTAR INFORMATIKA
MEHATRONIKA**

UVERENJE O SAGLASNOSTI

Broj 805/2

NA OSNOVU IZVRŠENIH PREGLEDA, MERENJA I ISPITIVANJA, ČIJI SU REZULTATI SADRŽANI U IZVEŠTAJU BR. 805/1 OD 13.04.2006. GOD. IZDAJE SE UVERENJE O TOMJE DA SU

osigurači DS1 50A-1600A; 690V, 50Hz, maksimalne struje prekidanja preduzeće za trgovinu "ELMARK GROUP" D.O.O., Kragujevac, Drage Todorović 4, a koje je proizvela firma ELMARK INDUSTRIES FC BULGARIA po licenci ELMARK GROUP INDUSTRIES USA, koji su označeni sa:

**25(40, 50, 63, 80, 100, 125)A Icu=25 kA (415V), 10 kA(690 V)
50 (160A) Icu= 35 kA (415V), 15 kA(690 V)
60 (200,250)A Icu= 50 kA (415V), 15 kA(690 V)
80 (400A) Icu= 65 kA (415V), 25 kA(690 V)
80 (500,630)A Icu= 75 kA (415V), 25 kA(690 V)
80 (800A) Icu= 75 kA (415V), 30 kA(690 V)
500 (1250,1600)A Icu= 85 kA (415V), 50 kA(690 V)**

IZRAĐENI U SAGLASNOSTI SA JUS-IEC(EN) STANDARDIMA
I ISPUNJAVAJU SVE ZAHTEVE U POGLEDU KVALITETA, KAO I ZAHTEVE PRIMENE ZA OVU VRSTU PROIZVODA.

U ČAČKU,
13.04.2006. god.

DEKAN
Prof. dr. Jeroslav Živanić, dipl.inž.

СИСТЕМА СЕРТИФИКАЦИИ ГОСТ Р
ФЕДЕРАЛЬНОЕ АГЕНТСТВО ПО ТЕХНИЧЕСКОМУ РЕГУЛИРОВАНИЮ И МЕТРОЛОГИИ



СЕРТИФИКАТ СООТВЕТСТВИЯ

№ **РОСС ВГ. ХП28.В00278**

Срок действия с **22.01.2010**

по **21.01.2013**

№ **0270204**

ОРГАН ПО СЕРТИФИКАЦИИ **РОСС RU.0001.11ХП28**
ОРГАН ПО СЕРТИФИКАЦИИ ПРОДУКЦИИ "ПРОМСЕРТ"
 Адрес: 119421, г.Москва, ул. Новаторов, д. 36/3, офис 42
 Тел.: 8 (495) 721-38-31, e-mail: info@pssert.ru

ПРОДУКЦИЯ

*Электрическое сигнализационное оборудование т.м. Elmark и Proinstall
 в составе (см. приложение) Бланки № 0224077, 0224011
 Серийный выпуск*

код ОК 005 (ОКП):

42 5000

СООТВЕТСТВУЕТ ТРЕБОВАНИЯМ НОРМАТИВНЫХ ДОКУМЕНТОВ

ГОСТ 25395-2001

код ТН ВЭД России:

8530 00 000 0

ИЗГОТОВИТЕЛЬ

"ELMARK INDUSTRIES SC- BULGARIA"
 Адрес: 2 Dobrudzha Blvd 9300 Dobrich, Bulgaria, Болгария

СЕРТИФИКАТ ВЫДАН

"ELMARK INDUSTRIES SC- BULGARIA"
 Адрес: 2 Dobrudzha Blvd 9300 Dobrich, Bulgaria, Болгария

НА ОСНОВАНИИ

Протокол испытаний № 30- 39-01/10 от 21.01.09г. ИЛ ЭТИ ООО "Эксперт", рег. № РОСС RU.0001.21МЛ36

ДОПОЛНИТЕЛЬНАЯ ИНФОРМАЦИЯ

Маркировка продукции знаком соответствия производится по ГОСТ Р 50460-92. Место нанесения соответствия - в сопроводительной документации.

сертификации № 3

М.П.

Руководитель органа

подпись

Е.А. Дмитриева

инициалы, фамилия

Эксперт

подпись

В.Г. Никифоров

инициалы, фамилия

Сертификат имеет юридическую силу на всей территории Российской Федерации

Allianz Bulgaria
Insurance Co. Ltd.

General Insurance

Allianz 

TO WHOM IT MAY CONCERN

CERTIFICATE OF COVER

This is to certify that we, "Allianz Bulgaria" Insurance Co., Ltd., Bulgaria, Sofia, in our capacity as Insurers, have issued an insurance Policy No 13000110390000001 and effected Product Liability insurance as follows:

ASSURED: ELMARK INDUSTRIES AD, BULSTAT No. 124634156, Dobrich, Dobrudzha 2 Boul.

Interest Production of Miniature Circuit Breakers (MCB), Molded Case Circuit Breakers (MCCB), Residual Current Devices (RCD), Contactors and Devices for Control and Protection of Electrical Motors

Limits: 1 000 000 EUR any one occurrence
1 000 000 EUR in aggregate for the insurance period

PERIOD: TWELVE MONTHS with effect from 01-01-2012

Territorial Scope: Worldwide except USA and Canada and the territories under their jurisdiction

Warranties, if any :

In the event that the Assured or anyone acting on his behalf uses the above information as evidence for insurance or evidence of financial responsibility under any applicable law relating to financial responsibility, or otherwise shows or offers it to any other party as evidence of insurance, it must be clearly understood that this confirmation relates only to the dates set out above and that such insurance is subject to General Conditions of "Allianz Bulgaria", attached clauses and terms, conditions, limitations, exclusions and other provisions of the Insurance Policy issued.

Issued on December 28TH 2011

Place of issue: Varna

"ALLIANZ BULGARIA" INS Co., LTD.

ВЕСЕЛИН ЛЮБЕНОВ ДАСКАЛОВ

Allianz Bulgaria
Insurance Co. Ltd. 039

№ 0038821

CIRCUIT

CIRCUIT BREAKERS

EL[®]MARK

BREAKERS



CIRCUIT BREAKERS

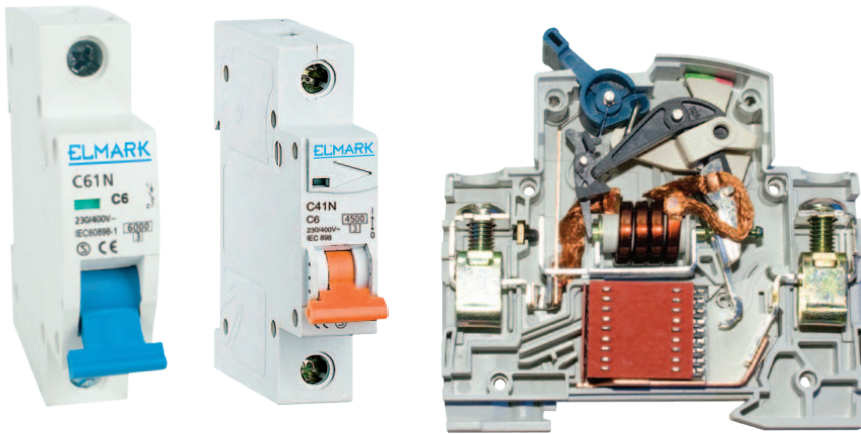

- TERMINAL ①
- NON-FLAMMABLE COVER ②
- JUMP KNUCKLE ③
- HANDLE ④
- LOCK KNUCKLE ⑤
- MOVABLE CONTACT ⑥
- ARC CHAMBER ⑦
- STATIC CONTACT ⑧
- MAXIMUM CURRENT RELEASE ⑨
- AUXILIARY CONTACT (accessory) ⑩
- UNDER VOLTAGE RELEASE (accessory) ⑪
- SHUNT RELEASE (accessory) ⑫

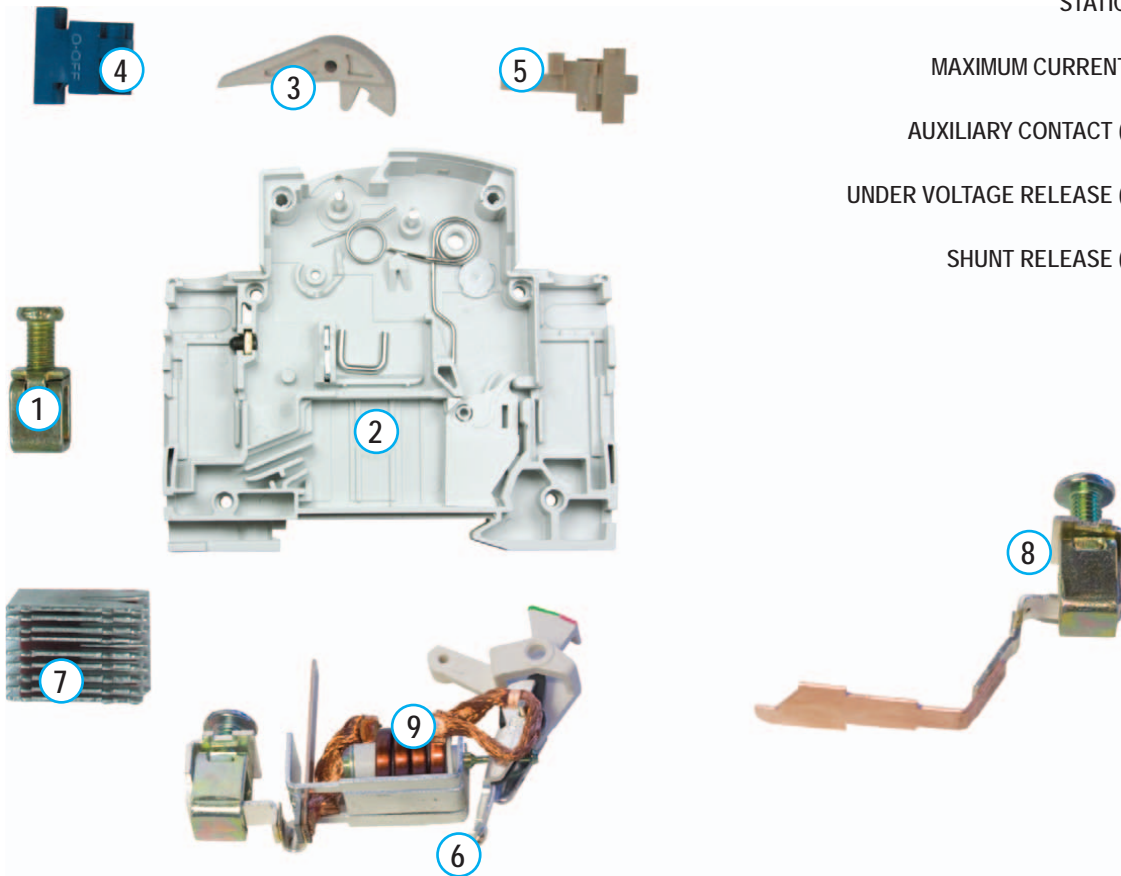

Characteristics

Circuit breakers are automatically-operated electrical switches, designed to protect electrical circuits from damage caused by overload or short circuit. They can also be used as devices for commutation and control of electrical circuits. They differ in the following characteristics:

- * Operating voltage: 230, 400V
- * Number of poles: 1, 2, 3, 4

* Breaking curve:

- curve B – breaks between 3 and 5 In, used for low voltage short circuit currents (long circuits and generators)
- curve C – breaks between 5 and 10 In, used for protection of main power supply cables and conventional consumers
- curve D – breaks between 10 and 20 In, used for protection of industrial consumers with high initial current flow (electric motors)

* Breaking capacity: 4.5, 6, 10kA



C4xN — constructive series
 — number of poles (1;2;3;4)

C x — rated current
 — breaking curve C

Documents corresponding to the product:
 Standard EN60898-1
 EN 60947-2

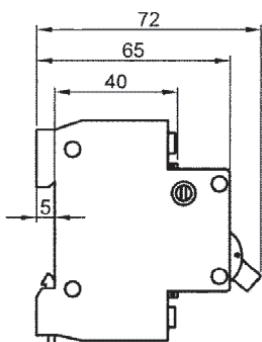
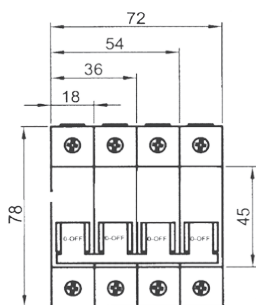
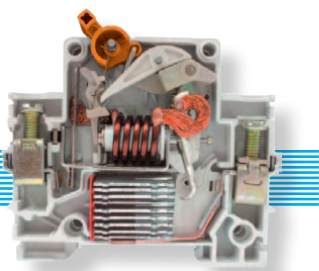

Functions:

- protection of the electrical circuits from overload or short circuits of the outer circuit
- it can be used as a device for commutation and control of electrical circuits
- in combination with auxiliary devices it allows remote control, commutation or indication of the protected circuit
- for mounting in housing and industrial buildings
- for mounting at a distance from the transformer post from 150 to 850 m
- allows protection of consumers generating short circuit currents up to 4500 A

Technical data:

- * Rated voltage: 230/400V; 50/60Hz
- * Breaking capacity (cycle O-CO) in accordance with standard EN 60 898-1: 4500A
- * Rated breaking capacity Ics= 75% Icu
- * Isolating voltage: ≥2000V
- * Electrical wear resistance (number of cycles): 4000
- * Mechanical (number of cycles): 20000
- * Class of current limiting: 3
- * IP code: IP>20
- * Breaking curve:

B curve – the overload and short-circuit protection is activated at 3-5 In. Used for protection of big length cables and power generators.

C – the maximum current release breaks between 5 and 10 In; used to protect main power supply cables and conventional consumers

* Joining terminal: flat (tunnel) screw terminal with composition 1.5 coldly draw-plated plane Q235 – A

* Plastic box – not keeping the burning material nylon PA66, UV rays wear resistance

* Box permittivity strength: >18MV/m

* Abnormal heating wear resistance and fire of the outer parts: 960°C / 3s

* Maximum current release containing:

- copper coil - composition: pure copper T2 type
- resistance: from 0.6 to 180m
- welding effort: <150 000 N/mm
- bimetal plate – composition: 5J158 to TB180 depending on the current
- thickness: 0.6mm (up to 40A) and 0.8mm (up to 63A)
- magnetic core – composition: coldly draw-plated metal wire (1Gr18Ni9)
- thickness: 1.15 to 2.24µm
- drawing effort: from 200 to 400N/mm
- contact head of the movable contact – composition: silver graphite CAg(5)
- dimension 3x3x0.8 (up to 40A) and 4x4x0.8 (up to 63A)
- static contact – composition: pure copper T2Y2
- composition of the contact head: silver graphite CAg(5)

- * Power supply (conducting)
- power supply busbar 1P63, 3P63
- rigid conductors up to 25 mm
- flexible conductors up to 16 mm
- * Tightening moment: 1.33Nm

Mounting:

- * vertical
- * DIN-rail
- * for mounting in housing or industrial environment without serious interference
- * ambient temperature: -5°C to + 40°C±2° C

Type	Rated current In (A)	Breaking capacity (kA)	Recommended sections of the conductors (mm ²)	Packing/Box (pcs)	Catalogue number Curve C	Catalogue number Curve B
C41N / 2A	2	4.5	1.0	12 / 240	41460C	41460B
C41N / 4A	4	4.5	1.0	12 / 240	41461C	41461B
C41N / 6A	6	4.5	1.0	12 / 240	41451C	41451B
C41N / 10A	10	4.5	1.5	12 / 240	41452C	41452B
C41N / 16A	16	4.5	2.5	12 / 240	41453C	41453B
C41N / 20A	20	4.5	2.5	12 / 240	41454C	41454B
C41N / 25A	25	4.5	4.0	12 / 240	41455C	41455B
C41N / 32A	32	4.5	6.0	12 / 240	41456C	41456B
C41N / 40A	40	4.5	10.0	12 / 240	41457C	41457B
C41N / 50A	50	4.5	10.0	12 / 240	41458C	41458B
C41N / 63A	63	4.5	16.0	12 / 240	41459C	41459B

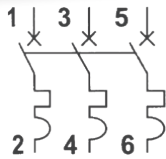

Type	Rated current In (A)	Breaking capacity (kA)	Recommended sections of the conductor (mm ²)	Packing/Box (pcs)	Catalogue number Curve C	Catalogue number Curve B
C42N / 6A	6	4.5	1.0	6 / 120	41470C	41470B
C42N / 10A	10	4.5	1.5	6 / 120	41471C	41471B
C42N / 16A	16	4.5	2.5	6 / 120	41472C	41472B
C42N / 20A	20	4.5	2.5	6 / 120	41473C	41473B
C42N / 25A	25	4.5	4.0	6 / 120	41474C	41474B
C42N / 32A	32	4.5	6.0	6 / 120	41475C	41475B
C42N / 40A	40	4.5	10.0	6 / 120	41476C	41476B
C42N / 50A	50	4.5	10.0	6 / 120	41477C	41477B
C42N / 63A	63	4.5	16.0	6 / 120	41478C	41478B

Type	Rated current In (A)	Breaking capacity (kA)	Recommended sections of the conductor (mm ²)	Packing/Box (pcs)	Catalogue number Curve C	Catalogue number Curve B
C43N / 6A	6	4.5	1.0	4 / 80	41541C	41541B
C43N / 10A	10	4.5	1.5	4 / 80	41542C	41542B
C43N / 16A	16	4.5	2.5	4 / 80	41543C	41543B
C43N / 20A	20	4.5	2.5	4 / 80	41544C	41544B
C43N / 25A	25	4.5	4.0	4 / 80	41545C	41545B
C43N / 32A	32	4.5	6.0	4 / 80	41546C	41546B
C43N / 40A	40	4.5	10.0	4 / 80	41547C	41547B
C43N / 50A	50	4.5	10.0	4 / 80	41548C	41548B
C43N / 63A	63	4.5	16.0	4 / 80	41549C	41549B

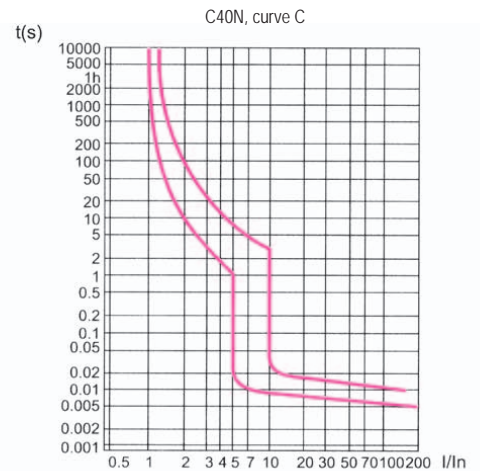
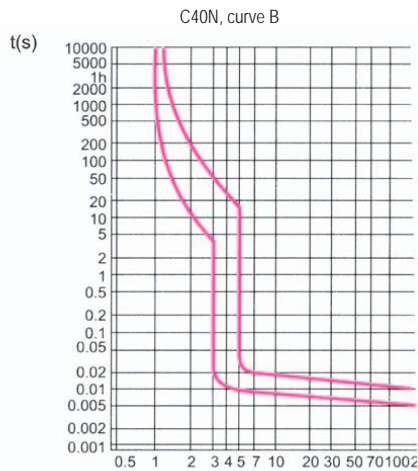

C6xN — constructive series
 — number of poles (1;2;3;4)

C x — rated current
 — breaking curve C

Documents corresponding to the product:
 Standard EN60898-1

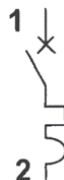
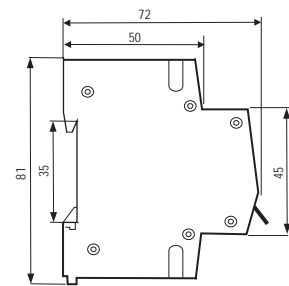
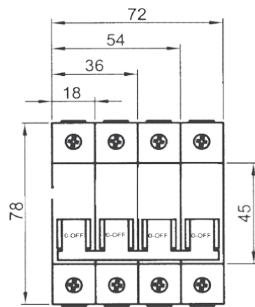
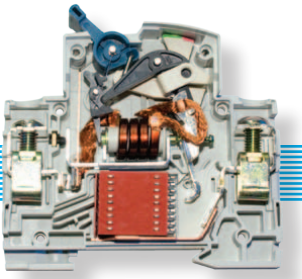

Functions:

- protection of the electrical circuits from overload or short circuits of the outer circuit
- it can be used as a device for commutation and control of electrical circuits
- in combination with auxiliary devices it allows remote control, commutation or indication of the protected circuit
- for mounting in industrial buildings with high contamination level of the electric system
- for mounting at a distance from the transformer post from 150 to 850 m
- allows protection of consumers generating short circuit currents up to 6000 A

Technical data:

- * Rated voltage: 230/400V; 50/60Hz
- * Breaking capacity (cycle O-CO) in accordance with standard EN 60 898-1: 6000A
- * Rated breaking capacity Ics= 75% Icu
- * Isolating voltage: ≥2000V
- * Electrical wear resistance (number of cycles): 8000
- * Mechanical (number of cycles): 50000
- * Class of current limiting: 3
- * IP code: IP>20
- * Breaking curve:

B – the maximum current release breaks between 3 and 5 In; used to protect long circuits and generators
 C – the maximum current release breaks between 5 and 10 In; used to protect main power supply cables and conventional consumers

- * Joining terminal: Combined screw clamp made of 1.5 cold extruded Q235-A material with additional coating
- * Plastic box – not keeping the burning material nylon PA66, UV rays wear resistance

Status indicator

- * Box permittivity strength: >18MV/m
- * Abnormal heating wear resistance and fire of the outer parts: 960°C / 3s

Heat resistance of internal non-electrical components: 850°C / 10 s

*** Maximum current release containing:**

- copper coil - composition: pure copper T2 type
- resistance: from 0.6 to 180m
- welding effort: <150 000 N/mm
- bimetal plate – composition: 5J158 to TB180 depending on the current
- thickness: 0.6mm (up to 40A) and 0.8mm (up to 63A)
- magnetic core – composition: coldly draw-plated metal wire (1Gr18Ni9)
- thickness: 1.15 to 2.24µm
- drawing effort: from 200 to 400N/mm
- contact head of the movable contact – composition: silver graphite CAg(5)
- dimension 3x3x0.8 (up to 40A) and 4x4x0.8 (up to 63A)
- static contact – composition: pure copper T2Y2
- composition of the contact head: silver graphite CAg(5)

*** Power supply (conducting)**

- power supply busbar 1P63, 3P63
- rigid conductors up to 25 mm
- flexible conductors up to 16 mm

* Tightening moment: 1.33Nm

Mounting:

- * vertical
- * DIN-rail
- * for mounting in housing or industrial environment without serious interference
- * ambient temperature: -5°C to + 40°C±2° C

Type	Rated current In (A)	Breaking capacity (kA)	Recommended sections of the conductors (mm ²)	Packing/Box (pcs)	Catalogue number Curve C	Catalogue number Curve B
C61N / 1A	1	6	1.0	12 / 240	41100N	41501N
C61N / 2A	2	6	1.0	12 / 240	41102N	41502N
C61N / 4A	4	6	1.0	12 / 240	41104N	41504N
C61N / 6A	6	6	1.0	12 / 240	41106N	41506N
C61N / 10A	10	6	1.5	12 / 240	41110N	41510N
C61N / 16A	16	6	2.5	12 / 240	41116N	41516N
C61N / 20A	20	6	2.5	12 / 240	41120N	41520N
C61N / 25A	25	6	4.0	12 / 240	41125N	41525N
C61N / 32A	32	6	6.0	12 / 240	41132N	41532N
C61N / 40A	40	6	10.0	12 / 240	41140N	41540N
C61N / 50A	50	6	10.0	12 / 240	41150N	41550N
C61N / 63A	63	6	16.0	12 / 240	41163N	41563N



Type	Rated current I_n (A)	Breaking capacity (kA)	Recommended sections of the conductor (mm ²)	Packing/Box (pcs)	Catalogue number Curve C	Catalogue number Curve B
C62N / 2A	2	6	1.0	6 / 120	41202N	41602N
C62N / 4A	4	6	1.0	6 / 120	41204N	41604N
C62N / 6A	6	6	1.0	6 / 120	41206N	41606N
C62N / 10A	10	6	1.5	6 / 120	41210N	41610N
C62N / 16A	16	6	2.5	6 / 120	41216N	41616N
C62N / 20A	20	6	2.5	6 / 120	41220N	41620N
C62N / 25A	25	6	4.0	6 / 120	41225N	41625N
C62N / 32A	32	6	6.0	6 / 120	41232N	41632N
C62N / 40A	40	6	10.0	6 / 120	41240N	41640N
C62N / 50A	50	6	10.0	6 / 120	41250N	41650N
C62N / 63A	63	6	16.0	6 / 120	41263N	41663N



Type	Rated current I_n (A)	Breaking capacity (kA)	Recommended sections of the conductor (mm ²)	Packing/Box (pcs)	Catalogue number Curve C	Catalogue number Curve B
C63N/2A	2	6	1.0	4 / 80	41302N	41702N
C63N/4A	4	6	1.0	4 / 80	41304N	41704N
C63N / 6A	6	6	1.0	4 / 80	41306N	41706N
C63N / 10A	10	6	1.5	4 / 80	41310N	41710N
C63N / 16A	16	6	2.5	4 / 80	41316N	41716N
C63N / 20A	20	6	2.5	4 / 80	41320N	41720N
C63N / 25A	25	6	4.0	4 / 80	41325N	41725N
C63N / 32A	32	6	6.0	4 / 80	41332N	41732N
C63N / 40A	40	6	10.0	4 / 80	41340N	41740N
C63N / 50A	50	6	10.0	4 / 80	41350N	41750N
C63N / 63A	63	6	16.0	4 / 80	41363N	41763N



Type	Rated current I_n (A)	Breaking capacity (kA)	Recommended sections of the conductor (mm ²)	Packing/Box (pcs)	Catalogue number Curve C	Catalogue number Curve B
C64N / 2A	2	6	1.0	3 / 60	41402N	41802N
C64N / 4A	4	6	1.0	3 / 60	41404N	41804N
C64N / 6A	6	6	1.0	3 / 60	41406N	41806N
C64N / 10A	10	6	1.5	3 / 60	41410N	41810N
C64N / 16A	16	6	2.5	3 / 60	41416N	41816N
C64N / 20A	20	6	2.5	3 / 60	41420N	41820N
C64N / 25A	25	6	4.0	3 / 60	41425N	41825N
C64N / 32A	32	6	6.0	3 / 60	41432N	41832N
C64N / 40A	40	6	10.0	3 / 60	41440N	41840N
C64N / 50A	50	6	10.0	3 / 60	41450N	41850N
C64N / 63A	63	6	16.0	3 / 60	41463N	41863N

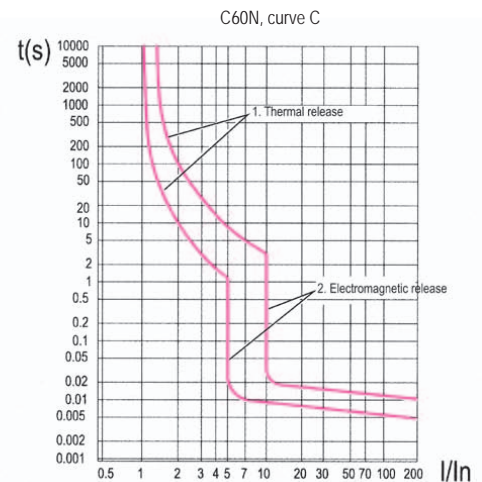
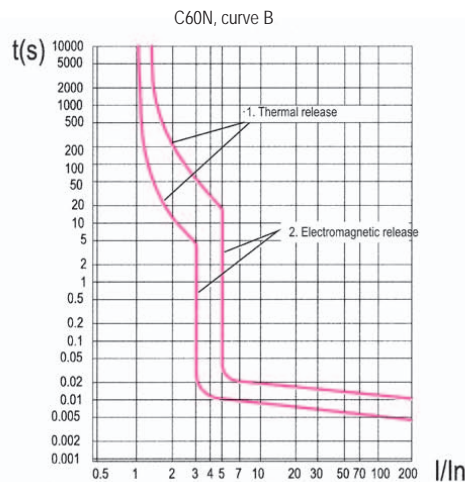

C100L — constructive series
 — number of poles (1;3)

C x — rated current
 — breaking curve C

Documents corresponding to the product:
 Standard EN60898-1
 EN 60947-2

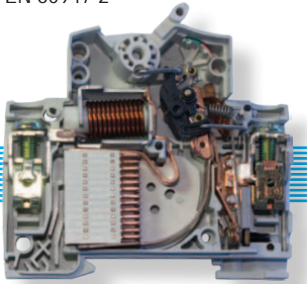

Functions:

- protection of the electrical circuits from overload or short circuits of the outer circuit
- it can be used as a device for commutation and control of electrical circuits
- in combination with auxiliary devices it allows remote control, commutation or indication of the protected circuit

Technical data:

- * Rated voltage: 230/400V; 50/60Hz
- * Breaking capacity (cycle O-CO) in accordance with standard EN 60 898-1: 10000A
- * Rated breaking capacity $I_{cs} = 75\% I_{cu}$
- * Isolating volatage: $\geq 2000V$, 1 min at impulse wave 1.2/50 μs
- * Electrical wear resistance (number of cycles): ≥ 4000
- * Mechanical wear resistance (number of cycles): ≥ 20000
- * Class of current limiting: 3
- * IP code: IP>20
- * Breaking curve: C

Mounting:

- * vertical
- * DIN-rail
- * possibility for labeling

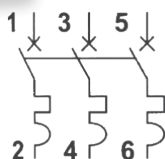

Type	Rated current In (A)	Breaking capacity (kA)	Recommended sections of the conductor (mm ²)	Packing/Box (pcs)	Catalogue number Curve C
C101L/6A	6	10	1.0	12 / 240	41101
C101L/10A	10	10	1.5	12 / 240	41103
C101L/16A	16	10	2.5	12 / 240	41105
C101L/20A	20	10	2.5	12 / 240	41107
C101L/25A	25	10	4.0	12 / 240	41108
C101L/32A	32	10	6.0	12 / 240	41109
C101L/40A	40	10	10.0	12 / 240	41111
C101L/50A	50	10	10.0	12 / 240	41112
C101L/63A	63	10	16.0	12 / 240	41113

Type	Rated current In (A)	Breaking capacity (kA)	Recommended sections of the conductor (mm ²)	Packing/Box (pcs)	Catalogue number Curve C
C102L/6A	6	10	1.0	6/120	41201
C102L/10A	10	10	1.5	6/120	41203
C102L/16A	16	10	2.5	6/120	41205
C102L/20A	20	10	2.5	6/120	41207
C102L/25A	25	10	4.0	6/120	41208
C102L/32A	32	10	6.0	6/120	41209
C102L/40A	40	10	10.0	6/120	41211
C102L/50A	50	10	10.0	6/120	41212
C102L/63A	63	10	16.0	6/120	41213

Type	Rated current In (A)	Breaking capacity (kA)	Recommended sections of the conductor (mm ²)	Packing/Box (pcs)	Catalogue number Curve C
C103L/6A	6	10	1.0	4 / 80	41301
C103L/10A	10	10	1.5	4 / 80	41303
C103L/16A	16	10	2.5	4 / 80	41305
C103L/20A	20	10	2.5	4 / 80	41307
C103L/25A	25	10	4.0	4 / 80	41308
C103L/32A	32	10	6.0	4 / 80	41309
C103L/40A	40	10	10.0	4 / 80	41311
C103L/50A	50	10	10.0	4 / 80	41312
C103L/63A	63	10	16.0	4 / 80	41313

C100M constructive series
 └── number of poles (1;2;3;4)

D x ─── rated current
 └── breaking curve C, D

Documents corresponding to the product:
 Standard EN60898-1
 EN 60947-2

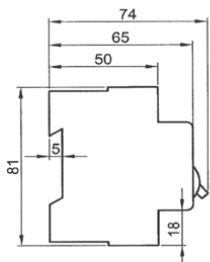
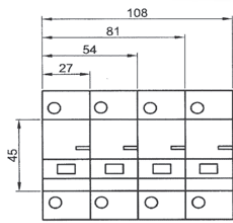
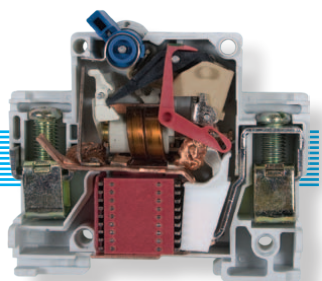

Functions:

- protection of the electrical circuits from overload or short circuits of the outer circuit
- it can be used as a device for commutation and control of electrical circuits
- in combination with auxiliary devices it allows remote control, commutation or indication of the protected circuit

Technical data:

- * Rated voltage: 230/400V; 50/60Hz
- * Breaking capacity (cycle O-CO) in accordance with standard EN 60 898-1: 10000A
- * Rated breaking capacity Ics= 75% Icu
- * Isolating volatage: ≥2000V
- * Electrical wear resistance (number of cycles): ≥4000
- * Mechanical wear resistance (number of cycles): ≥20000
- * Class of current limiting: 3
- * IP code: IP>20
- * Breaking curve: C,D
- * Joining terminal: flat (tunnel) screw terminal with composition 1.5 coldly draw-plated plane Q235 – A
- * Plastic box – not keeping the burning material nylon PA66, UV rays wear resistance
- * Box permitivity strength: >18MV/m
- * Abnormal heating wear resistance and fire of the outer parts: 960°C / 3s
- * Maximum current release containing:
 - copper coil - composition: pure copper T2 type
 - resistance: from 148 to 230m
 - welding effort: <400 N/
 - bimetal plate – composition: TB180/0.5
 - thickness: 0.8mm
 - magnetic core – composition: coldly draw-plated metal wire (1Gr18Ni9)
 - thickness: 1.15 to 2.24µm
 - drawing effort: 20N/mm²
 - contact head of the movable contact – composition: silver graphite CAg(5)
 - dimension 6x6x1
 - static contact – composition: pure copper T2Y2
 - composition of the contact head: silver graphite CAg(5)
- * Power supply (conducting)
 - power supply busbar
 - rigid conductors up to 50
 - flexible conductors up to 35
- * Tightening moment: 1.33Nm

Mounting:

- * vertical
- * DIN-rail
- * possibility for labeling
- * for mounting in industrial environment
- * ambient temperature: -5°C to + 40°C±2° C

Type	Number of poles	Rated current In (A)	Breaking capacity (kA)	Packing/Box (pcs)	Catalogue number Curve C	Catalogue number Curve D
C100M	1P	80	10	9 / 180	41180	41180D
C100M	1P	100	10	9 / 180	41190	41190D
C100M	1P	125	10	9 / 180	41195	41195D



Type	Number of poles	Rated current In (A)	Breaking capacity (kA)	Packing/Box (pcs)	Catalogue number Curve C	Catalogue number Curve D
C100M	2P	80	10	6 / 120	41280	41281
C100M	2P	100	10	6 / 120	41290	41291

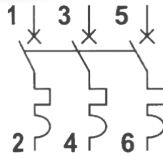

Type	Number of poles	Rated current In (A)	Breaking capacity (kA)	Packing/Box (pcs)	Catalogue number Curve C	Catalogue number Curve D
C100M	3P	80	10	4 / 60	41380	41381
C100M	3P	100	10	4 / 60	41390	41391

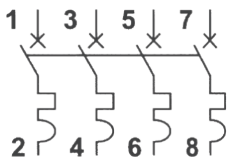

Type	Number of poles	Rated current In (A)	Breaking capacity (kA)	Packing/Box (pcs)	Catalogue number Curve C	Catalogue number Curve D
C100M	4P	80	10	3 / 60	41480	41481
C100M	4P	100	10	3 / 60	41490	41491

(C curve)

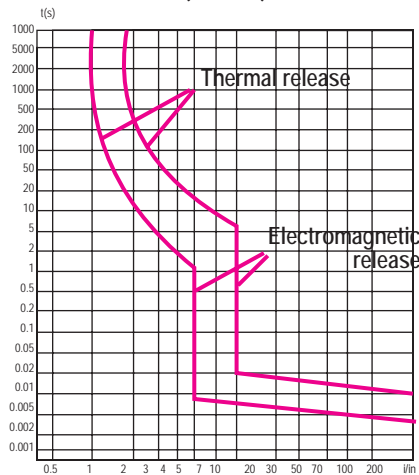

(D curve)

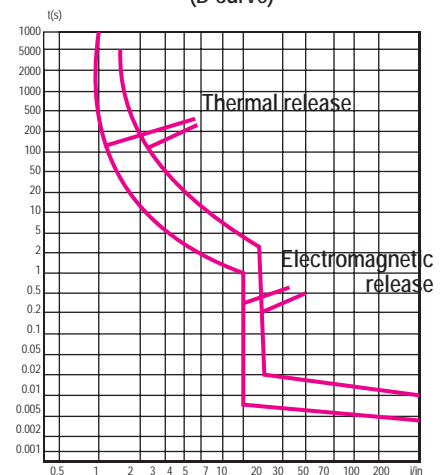

C60xDC constructive series
 _____ number of poles (1;2)

C x _____ rated current
 _____ breaking curve C

Documents corresponding to the product:

Standard EN60898-1
 EN 60898-2

Functions:

- for lowering constant current voltaic arc and use of the breaker at constant current consumer protection
- protection of the electrical circuits from overload or short circuit of the outer circuit at alternating current and constant current power supply circuits
- for commutation and control of electrical circuits
- in combination with auxiliary alternating current devices for remote control, commutation or indication of the protected circuit
- for mounting in industrial buildings
- for protection of consumers generating short circuit currents to 6000 A at alternating current power supply

Technical data:

- * Rated voltage: 240V; AC/DC
- * Breaking capacity (cycle O -CO) in accordance with standard EN 60 898- 1: 6000A
- * Rated breaking capacity $I_{cs}=75\% I_{cu}$
- * Insulating voltage: $\geq 2000V$
- * Electrical wear resistance (number of cycles): ≥ 4000
- * Mechanical wear resistance (number of cycles): ≥ 20000
- * Class of current limiting: 3
- * IP code: IP>20
- * Breaking curve: C – the maximum current release breaks between 5 and 10 I_n ; used to protect power supply cables and conventional consumers
- * Joining terminal: flat (tunnel) screw terminal with composition 1.5 coldly draw-plated plane Q235 – A
- * Plastic box – not keeping the burning material nylon PA66, UV rays wear resistance
- * Box permittivity strength: $>18MV/m$
- * Abnormal heating wear resistance and fire of the outer parts: $960^\circ C / 3s$
- * Maximum current release containing:
 - copper coil - composition: pure copper T2 type
 - resistance: from 0.6 to 180m
 - welding effort: $<150\ 000\ N/mm$
 - bimetal plate – composition: 5J158 to TB180 according to the current
 - thickness: 0.6mm (up to 40A) and 0.8mm (up to 63A)
 - magnetic core – composition: coldly draw-plated metal wire (1Gr18Ni9)
 - thickness: 1.15 to 2.24 μm
 - drawing effort: from 200 to 400N/mm
 - contact head of the movable contact – composition: silver graphite CAg(5)
 - dimension 3x3x0.8 (up to 40A) and 4x4x0.8 (up to 63A)
 - static contact – composition: pure copper T2Y2
 - composition of the contact head: silver graphite CAg(5)
 - metal magnetic plate for lowering the constant current arc
- * Conducting:
 - power supply busbar 1P63
 - rigid conductors up to 25 mm
 - flexible conductors up to 16 mm
- * Tightening moment: 1.33Nm

Mounting

- * vertical
- * DIN-rail
- * for mounting in housing or industrial environment without serious current interference
- * Ambient temperature: $-5^\circ C$ to $+ 40^\circ C \pm 2^\circ C$

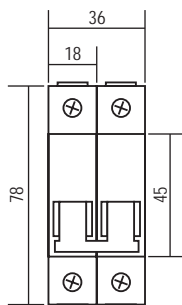
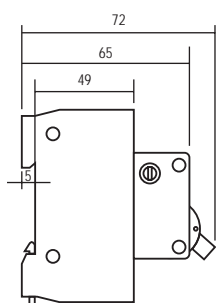

Type	Rated current I _n (A)	Breaking capacity (kA)	Recommended sections of the conductor (mm ²)	Packing/Box (pcs)	Catalogue number Curve C
61DC / 1A	1	6	1.0	12 / 240	41164
61DC / 2A	2	6	1.0	12 / 240	41165
61DC / 4A	4	6	1.0	12 / 240	41166
61DC / 6A	6	6	1.0	12 / 240	41167
61DC / 10A	10	6	1.5	12 / 240	41168
61DC / 16A	16	6	2.5	12 / 240	41169
61DC / 20A	20	6	2.5	12 / 240	41170
61DC / 25A	25	6	4.0	12 / 240	41171
61DC / 32A	32	6	6.0	12 / 240	41172
61DC / 40A	40	6	10.0	12 / 240	41173
61DC / 50A	50	6	10.0	12 / 240	41174
61DC / 63A	63	6	16.0	12 / 240	41175



Type	Rated current I _n (A)	Breaking capacity (kA)	Recommended sections of the conductor (mm ²)	Packing/Box (pcs)	Catalogue number Curve C
62DC / 2A	2	6	1.0	6 / 120	41176
62DC / 4A	4	6	1.0	6 / 120	41177
62DC / 6A	6	6	1.0	6 / 120	41178
62DC / 10A	10	6	1.5	6 / 120	41179
62DC / 16A	16	6	2.5	6 / 120	41181
62DC / 20A	20	6	2.5	6 / 120	41182
62DC / 25A	25	6	4.0	6 / 120	41183



Functions:

- protection of the electrical circuits from overload or short circuit of the outer circuit
- it can be used as a device for commutation and control of electrical circuits
- it breaks simultaneously the lead and the neutral conductor as the heat protection is only at the lead conductor

Technical data:

- * Rated voltage: 230V; 50/60Hz
- * Breaking capacity (cycle O-CO) in accordance with standard EN 60 898-1: 4500 A
- * Rated breaking capacity Ics = 50% Icu
- * Insulating voltage: ≥2000V
- * IP code: IP>20
- * Breaking curve: C – the maximum current release breaks between 5 and 10 In; used to protect main power supply cables and conventional consumers

Connecting:

- * Joining terminal: flat (tunnel) screw terminal
- * Power supply (conducting):
 - power supply busbar DP1N
 - flexible or rigid conductor
- * Mounting: on DIN-rail

Circuit breakers DP1N (1P+N) - SIGMA design

Type	Rated current In (A)	Breaking capacity (kA)	Recommended sections of the conductors (mm ²)	Packing/Box (pcs)	Catalogue number Curve C
DP1N / 6	6	4.5	1.0	12 / 240	41006
DP1N / 10	10	4.5	1.5	12 / 240	41010
DP1N / 16	16	4.5	2.5	12 / 240	41016
DP1N / 20	20	4.5	2.5	12 / 240	41020
DP1N / 25	25	4.5	4.0	12 / 240	41025
DP1N / 32	32	4.5	6.0	12 / 240	41032



Type designation:
MN - constructive series
number of poles - 1
**Documents corresponding
to the product:**
Standard EN60898-1

Combined voltage circuit-breaker MN2

Functions:

- when the voltage is reduced below 170V operation is initiated and the automatic switch is turned off
- when the voltage is increased above 270V operation is initiated and the automatic switch is turned off
- allows manual turning on of the switch after powering is restored
- indication of the position of the device

Technical characteristics:

- * Rated voltage: 230/400V; 50/60Hz
- * Insulation voltage: $\geq 2000V$
- * Protection ratio: IP>20

Connection method:

- * Double connector: flat (tunnel) screw connector
- * Feeding (conducting):
- flexible conductors up to 1.5mm²
- * Tightening moment of the screw: 1.33Nm

Mounting:

- * vertical, by means of two pins attached to the rivets of the circuit-breaker, while the operating mechanism is connected to the switching off mechanism of the circuit breaker after the sealing lid is demounted

Type	Rated voltage	Type breaker	Packing/Box (pcs)	Catalogue number
ELMARK MN 2 60	230V	C60	12 / 240	41909



Type designation:
MX - constructive series
number of poles - 1
**Documents corresponding
to the product:**
Standard EN60898-1

Shunt release MX (independent release)

Functions:

- remote circuit breaker switching off at voltage feed
- allows manual switching on of the breaker at voltage recovery
- indication of the device's location

Technical data:

- * Rated voltage: 230V; 50/60Hz
- * Isolating voltage: $\geq 2000V$
- * IP code: IP>20

Connecting:

- * Joining terminal: flat (tunnel) screw terminal
- * Power supply (conducting):
- flexible conductors up to 1.5mm²
- * Tightening moment: 1.33Nm
- * The power supply of the release is accomplished at the outlet of the breaker

Mounting:

- * vertical, clamps with two pins to the breaker's rivets and the executive mechanism is joined up to the switching mechanism of the breaker after dismantling the seal cover

Type	Rated voltage	Type breaker	Packing/Box (pcs)	Catalogue number
ELMARK MX 60	230V	C60	12 / 240	41902



Type designation:
OF - constructive series
number of poles - 1
**Documents corresponding
to the product:**
Standard EN60898-1

Auxiliary contact OF

Functions:

- at circuit breaker switching off it sends a signal to the control or signalization system
- indication of the location of the auxiliary contact and the breaker

Technical data:

- * Rated voltage: 230V
- * Isolating voltage: $\geq 2000V$
- * Ingress protecting rating: IP>20

Connecting:

- * Joining terminal: flat (tunnel) screw terminal
- * Power supply (conducting): - flexible conductors up to 1.5mm²

Mounting:

- * vertical, clamps with two pins to breaker's rivets, and the executive mechanism is joined up to the switching mechanism of the breaker after dismantling the seal cover

Type	Rated voltage	Type breaker	Packing/Box (pcs)	Catalogue number
ELMARK OF 60	230V	C60	12 / 240	41901
ELMARK SD100	230V	C100M	12 / 240	41905



Documents corresponding to the product:
Standard EN 60947-3 and IEC947-3

Functions:

- switching on/off heavy loaded electrical circuits
- breaking of electrical circuits
- can be used as a main breaker

Technical data:

- * Rated voltage: 230/400V; 50/60Hz
- * Joining terminal: flat (tunnel) screw terminal
- * Connecting: power supply busbar, rigid or flexible conductors
- * Tightening moment: 1.33Nm
- * Isolating voltage: $\geq 500V$
- * Electrical wear resistance (number of cycles): ≥ 10000
- * Mechanical wear resistance (number of cycles): ≥ 20000
- * IP code: IP>20
- * Mounting: DIN-rail
- * Plastic material of UV rays
- * Ambient temperature: $-20^{\circ}C + 55^{\circ}C$

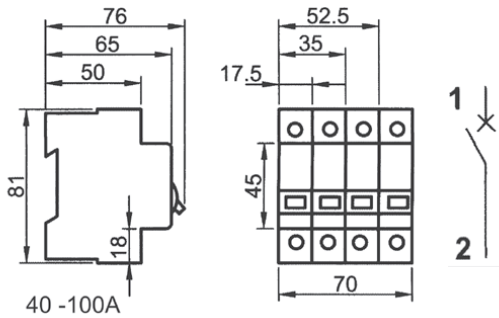

Type	Number of poles	Rated current In (A)	Recommended sections of the conductors (g/mm ²)	Packing/Box (pcs)	Catalogue number
ISS	1P	40	10	12 / 240	41914
ISS	1P	63	16	12 / 240	41911
ISS	1P	80	25	12 / 240	41912
ISS	1P	100	35	12 / 240	41913



Type	Number of poles	Rated current In (A)	Recommended sections of the conductors (g/mm ²)	Packing/Box (pcs)	Catalogue number
ISS	2P	40	10	6 / 120	41924
ISS	2P	63	16	6 / 120	41921
ISS	2P	80	25	6 / 120	41922
ISS	2P	100	35	6 / 120	41923

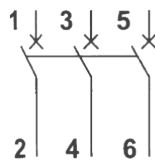

Type	Number of poles	Rated current In (A)	Recommended sections of the conductors (g/mm ²)	Packing/Box (pcs)	Catalogue number
ISS	3P	40	10	4 / 80	41934
ISS	3P	63	16	4 / 80	41931
ISS	3P	80	25	4 / 80	41932
ISS	3P	100	35	4 / 80	41933

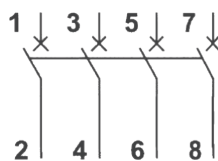

Type	Number of poles	Rated current In (A)	Recommended sections of the conductors (g/mm ²)	Packing/Box (pcs)	Catalogue number
ISS	4P	40	10	3 / 60	41944
ISS	4P	63	16	3 / 60	41941
ISS	4P	80	25	3 / 60	41942
ISS	4P	100	35	3 / 60	41943

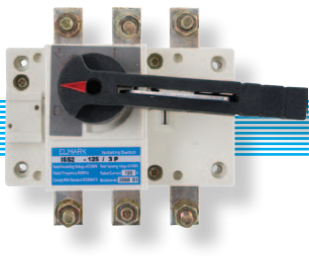

Documents corresponding to the product:
Standard EN 60947-1
EN 60947-3 and IEC 60947-6

The series three- and four-pole load isolating switch ISS2 xxx are produced for mounting in main electrical boards for disconnection of the circuits, switching on of generators because of the fact they are not affected by the frequency variations. High mechanical strength and resistance to circulation. Simple and secure management. There is a possibility for the products to be produced with an window for visible disconnection.

Functions:

- switching on and off of electrical circuits under load
- disconnection of electrical circuits
- used as main circuit-breaker
- resistant to high voltages, to short circuits in the protected circuit
- it has no protective function

Technical features:

- * Rated voltage: not higher than 660V; 50/60Hz
- * Double connector: screw connection
- * Connection: solid or flexible conductors
- * Insulation voltage: $\geq 1000V$
- * Resistance to impulse voltage: 8000V
- * Electrical endurance (number of cycles): $\geq 5\ 000$
- * Mechanical endurance (number of cycles): $\geq 10\ 000$
- * Protection ratio: IP>20
- * Mounting method: to a surface by means of bolts
- * Plastic resistant to UV rays
- * Ambient temperature: $-20^{\circ}+40^{\circ}C$

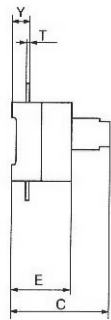
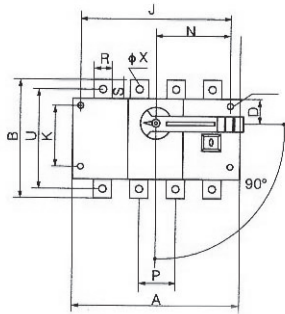

Type	Dimensions											
	A	B	C	D	E	J	J1	K	R	S	T	Y
ISS2-125/3	140	135	125	27	73	120	120	65	20	25	3.5	25
ISS2-125/4	170	135	125	27	73	150	150	65	20	25	3.5	25
ISS2-160/3	140	135	125	27	73	120	120	65	20	25	3.5	25
ISS2-160/4	170	135	125	27	73	150	150	65	20	25	3.5	25
ISS2-250/3	180	170	138	35	86	160	160	90	25	30	3.5	25
ISS2-250/4	230	170	138	35	86	210	210	90	25	30	3.5	25
ISS2-400/3	230	240	165	50	110	210	210	140	32	40	5	37
ISS2-400/4	295	240	165	50	110	275	275	140	32	40	5	37
ISS2-630/3	230	260	165	50	110	210	210	140	40	50	6	37
ISS2-630/4	295	260	165	50	110	275	275	140	40	50	6	37
ISS2-800/3	378	312	240	50	140	353	353	175	60	56	8	48
ISS2-800/4	498	312	240	50	140	473	473	175	60	56	8	48

Type	Rated current In (A)	Maximum breaking capacity Icu (A)	Tightening moment (Nm)	Packing/Box (pcs)	Catalogue number three-pole	Catalogue number four-pole
ISS2-125in	125	1250	6.5	1 / 12	41951	41961
ISS2-125out	125	1250	6.5	1 / 12	41952	41962
ISS2-160in	160	1250	6.5	1 / 12	41953	41963
ISS2-160out	160	1250	6.5	1 / 12	41954	41964
ISS2-250in	250	2000	10	1 / 6	41955	41965
ISS2-250out	250	2000	10	1 / 6	41956	41966
ISS2-400in	400	3200	14.5	1 / 2	41957	41967
ISS2-630in	630	4000	14.5	1 / 2	41958	41968
ISS2-800in	800	1000	27	1 / 2	41959	41969

Note: ISS2-xxx in – load circuit-breaker for mounting in the interior of a board
ISS2-xxx out – load circuit-breaker with an extended lever for mounting on the front panel of the board

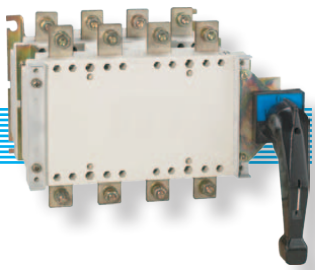

Documents corresponding to the product:
Standard EN 60947-1
EN 60947-3 and IEC 60947-6

The series three- and four-pole load isolating switch EQ 2 M xxx are produced for mounting in main electrical boards for disconnection of the circuits, manual switching between two power supplies or switching ON of generators because of the fact they are not affected by the frequency variations. High mechanical strength and resistance to circulation. Simple and secure management. There is a possibility for the products to be produced with an window for visible disconnection.

Functions:

- switching on and off of low voltage electrical circuits under load
- disconnection of the electrical circuit from one of the power supplies, while providing immediately switching to the other
- used as main switch
- resistant to high voltages, to short circuits in the protected circuit
- it has no protective function

Technical characteristics:

- * Rated voltage: not higher than 660V; 50/60Hz
- * Double connector: screw connection
- * Connection: hard or flexible conductors
- * Insulation voltage: $\geq 1000V$
- * Resistance to impulse voltage: 8000V
- * Electrical endurance (number of cycles): $\geq 5\ 000$
- * Mechanical endurance (number of cycles): $\geq 10\ 000$
- * Protection ratio: IP>20
- * Mounting method: to a surface by means of bolts
- * Plastic resistant to UV rays
- * Ambient temperature: $-20^{\circ}\pm 40^{\circ}C$
- * Option for moving the handle on the front panel of the board
- * Small size
- * Indication which of the two supplies is operating

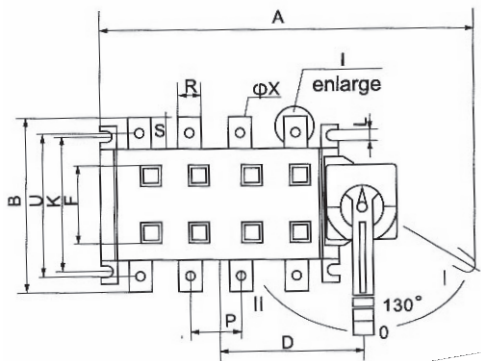

Type	Dimensions												
	A	B	C	D	E	J	J1	K	R	S	T	Y	Y1
EQ2M-160/3	270	135	212	89	150	120	65	95	20	25	3.5	55	25
EQ2M-160/4	300	135	212	104	150	150	65	95	20	25	3.5	55	25
EQ2M-250/3	307	170	260	110	180	160	65	115	25	30	3.5	70	25
EQ2M-250/4	357	170	260	135	180	210	65	115	25	30	3.5	70	25
EQ2M-400/3	372	240	297	150	236	210	77	180	32	40	5	83	37
EQ2M-400/4	432	240	297	180	236	275	77	180	32	40	5	83	37
EQ2M-630/3	372	240	297	150	236	210	77	180	40	50	6	83	37
EQ2M-630/4	432	240	297	180	236	275	77	180	40	50	6	83	37
EQ2M-800/3	372	240	297	150	236	210	77	180	60	56	8	83	48
EQ2M-800/4	432	240	297	180	236	275	77	180	60	56	8	83	48

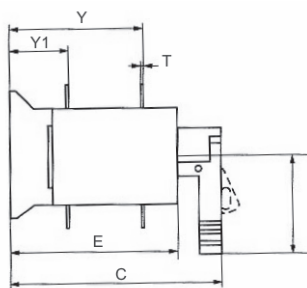

Type	Rated current In (A)	Maximum breaking capacity Icu (A)	Tightening moment (Nm)	Packing/Box (pcs)	Catalogue number three-pole	Catalogue number four-pole
EQ2M-160	160	1250	6.5	1 / 4	44641	44641P
EQ2M-250	250	2000	10	1 / 2	44642	44642P
EQ2M-400	400	3200	14.5	1 / 2	44643	44643P
EQ2M-630	630	4000	14.5	1 / 2	44644	44644P
EQ2M-800	800	1000	27	1 / 2	44645	44645P

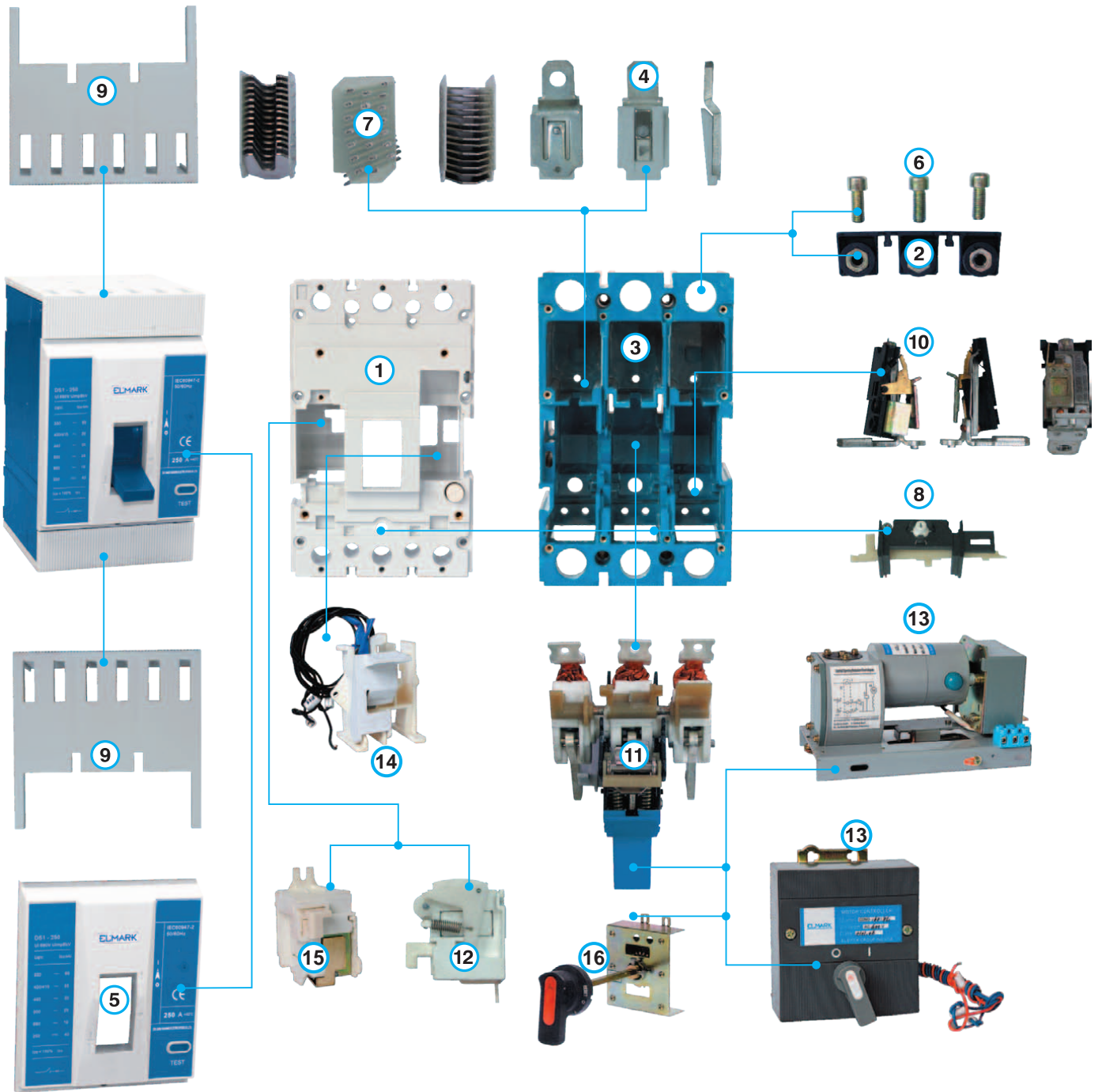

- ① COVER
- ② TERMINALS
- ③ NON-FLAMABLE BASE
- ④ STATIC CONTACTS
- ⑤ PART FROM THE COVER
- ⑥ SCREWS FOR TERMINALS
- ⑦ ARC CHAMBERS
- ⑧ ELEMENT FOR ADJUSTMENT
- ⑨ TERMINAL PLASTIC PLATE
- ⑩ CONTACTS WITH BIMETAL PLATES
- ⑪ THERMAL SYSTEM WITH MOVABLE CONTACTS
- ⑫ UNDER VOLTAGE RELEASE - UVR (accessory)
- ⑬ REMOTE CONTROL – electrical (accessory)
- ⑭ AUXILIARY CONTACT (accessory)
- ⑮ SHUNT RELEASE (accessory)
- ⑯ REMOTE CONTROL – manual (accessory)

Documents corresponding to the product:
Standard EN 60947-1
EN 60947-2

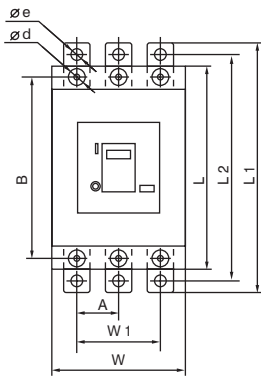
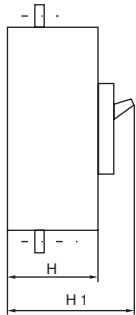

Functions:

- switching on/off heavy loaded electrical circuits
- breaking of electrical circuits and control of powerful consumers
- can be used as a main breaker in housing or industrial distributing installations
- endures high currents of short circuit in the protected circuit
- remarkable with high reliability of current characteristics
- control: manual
- possibility for auxiliary devices mounting for automation

Technical data:

- * Rated operating voltage: 690V; 50/60Hz
- * Isolating voltage: 2000V
- * Surge voltage wear resistance: $\geq 8000V$
- * Joining terminal: flat (tunnel) screw terminal for the breakers up to 160A and a bolt connection for the breakers from 250A to 1600A
- * Connecting:
 - rigid or flexible conductors
 - front conductors joining
 - possibility for mounting to lengthening terminal
- * Plastic elements
 - not keeping the burning material nylon PA66
 - box permitivity strength: $> 16MV/m$
- * Abnormal heating wear resistance and fire of the outer parts: $960^{\circ}C$
- * Static contacts – alloy: pure copper T2Y2
- contact head: silver graphite CAg(5)
- thickness: depends on the current
- * Tightening moment: 1.33Nm
- * Electrical wear resistance (number of cycles): ≥ 10000
- * Mechanical wear resistance (number of cycles): ≥ 20000
- * IP code: IP>20
- * Mounting:
 - joining with bolts
 - mounting position: vertical
- * Plastic material of UV rays and non-flammable
- * Test button
- * Ambient temperature: $-20^{\circ} \pm 55^{\circ}C$

Type	Overall dimensions (mm)					Installation dimensions (mm)					
	W	L	H	L1	H1	A	B	W1	L2	Ø d	Ø e
DS1-125	76.2	120	70		90	25	100	50		4	
DS1-160	90	120	70		93	30	100	60		5	
DS1-250	105	170	104	238	143.5	35	139	70	210	6	8.5
DS1-400	140	257	104	316	144	44	214	87.5	285	6	11
DS1-630	210	275	104	310	172	70	230	140	280	6	11
DS1-800	210	275	104	347	172	70	230	140	307	6	16
DS1-1600	210	410	140	410	210	70	300	140	350	10	12



Type	Rated current In (A)	Operating breaking capacity (kA) Ics	Maximum breaking capacity (kA) Icu		Thermal current adjustment (A)	Section of the conductor (mm²)	Packing/Box (pcs)	Catalogue number
			400V	690V				
DS1-125	40	16	25	10	fixed	16	1 / 20	44040
DS1-125	50	16	25	10	fixed	16	1 / 20	44050
DS1-125	63	16	25	10	fixed	25	1 / 20	44063
DS1-125	80	16	25	10	fixed	25	1 / 20	44080
DS1-125	100	16	25	10	fixed	35	1 / 20	44090
DS1-125	125	16	25	10	fixed	50	1 / 20	44125



Type	Rated current In (A)	Operating breaking capacity (kA) Ics	Maximum breaking capacity (kA) Icu		Thermal current adjustment (A)	Section of the conductor (mm ²)	Packing/Box (pcs)	Catalogue number
			400V	690V				
DS1 - 160	63	22	35	15	44 - 63	25	1 / 16	44163
DS1 - 160	80	22	35	15	56 - 80	25	1 / 16	44164
DS1 - 160	100	22	35	15	70 - 100	50	1 / 16	44165
DS1 - 160	125	22	35	15	88 - 125	50	1 / 16	44166
DS1 - 160	160	22	35	15	112 - 160	70	1 / 16	44160



Type	Rated current In (A)	Operating breaking capacity (kA) Ics	Maximum breaking capacity (kA) Icu		Thermal current adjustment (A)	Section of the conductor (mm ²)	Packing/Box (pcs)	Catalogue number
			400V	690V				
DS1 - 250	200	35	50	15	140 - 200	120	1 / 6	44200
DS1 - 250	250	35	50	15	175 - 250	120	1 / 6	44250



Type	Rated current In (A)	Operating breaking capacity (kA) Ics	Maximum breaking capacity (kA) Icu		Thermal current adjustment (A)	Section of the conductor (mm ²)	Packing/Box (pcs)	Catalogue number
			400V	690V				
DS1 - 400	315	50	65	25	fixed	240	1 / 3	44315
DS1 - 400	400	50	65	25	fixed	240	1 / 3	44401



Type	Rated current In (A)	Operating breaking capacity (kA) Ics	Maximum breaking capacity (kA) Icu		Thermal current adjustment (A)	Section of the conductor (mm ²)	Packing/Box (pcs)	Catalogue number
			400V	690V				
DS1 - 630	500	65	75	25	fixed	2 x 185	1 / 2	44500
DS1 - 630	630	65	75	25	fixed	2 x 185	1 / 2	44630
DS1 - 800	800	75	85	30	fixed	2 x 240	1 / 2	44800



Type	Rated current In (A)	Max. breaking capacity (kA) Icu	Operating breaking capacity (kA) Ics	Section of the power supply conductor (mm ²)	Protection from overload	Packing/Box (pcs)	Catalogue number
DS1 - 1250	1000	85	65	240	fixed	1 / 1	44000
DS1 - 1250	1250	85	65	240	fixed	1 / 1	44502

Documents corresponding to the product:
Standard EN 60947-1
EN 60947-2



Functions:

- switching on/off heavy loaded electrical circuits
- breaking of electrical circuits and control of powerful consumers
- can be used as a main breaker in housing or industrial distributing installations
- endures high currents of short circuit in the protected circuit
- remarkable with high reliability of current characteristics
- control: manual
- possibilities for electrical module parameters adjustment through direct modules (combination of keys) thus providing accurate protection from overload and short circuit
- simultaneous protection of the three phases
- possibility for auxiliary devices mounting for automation
- contactor for TT test 15V DC

Technical data:

- * Rated operating voltage: 690V; 50/60Hz
- * Isolating voltage: 2000V
- * Surge voltage wear resistance: ≥8000V
- * Joining terminal: flat (tunnel) screw terminal
- * Connecting:
 - rigid or flexible conductors
 - front conductors joining
 - possibility for mounting to lengthening terminal
- * Electrical wear resistance (number of cycles): ≥10000
- * Mechanical wear resistance (number of cycles): ≥20000
- * IP code: IP>20
- * Abnormal heating wear resistance and fire of the outer parts: 960°C
- * Mounting:
 - joining with bolts
 - mounting position: vertical
- * Plastic material of UV rays and non-flammable
- * Test button
- * Ambient temperature: -20°÷55°C

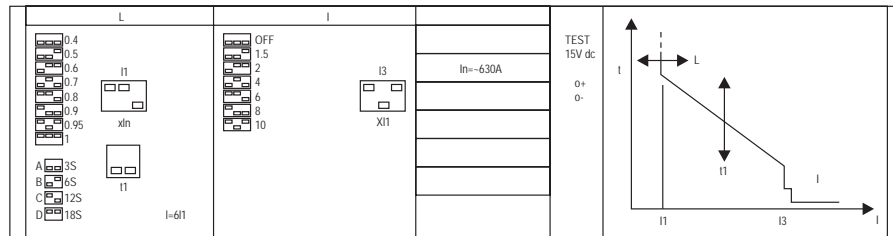

Protecting functions:

Function L – step adjustment for protection against overload. Adjustment of the operating current $I1=0.4+1xI_n$ with discrete coefficients as the value can be 0.4; 0.5; 0.6; 0.7; 0.8; 0.9; 0.95 and 1
 Time delay adjustment $t1$ of the protection against overload – step adjustment with four values A-3s; B-6s; C-12s; D-18s when current is $I=6I1$. The diagram of the current curves is presented on fig.1
 Adjustment of the transitory protection current against short circuit $I3=X \times I1$ where X can take discrete value OFF; 1.5; 2; 4; 6; 8; 10

Type	Rated current I_n (A)	Operating breaking capacity (kA) I_{cs}	Maximum breaking capacity (kA) I_{cu}		Thermal current adjustment (A)	Section of the conductor (mm ²)	Packing/Box (pcs)	Catalogue number
			400V	690V				
DS1 - 400E	400	50	65	25	160 - 400	240	1 / 3	44940
DS1 - 630E	630	65	75	25	252 - 630	2x185	1 / 2	44963
DS1 - 800E	800	65	75	30	320 - 800	2x240	1 / 2	44980
DS1 - 1250E	1000	75	85	50	400 - 1000	2x240	1 / 1	44999
DS1 - 1250E	1250	75	85	50	500 - 1250	2x240	1 / 1	44925
DS1 - 1600E	1600	75	85	50	640 - 1600	2x240	1 / 1	44960

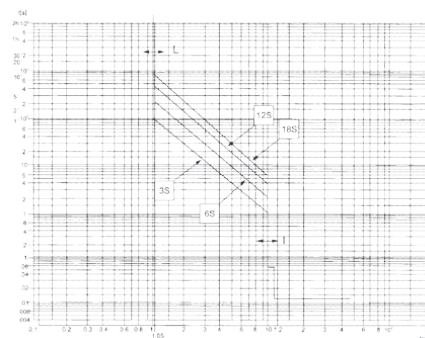

fig. 1

According to the way of mounting the auxiliary devices can be divided into two groups:

- internal devices – accessories for whose mounting it is necessary to dismount the cover of the breakers and fix them in specially designed jacks
- external devices – they are mounted right on the top cover of the breaker

INTERNAL DEVICES

Auxiliary contact (OF)

The device changes its condition conformably to the breaker's condition; it has a NO and a NC contactor.

Technical data:

- for breakers up to 160A operating current through the auxiliary contact: 3A
- for breakers from 250 to 800A operating current through the auxiliary contact: 6A
- available joining conductors
- labeling of the cables

Mounting:

Mounted in a special jack after cover dismounting

Note:

The breakers are offered with mounted accessory

Connecting:

Connected with the operative system through the provided conductors

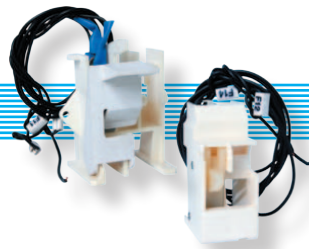

Documents corresponding to the product:
Standard EN 60947-1
EN 60947-2

Type of the breaker	Catalogue number
DS1 125/40+OF	44301
DS1 125/50+OF	44302
DS1 125/63+OF	44303
DS1 125/80+OF	44304
DS1 125/100+OF	44305
DS1 125/125+OF	44306

Type of the breaker	Catalogue number
DS1 160/160+OF	44307
DS1 250/200+OF	44308
DS1 250/250+OF	44309
DS1 400/400+OF	44310
DS1 630/500+OF	44311
DS1 630/630+OF	44312

Type of the breaker	Catalogue number
DS1 800/800+OF	44313
DS1 1600/1000+OF	44314
DS1 1600/1250+OF	44451
DS1 1600/1600+OF	44316

Shunt release (MX)

The device is used for remote control of breakers as at voltage signal it starts operating and switches off the breaker to which it is mounted

Technical data:

- rated operating voltage: 230/400V 50/60Hz
- electromagnetic coil 100VA for breakers up to 400A
- electromagnetic coil 150VA for breakers 630-800A
- available joining conductors

Mounting:

Mounted in a special jack after cover dismounting

Connecting:

Connected with the operative system through the provided conductors

Note: The breakers are offered with mounted accessory

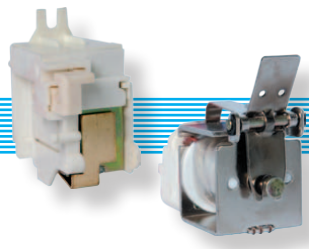

Type of the breaker	Operating voltage (V)	Catalogue number
DS1 125/40+MX	400	44317
DS1 125/40+MX	230	44318
DS1 125/40+MX+OF	400	44319
DS1 125/40+MX+OF	230	44320
DS1 125/50+MX	400	44321
DS1 125/50+MX	230	44322
DS1 125/50+MX+OF	400	44323
DS1 125/50+MX+OF	230	44324
DS1 125/63+MX	400	44326
DS1 125/63+MX	230	44327
DS1 125/63+MX+OF	400	44328
DS1 125/63+MX+OF	230	44330
DS1 125/80+MX	400	44331
DS1 125/80+MX	230	44332
DS1 125/80+MX+OF	400	44334
DS1 125/80+MX+OF	230	44335
DS1 125/100+MX	400	44336
DS1 125/100+MX	230	44337
DS1 125/100+MX+OF	400	44338
DS1 125/100+MX+OF	230	44339
DS1 125/125+MX	400	44340
DS1 125/125+MX	230	44341
DS1 125/125+MX+OF	400	44342
DS1 125/125+MX+OF	230	44343
DS1 160/100+MX	400	44463
DS1 160/100+MX	230	44464
DS1 160/100+MX+OF	400	44465
DS1 160/100+MX+OF	230	44466

Type of the breaker	Operating voltage (V)	Catalogue number
DS1 160/160+MX	400	44333
DS1 160/160+MX	230	44344
DS1 160/160+MX+OF	400	44345
DS1 160/160+MX+OF	230	44346
DS1 250/200+MX	400	44347
DS1 250/200+MX	230	44348
DS1 250/200+MX+OF	400	44349
DS1 250/200+MX+OF	230	44350
DS1 250/250+MX	400	44351
DS1 250/250+MX	230	44352
DS1 250/250+MX+OF	400	44353
DS1 250/250+MX+OF	230	44354
DS1 400/315+MX	400	44467
DS1 400/315+MX	230	44468
DS1 400/315+MX+OF	400	44469
DS1 400/315+MX+OF	230	44470
DS1 400/400+MX	400	44355
DS1 400/400+MX	230	44356
DS1 400/400+MX+OF	400	44357
DS1 400/400+MX+OF	230	44358
DS1 630/500+MX	400	44359
DS1 630/500+MX	230	44360
DS1 630/500+MX+OF	400	44361
DS1 630/500+MX+OF	230	44362
DS1 630/630+MX	400	44363
DS1 630/630+MX	230	44364
DS1 630/630+MX+OF	400	44365
DS1 630/630+MX+OF	230	44366

Type of the breaker	Operating voltage (V)	Catalogue number
DS1 800/800+MX	400	44367
DS1 800/800+MX	230	44368
DS1 800/800+MX+OF	400	44369
DS1 800/800+MX+OF	230	44370
DS1 1250/1000+MX	400	44371
DS1 1250/1000+MX	230	44372
DS1 1250/1000+MX+OF	400	44373
DS1 1250/1000+MX+OF	230	44374
DS1 1250/1250+MX	400	44375
DS1 1250/1250+MX	230	44376
DS1 1250/1250+MX+OF	400	44377
DS1 1250/1250+MX+OF	230	44378
DS1 1600/1600+MX	400	44379
DS1 1600/1600+MX	230	44380
DS1 1600/1600+MX+OF	400	44381
DS1 1600/1600+MX+OF	230	44382
DS1 400/3300+MX	400	44451
DS1 400/3300+MX	230	44452
DS1 400/3300+MX+OF	400	44453
DS1 400/3300+MX+OF	230	44454
DS1 630/3300+MX	400	44455
DS1 630/3300+MX	230	44456
DS1 630/3300+MX+OF	400	44457
DS1 630/3300+MX+OF	230	44458
DS1 800/3300+MX	400	44459
DS1 800/3300+MX	230	44460
DS1 800/3300+MX+OF	400	44461
DS1 800/3300+MX+OF	230	44462

Under voltage release (MN)

The device switches off and/or does not allow the switching on of the breaker to which it is mounted at power breakdown or voltage decrease under certain limits

Technical data:

- operating voltage: 230/400V 50Hz
- electromagnetic coil 6VA for breakers up to 400A
- electromagnetic coil 10VA for breakers 630-800A
- available joining conductors
- switches off at voltage decrease under 75% of the operating

Mounting:

Mounted in a special jack after cover dismounting

Note: The breakers are offered with mounted accessory

Connecting:

Connected with the operative system through the provided conductors



MN for DS1 - 125-160

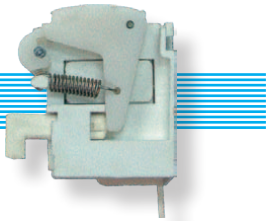

MN for DS1 - 250-800

Type of the breaker	Operating voltage (V)	Catalogue number	Type of the breaker	Operating voltage (V)	Catalogue number
DS1 125/40+MN	400	44383	DS1 400/315+MN+OF	400	44481
DS1 125/40+MN	230	44384	DS1 400/315+MN+OF	230	44482
DS1 125/40+MN+OF	400	44385	DS1 400/400+MN	400	44423
DS1 125/40+MN+OF	230	44386	DS1 400/400+MN	230	44424
DS1 125/50+MN	400	44387	DS1 400/400+MN+OF	400	44425
DS1 125/50+MN	230	44388	DS1 400/400+MN+OF	230	44426
DS1 125/50+MN+OF	400	44389	DS1 630/500+MN	400	44427
DS1 125/50+MN+OF	230	44390	DS1 630/500+MN	230	44428
DS1 125/63+MN	400	44391	DS1 630/500+MN+OF	400	44429
DS1 125/63+MN	230	44392	DS1 630/500+MN+OF	230	44430
DS1 125/63+MN+OF	400	44393	DS1 630/630+MN	400	44431
DS1 125/63+MN+OF	230	44394	DS1 630/630+MN	230	44432
DS1 125/80+MN	400	44395	DS1 630/630+MN+OF	400	44433
DS1 125/80+MN	230	44396	DS1 630/630+MN+OF	230	44434
DS1 125/80+MN+OF	400	44397	DS1 800/800+MN	400	44435
DS1 125/80+MN+OF	230	44398	DS1 800/800+MN	230	44436
DS1 125/100+MN	400	44399	DS1 800/800+MN+OF	400	44437
DS1 125/100+MN	230	44402	DS1 800/800+MN+OF	230	44438
DS1 125/100+MN+OF	400	44405	DS1 1250/1000+MN	400	44439
DS1 125/100+MN+OF	230	44406	DS1 1250/1000+MN	230	44440
DS1 125/125+MN	400	44407	DS1 1250/1000+MN+OF	400	44441
DS1 125/125+MN	230	44408	DS1 1250/1000+MN+OF	230	44442
DS1 125/125+MN+OF	400	44409	DS1 1250/1250+MN	400	44443
DS1 125/125+MN+OF	230	44410	DS1 1250/1250+MN	230	44444
DS1 160/100+MN	400	44475	DS1 1250/1250+MN+OF	400	44445
DS1 160/100+MN	230	44476	DS1 1250/1250+MN+OF	230	44446
DS1 160/100+MN+OF	400	44477	DS1 1600/1600+MN	400	44447
DS1 160/100+MN+OF	230	44478	DS1 1600/1600+MN	230	44448
DS1 160/160+MN	400	44411	DS1 1600/1600+MN+OF	400	44449
DS1 160/160+MN	230	44412	DS1 1600/1600+MN+OF	230	44450
DS1 160/160+MN+OF	400	44413	DS1 400/3300+MN	400	44483
DS1 160/160+MN+OF	230	44414	DS1 400/3300+MN	230	44484
DS1 250/200+MN	400	44415	DS1 400/3300+MN+OF	400	44485
DS1 250/200+MN	230	44416	DS1 400/3300+MN+OF	230	44486
DS1 250/200+MN+OF	400	44417	DS1 630/3300+MN	400	44487
DS1 250/200+MN+OF	230	44418	DS1 630/3300+MN	230	44488
DS1 250/250+MN	400	44419	DS1 630/3300+MN+OF	400	44489
DS1 250/250+MN	230	44420	DS1 630/3300+MN+OF	230	44490
DS1 250/250+MN+OF	400	44421	DS1 800/3300+MN	400	44491
DS1 250/250+MN+OF	230	44422	DS1 800/3300+MN	230	44492
DS1 400/315+MN	400	44479	DS1 800/3300+MN+OF	400	44493
DS1 400/315+MN	230	44480	DS1 800/3300+MN+OF	230	44494

EXTERNAL DEVICES

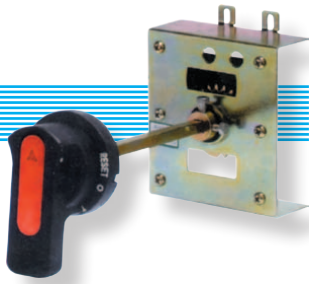

Remote control (manual)

Description:

The device switches off/on the breaker to which manual operative rotary mechanism is mounted - two operating positions of the executive mechanism fixed at 90°C

Mounting:

The base is mounted with bolts right on the cover (scheme 1 mounting), and the handle is mounted at the door of the distribution box, using an extension axis it is joined to the base

Table with the dimensions for manual remote control

Type of the breaker	Dimensions (mm)				
	A	B	C	Dmin	Dmax
HDC DS 1 125A	25	50	50	65	115
HDC DS 1 160A	30	50	50	65	115
HDC DS 1 250A	35	70	70	80	130
HDC DS 1 400A	45	107	107	85	105
HDC DS 1 630A	70	119	119	110	110
HDC DS 1 800A	70	119	119	110	110

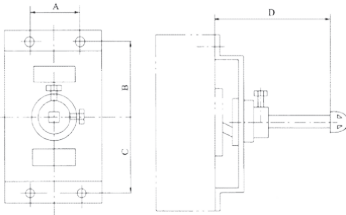
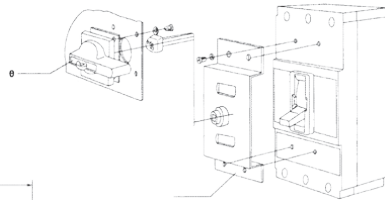

scheme 1

Type	Type of the breaker	Packing/Box (pcs)	Catalogue number
HDC	DS1 125A	1	44967
HDC	DS1 160A	1	44968
HDC	DS1 250A	1	44969
HDC	DS1 400A	1	44970
HDC	DS1 630A	1	44971
HDC	DS1 800A	1	44972



DS1 - 125-160

Device for remote control (electrical)

Description:

The device switches off/on the breaker to which it is mounted, at electrical signal it allows control from a great distance

Technical data:

- operating voltage of the executive mechanism: 230/400V 50/60Hz
- two operating positions of the executive mechanism fixed at 90°C
- two types of executive mechanism:
- * magnetic operation for breakers DS1 up to 160A
- * motor operation for breakers DS1 from 250 to 800A

Mounting:

The base is mounted with bolts right on the cover (scheme 1 and 2), and buttons on/off are fixed at the door of the distribution box and at the remote control device



DS1 - 250-1600

Type	Type of the breaker	Operating voltage	Packing/Box (pcs)	Catalogue number
ADC	DS1 125	400V	1	44907
ADC	DS1 160	400V	1	44908
ADC	DS1 250	400V	1	44909
ADC	DS1 400	400V	1	44910
ADC	DS1 630	400V	1	44911
ADC	DS1 800	400V	1	44911
ADC	DS1 125	230V	1	44912
ADC	DS1 160	230V	1	44913
ADC	DS1 250	230V	1	44914
ADC	DS1 400	230V	1	44915
ADC	DS1 630	230V	1	44916
ADC	DS1 800	230V	1	44916
ADC	DS1 1600	230V	1	44924
ADC	DS1 1600	400V	1	44926

Table with the dimensions for remote control

Type of the breaker	Dimensions (mm)				
	A	A1	B	B1	H
ADC DS 1 125	103.5	110	30	90	92
ADC DS 1 160	103.5	110	35	90	92
ADC DS 1 250	139	-	132	-	105
ADC DS 1 400	226	-	132	-	132
ADC DS 1 630	226	-	132	-	132
ADC DS 1 800	226	-	132	-	132

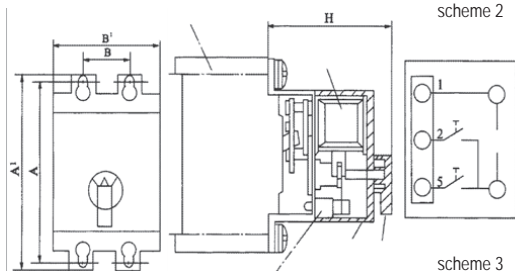

scheme 2

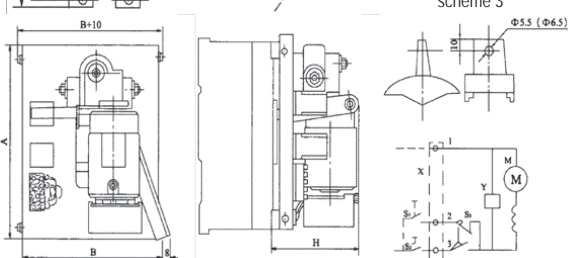

scheme 3



Documents corresponding to the product:
 Standard EN 60947-1; EN 60947-2;
 IEC 947-2

The DW1 series is an intelligent type circuit breaker used to control and protect low voltage electrical distribution network. Possibility to set the parameters of the circuit protection, built in under voltage release, remote control, earth protection and load monitoring.

Functions:

- switching on/off heavy loaded electrical circuits
- breaking of electrical circuits and control of powerful consumers
- used as a main breaker in housing or industrial distributing installations
- endures high currents of short circuit in the protected circuit
- remarkable with high reliability of current characteristics
- motor control
- mounted auxiliary devices for automation - under voltage release, earth protection, intelligent controlling block with a possibility for a choice of the protected function

Technical data:

- * Rated operating voltage: 690V; 50/60Hz
- * Isolating voltage: 2000V
- * Surge voltage wear resistance: $\geq 8000V$
- * Joining terminal: bolt connection with 4 bolts to the power supply rail
- * Connecting:
 - copper rails
 - busway connection – at the back
- * Electrical wear resistance (number of cycles): ≥ 500
- * Mechanical wear resistance (number of cycles): ≥ 9000
- * IP code: IP54
- * Mounting:
 - clamping with bolts
 - mounting position: vertical gradient – maximum 5°
- * Plastic material of UV rays and non-flammable
- * Test button
- * Ambient temperature: -10°C + 45°C
- * Installation altitude: up to 2000m

Basic protective functions:

- * Overload protection with long time delay
- * Short circuit protection with short time delay, time inversion limit
- * Short circuit protection with short time delay, time fixed limit
- * Instantaneous short circuit protection
- * Earth protection function
- * Full stability function
- * "Overload alarm" function
- * Test function
- * Auto diagnostics function

A commutation type of breakers with RS 485 connection for duplex transmission of all function parameters, adjustment and data can also be produced at client's order and delivery terms agreement.

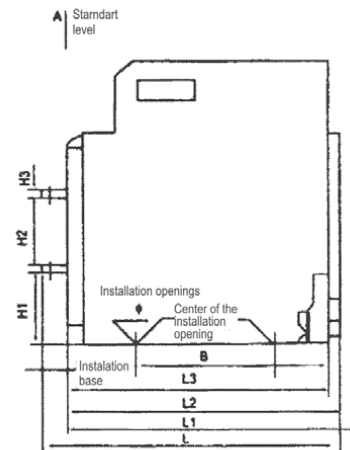
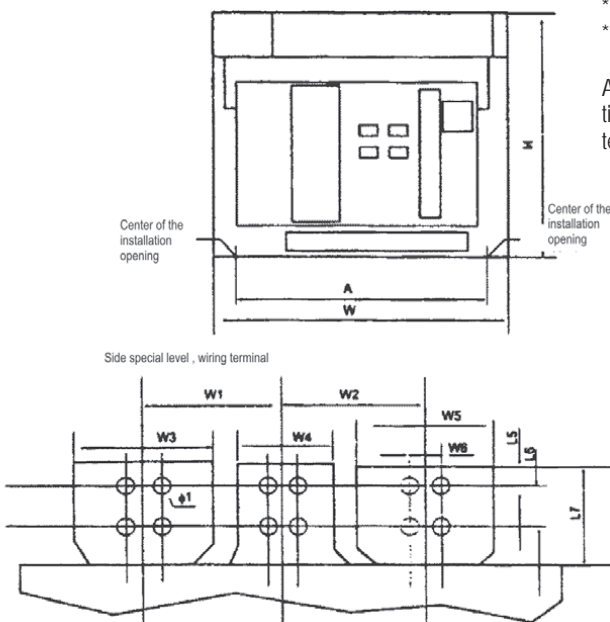

Type	Outside dimensions															
	A	H	W	B	L	L1	H1	H2	H3	W1/W2	L5	L6	L7	W3-W5	Ø	
DW1 2000A	340	402	362	150	373	290	52	112	20	95	17	40	82	60	12	
DW1 3200A	352	432	435	175	507	448	92	112	30	115	17	40	82	100	12	

Connecting scheme

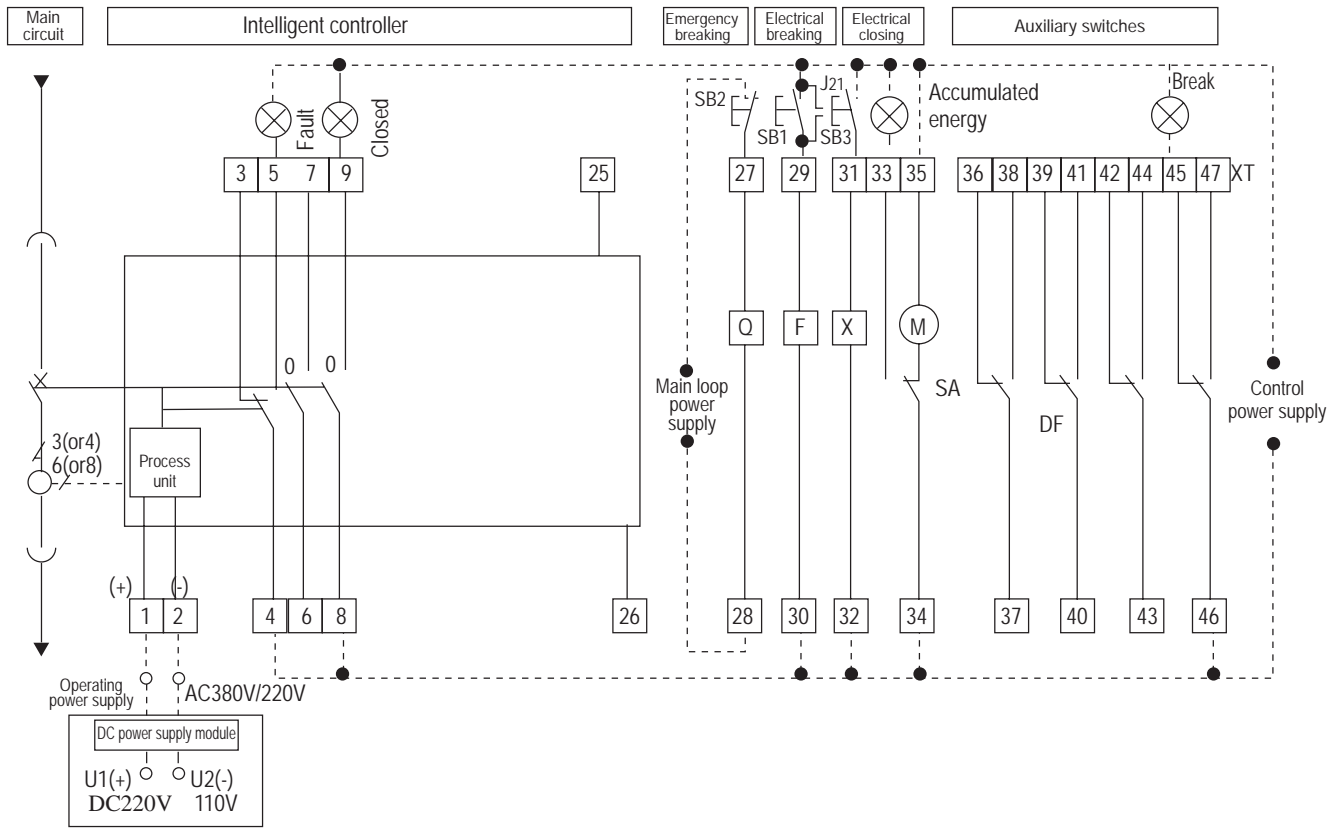

Type	Rated current In (A)	Rated voltage Un (V)	Breaking capacity (kA)	Electrical wear resistance (number of cycles)	Mechanical wear resistance (number of cycles)	Packing/Box (pcs)	Catalogue number
DW1 - 2000	2000	690	80	500	9500	1 / 1	44209
DW1 - 3200	2500	690	100	500	9500	1 / 1	44255
DW1 - 3200	3200	690	100	500	9500	1 / 1	44329

Documents corresponding
to the product:
EN 60947-1
EN 60947-2; EN 60947-6-1



The system for dual power change-over switch EQ1 is designed to provide continuous power supply and two electrical sources automatic switch in case of failure or deviation from the set parameters.

The system for dual power change-over switch consists of two high capacity circuit breakers mounted on a metal frame connected with common operating mechanism and controlled by a command device that controls the system parameters' correspondence.

Functions:

- * Switching on/off heavy loaded electrical circuits at main power supply discrepancy
- * Switching to dual power change-over at power supply phase lack
- * Breaking of electrical circuits and control of powerful consumers
- * Used as a main breaker in housing or industrial distributing installations supplied with a generator or a second power supply source (hospitals, post offices, military sites, control rooms)
- * Remarkable with high reliability of current characteristics
- * Control: motor
- * Controls the following circuit parameters:
 - presence of the three phases
 - the phase voltage to be in the set limits
 - overload
 - short circuit at the outlet

Technical data:

- * Rated operating voltage: 690V; 50/60Hz
- * Surge voltage wear resistance: $\geq 6000V$
- * Joining terminal: bolt connection with 4 bolts to the power supply rail
- * Connecting:
 - copper rails
 - flexible or rigid conductors
- * Electrical wear resistance (number of cycles): ≥ 60000
- * Mechanical wear resistance (number of cycles): ≥ 10000
- * IP code: IP21
- * Mounting:
 - clamping with bolts
 - mounting position: vertical gradient – maximum 5°
- * Plastic material of the breakers of UV rays and non-flammable
- * Ambient temperature: $-10^\circ C + 45^\circ C$
- * Installation altitude: up to 2000m

Basic functions of the control device:

- * Overload protection
- * Instantaneous short circuit protection
- * Under phase protection
- * Undervoltage protection
- * Possibility for setting the change-over time between the two sources – min 3s
- * Possibility for automatic switch-over to the main power supply source after restoring its parameters

The system for dual power change-over switch is offered in two types:

- with display (control device) mounted on the mounting plate (integrated type)
- with separated control display

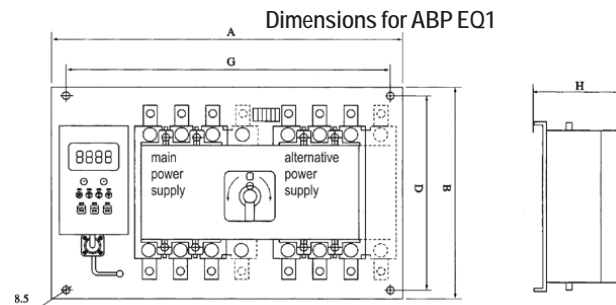

Type of the breaker	Type	Overall dimensions (mm)				
		A	B	C	D	H
EQ1 - 100	inner type	480	240	450	210	140
EQ1 - 225	inner type	480	240	450	210	140
EQ1 - 400	inner type	620	300	590	270	235
EQ1 - 630	inner type	660	300	630	270	240
EQ1 - 100*	moved type	420	230	390	200	145
EQ1 - 225*	moved type	420	230	390	200	145
EQ1 - 400*	moved type	570	300	540	270	235
EQ1 - 630*	moved type	610	300	580	270	240

Type	Rated current In (A)	Max. breaking capacity (kA) Icu	Operating breaking capacity (kA) Ics	Section of the power supply conductor (mm ²)	Electrical wear resistance (number of cycles)	Packing/Box (pcs)	Catalogue number
EQ1 - 100	100	22	15	35	6000	1 / 1	44100
EQ1 - 225	225	35	25	70	6000	1 / 1	44225
EQ1 - 400	400	42	35	180	6000	1 / 1	44403
EQ1 - 630	630	50	42	240	6000	1 / 1	44633
EQ1 - 100*	100	22	15	35	6000	1 / 1	44101
EQ1 - 225*	225	35	25	70	6000	1 / 1	44226
EQ1 - 400*	400	42	35	180	6000	1 / 1	44404
EQ1 - 630*	630	50	42	240	6000	1 / 1	44634

Note: *Dual power change-over switch with separated control display

INDIRECT PROTECTION DEVICES

INDIRECT PROTECTION

EL[®]MARK

RT N DEVICES



INDIRECT PROTECTION DEVICES



COVER ①

TERMINALS ②

NON-FLAMABLE BASE ③

CONTACT ④

TEST BUTTON ⑤

SECONDARY WINDING OF TT ⑥

PRIMARY WINDING ⑦

SUMMING CURRENT TRANSFORMER (TT) WITH TOROID ⑧

ELECTROMAGNETIC RELAY ⑨

BREAKING (RELEASE) UNIT ⑩

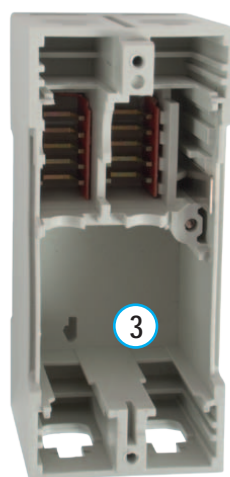
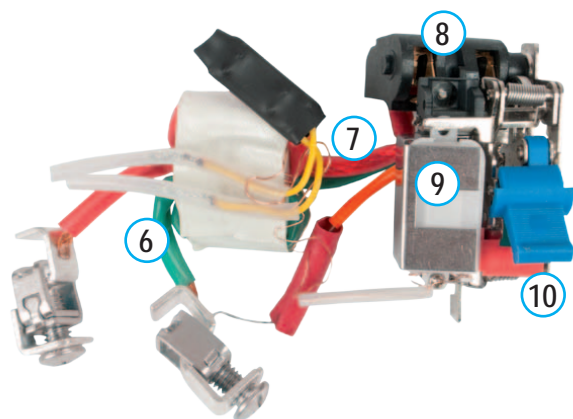
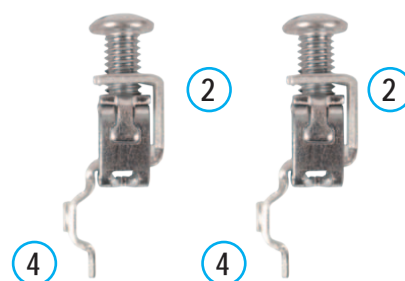
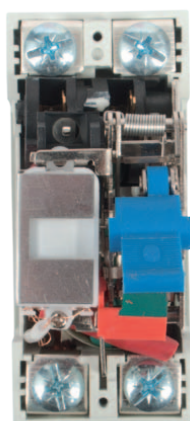
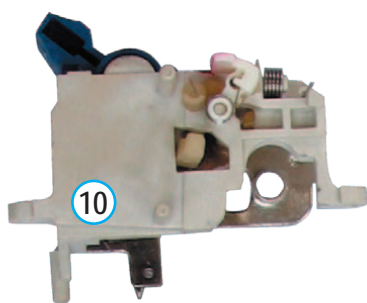



Type AC for AC current

Documents corresponding to the product:

- EN 61008-1
- EN 61008-2; EN 60947-1

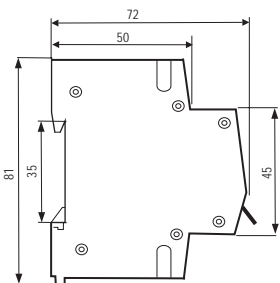
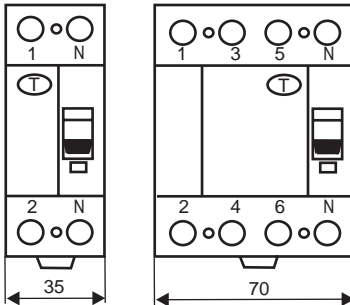

The residual current device works with no extra power supply to the operating mechanism. It compares the magnitude of the currents through the neutral and phase conductors. The conductors are coiled on toroid and together with the secondary winding form a measurement transformer. The power conductors are coiled in such a way that the magnetic fields generated at electrical current flow through them are mutually neutralized. At failure in the insulation of some of the conductors or at presence of a person under voltage, the system is misbalanced and the magnetic fields can not be neutralized. This residual field generates in the secondary current winding, called current leakage. The device breaks when the value of this current exceeds the limit value of the residual current breaker.

Functions:

- switching off heavy-loaded electrical circuits at insulation damage of the conductors to the consumers
- switching off heavy-loaded electrical circuits at presence of a person under voltage
- used to protect not only particular consumers/circuits, but also the whole panel
- remarkable with high reliability of current characteristics
- control: manual switching on and automatic switching off at exit failure

Technical data:

- * Rated operating voltage: 230/400V; 50/60 Hz
- * Rated current: according to the table
- * Responsiveness: 30; 100; 300; 500mA
- * Time delay until break: <0.1s at I Δ n and <0.04s at 2I Δ n
- * Surge voltage wear resistance: ≥2000V
- * Short circuit current wear resistance: 4500A, 6000A
- * Joining terminal: flat (tunnel) screw terminal made of 1.5 coldly draw-plated plane Q235A
- * Type of the plastic:
 - material: self-extinguishing nylon PA66
 - permittivity strength: >18MV/m
- * Contact head: silver graphite CAg(5)
- * Static contact: pure copper T2Y2 type
- * Electrical wear resistance (number of cycles): ≥5000
- * Mechanical wear resistance (number of cycles): ≥10000
- * IP code: IP>20
- * Indication for operating (switched on) position
- * Plastic material of the breakers of UV rays and non-flammable
- * Ambient temperature: -10°C + 45°C
- * Installation altitude: up to 2000m

Connecting:

- power supply busbar (only for bipolar)
- flexible or rigid conductors with corresponding section

Mounting:

- on DIN-rail
- mounting position: vertical

The residual current device is mounted in the distribution box, and after the device the neutral conductor and the earthing conductor must not be connected together. In order to work accurately, the device must have three- or five-conductor grid with separate protective conductor (PE) (e.g. earthing system TN-S or TT with three or five conductors). The corpus of the consumer depending on the grid type must be connected either to the protective conductor or be earthed. (Fig.1)

Fig. 1

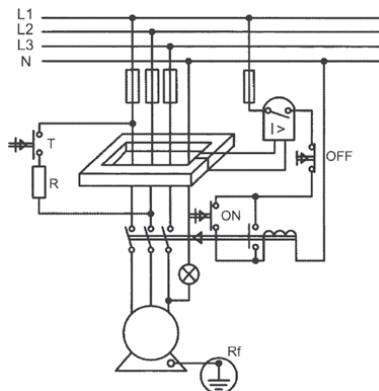

Connecting scheme

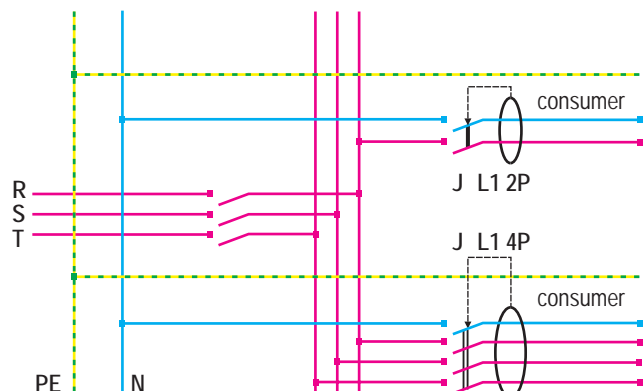



Type A for AC/DC current

Documents corresponding to the product:
EN 61008-1
EN 61008-2; EN 60947-1

Residual current protection type A - JEL 1A.

These are Residual Current Devices (RCDs) JEL 1A with enhanced sensibility and fast - operating protection devices applicable in circuits with harmonic or direct pulsating current component presence.

Functions:

- * switching off electrical circuits on load at conductor insulation breaking to the consumer
- * switching off electrical circuits on load at direct and indirect contact
- * switching off electrical circuits on load at alternating earth fault currents during consequent light impact
- * switching off consumers at harmonic presence due to luminescent lights
- * switching off consumers in DC circuits at fault currents presence
- * mechanical indicator for ON position

Technical data:

- * Rated operating voltage: 230/400V; 50 Hz
- * Rated current: according to the table
- * Responsiveness: 30; 100; 300; 500mA
- * Time delay until break: <0.1s at I Δ n and <0.04s at 2I Δ n
- * Short circuit current wear resistance: 6000A
- * Electrical wear resistance (number of cycles): ≥5000
- * Mechanical wear resistance (number of cycles): ≥10000
- * IP code: IP>20

Connecting:

- power supply busbar (only for bipolar)
- flexible or rigid conductors with corresponding section

Mounting:

- on DIN-rail
- mounting position: vertical

Residual current devices JEL2, 4,5kA - Type AC - alternating fault current. Impulse withstand voltage 2000VAC



Type	Number of poles	Breaking capacity (kA)	Rated current In (A)	Packing/Box (pcs)	Catalogue number			
					Leakage current I Δ n (mA)			
					30	100	300	500
JEL 2	2	4.5	10.0	1 / 60	40710	40712	40713	40714
JEL 2	2	4.5	16.0	1 / 60	40716	40717	40718	40719
JEL 2	2	4.5	20.0	1 / 60	40792	40793	40794	40795
JEL 2	2	4.5	25.0	1 / 60	40721	40722	40723	40724
JEL 2	2	4.5	32.0	1 / 60	40731	40732	40733	40734
JEL 2	2	4.5	40.0	1 / 60	40741	40742	40743	40744
JEL 2	2	4.5	63.0	1 / 60	40761	40762	40763	40764



Type	Number of poles	Breaking capacity (kA)	Rated current In (A)	Packing/Box (pcs)	Catalogue number			
					Leakage current I Δ n (mA)			
					30	100	300	500
JEL 2	4	4.5	10.0	1/30	40810	40812	40813	40814
JEL 2	4	4.5	16.0	1/30	40816	40817	40818	40819
JEL 2	4	4.5	20.0	1/30	40892	40893	40894	40895
JEL 2	4	4.5	25.0	1/30	40821	40822	40823	40824
JEL 2	4	4.5	32.0	1/30	40831	40832	40833	40834
JEL 2	4	4.5	40.0	1/30	40841	40842	40843	40844
JEL 2	4	4.5	63.0	1/30	40861	40862	40863	40864

Residual current devices JEL 1, 6kA - Type AC - alternating fault currents sensible. Impulse withstand voltage 2000VAC



Type	Number of poles	Breaking capacity (kA)	Rated current In (A)	Packing/Box (pcs)	Catalogue number			
					Leakage current I Δ n (mA)			
					30	100	300	500
JEL 1	2	6	10.0	1 / 60	40210	40212	40213	40214
JEL 1	2	6	16.0	1 / 60	40216	40217	40218	40219
JEL 1	2	6	20.0	1 / 60	40292	40293	40294	40295
JEL 1	2	6	25.0	1 / 60	40221	40222	40223	40224
JEL 1	2	6	32.0	1 / 60	40231	40232	40233	40234
JEL 1	2	6	40.0	1 / 60	40241	40242	40243	40244
JEL 1	2	6	63.0	1 / 60	40261	40262	40263	40264
JEL 1	2	6	80.0	1 / 60	40281	40282	40283	40284
JEL 1	2	6	100.0	1 / 60	40291	40296	40297	40298



Type	Number of poles	Breaking capacity (kA)	Rated current In (A)	Packing/Box (pcs)	Catalogue number			
					Leakage current I Δ n (mA)			
					30	100	300	500
JEL 1	4	6	10.0	1 / 30	40410	40412	40413	40414
JEL 1	4	6	16.0	1 / 30	40416	40417	40418	40419
JEL 1	4	6	20.0	1 / 30	40492	40493	40494	40495
JEL 1	4	6	25.0	1 / 30	40421	40422	40423	40424
JEL 1	4	6	32.0	1 / 30	40431	40432	40433	40434
JEL 1	4	6	40.0	1 / 30	40441	40442	40443	40444
JEL 1	4	6	63.0	1 / 30	40461	40462	40463	40464
JEL 1	4	6	80.0	1 / 30	40481	40482	40483	40484
JEL 1	4	6	100.0	1 / 30	40491	40496	40497	40498

Residual current devices JEL 1A, 6kA - Type A - alternating and pulsating direct fault currents sensible. Impulse withstand voltage 2000VAC/ 400VDC



Type	Number of poles	Breaking capacity (kA)	Rated current In (A)	Packing/Box (pcs)	Catalogue number			
					Leakage current I Δ n (mA)			
					30	100	300	500
JEL 1A	2	6	10.0	1 / 60	40510	40512	40513	40514
JEL 1A	2	6	16.0	1 / 60	40516	40517	40518	40519
JEL 1A	2	6	20.0	1 / 60	40592	40593	40594	40595
JEL 1A	2	6	25.0	1 / 60	40521	40522	40523	40524
JEL 1A	2	6	32.0	1 / 60	40531	40532	40533	40534
JEL 1A	2	6	40.0	1 / 60	40541	40542	40543	40544
JEL 1A	2	6	63.0	1 / 60	40561	40562	40563	40564
JEL 1A	2	6	80.0	1 / 60	40581	40582	40583	40584
JEL 1A	2	6	100.0	1 / 60	40591	40596	40597	40598



Type	Number of poles	Breaking capacity (kA)	Rated current In (A)	Packing/Box (pcs)	Catalogue number			
					Leakage current I Δ n (mA)			
					30	100	300	500
JEL 1A	4	6	10.0	1 / 30	40610	40612	40613	40614
JEL 1A	4	6	16.0	1 / 30	40616	40617	40618	40619
JEL 1A	4	6	20.0	1 / 30	40692	40693	40694	40695
JEL 1A	4	6	25.0	1 / 30	40621	40622	40623	40624
JEL 1A	4	6	32.0	1 / 30	40631	40632	40633	40634
JEL 1A	4	6	40.0	1 / 30	40641	40642	40643	40644
JEL 1A	4	6	63.0	1 / 30	40661	40662	40663	40664
JEL 1A	4	6	80.0	1 / 30	40681	40682	40683	40684
JEL 1A	4	6	100.0	1 / 30	40691	40696	40697	40698

Documents corresponding to the product:
EN 61 009-1; EN 61009-2;

Description of the operating system:

It is a combination of automatic circuit breaker and residual current electromagnetic device. It combines the properties of the two elements. The circuit breaker reacts at short circuit or overload in the protected circuit, and the electromagnetic residual current device - at failure in the conductors' insulation. It compares the magnitude of the currents through the neutral and phase conductors. The conductors are coiled on toroid and together with the secondary winding form a measurement transformer. The power conductors are coiled in such a way that the magnetic fields generated at electrical current flow through them are mutually neutralized. At failure in the insulation of some of the conductors or at presence of a person under voltage, the system is misbalanced and the magnetic fields can not be neutralized. This residual magnetic field generates in the secondary current winding, called current leakage. When the value of this current exceeds the limit value of the residual current breaker the device breaks and the residual current device switches off from the power supply grid. The device operates without any extra power supply to the electromagnetic residual current and is not influenced by voltage varying or decreasing.

Functions:

- switching off heavy-loaded electrical circuits at short circuit or overload
- switching off heavy-loaded electrical circuits at insulation damage of the conductors to the consumers
- switching off heavy-loaded electrical circuits at presence of a person under voltage
- used to protect not only particular consumers/circuits, but also the whole panel
- remarkable with high reliability of current characteristics
- control: manual switching on and automatic switching off at failure in the insulation after the breaker

Technical data:

- * Rated operating voltage: 230V 50 Hz
- * Circuit breaker rated current: according to the table
- * Residual current responsiveness: 30; 100; 300; 500mA
- * Time delay until break:
 - of the residual current device: <0.1s at I Δ n and <0.04s at 2I Δ n
 - of the circuit breaker: <0.1s
- * Circuit breaker breaking curve: C
- * Surge voltage wear resistance: ≥2000V
- * Breaking capacity: 10000
- * Joining terminal: flat (tunnel) screw terminal made of 1.5 coldly draw-plated plane Q235A
- * Type of the plastic:
 - material: self-extinguishing nylon PA66
 - dielectrical strength: >18MV/m
- * Contact head: silver graphite CAg(5)
- * Static contact: pure copper T2Y2 type
- * Electrical wear resistance (number of cycles): ≥5000
- * Mechanical wear resistance (number of cycles): ≥10000
- * IP code: IP>20
- * Indication for operating (switched on) position
- * Breakers plastic material of UV rays and non-flammable
- * Ambient temperature: -10°C + 45°C
- * Installation altitude: up to 2000m

Connecting:

- flexible or rigid conductors with corresponding section

Mounting:

- on DIN-rail
- mounting position: vertical

The residual current device is mounted in the distribution box, and after the device the neutral conductor and the earthing conductor must not be connected together. In order to work accurately, the device must have three- or five-conductor grid with separate operating neutral conductor (N) and separate protecting conductor (PE) (e.g. earthing system TN-S or TT with three or five conductors).



Combined electromagnetic residual current device and circuit breaker 1P 10kA

Type designation	Number of poles	Breaking capacity (kA)	Sections of the mounting conductors (mm ²)	Rated current (A)	Packing / Box (pcs)	Catalogue number			
						Leakage current I Δ n (mA)			
						30	100	300	500
JEL5	2	10	1.5	10	7 / 140	40010	40011	40013	40015
JEL5	2	10	2.5	16	7 / 140	40016	40017	40018	40019
JEL5	2	10	4.0	25	7 / 140	40025	40021	40023	40026
JEL5	2	10	6.0	32	7 / 140	40032	40031	40033	40035
JEL5	2	10	10.0	40	7 / 140	40040	40041	40043	40045

Documents corresponding to the product:
EN 61 009-1; EN 61009-2;

Description of the operating system:

It is a combination of automatic circuit breaker and residual current electromagnetic device. It combines part of the properties of the two elements. The circuit breaker reacts at short circuit in the protected circuit, and the electromagnetic residual current device - at failure in the conductors' insulation. It compares the rate of the currents through the conductors in an electronic comparator. The residual current device operates normally at voltage feed. The voltage is needed for the comparator's energizing – a semi-conductor element with constantly set leakage current rate. This rate is compared with the actual rate. When the margin of the comparison is neutral, the residual current device does not operate, but at failure in the protected circuit insulation when it exceeds the set margin it operates and switches off the protection. For the normal operation of the residual current device, the power supplying circuit voltage must be over 170V and there must be no time variation.

Functions:

- switching off heavy-loaded electrical circuits at short circuit or overload
- switching off heavy-loaded electrical circuits at insulation damage of the conductors to the consumers
- switching off heavy-loaded electrical circuits at presence of a under voltage
- used to protect not only particular consumers/circuits, but also the whole panel
- remarkable with high reliability of current characteristics
- control: manual switching on and automatic switching off at exit failure

Technical data:

- * Rated operating voltage: 230/400V 50 Hz
- * Circuit breaker rated current: according to the table
- * Residual current responsiveness: 30; 100; 300; 500mA
- * Time delay until break:
 - of the residual current device: <0.1s at I Δ n and <0.04s at 2I Δ n
 - of the circuit breaker: <0.1s
- * Circuit breaker breaking curve: C
- * Surge voltage wear resistance: ≥2000V
- * Breaking capacity: 4500A; 6000A
- * Joining terminal: flat (tunnel) screw terminal
- * Electrical wear resistance (number of cycles): ≥500
- * Mechanical wear resistance (number of cycles): ≥2000
- * IP code: IP>20
- * Indication for operating (switched on) position

Connecting:

- power supply busbar (for two- or three polar)
- flexible or rigid conductors with corresponding section

Mounting:

- on DIN-rail
- mounting position: vertical
- * Breakers plastic material of UV rays and non-flammable
- * Ambient temperature: -10°C + 45°C
- * Installation altitude: up to 2000m

The residual current device is mounted in the distribution box, and after the device the neutral conductor and the earthing conductor must not be connected together. In order to work accurately, the device must have separate conductors for operational neutral conductor (N) and protective conductor (e.g. earthing system TN-S or TT with three or five conductors).

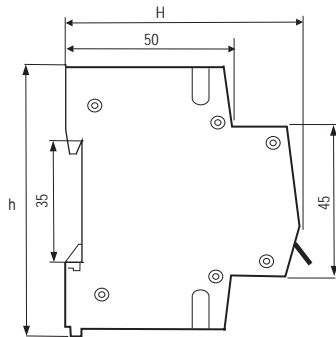
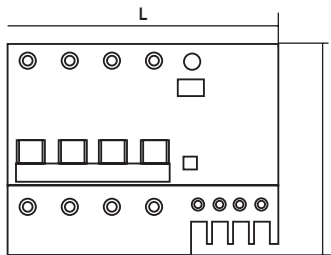

Type	Overall dimensions (mm)		
	L	H	h
JEL 3	18	72	80
JEL 4	35	72	80
3P	88	95	
3P+N	115.5	95	

Combined electronic residual current device with circuit breaker 1P, 6kA

Type designation	Number of poles	Breaking capacity (kA)	Sections of the mounting conductors (mm ²)	Rated current (A)	Packing / Box (pcs)	Catalogue number Leakage current I Δ n (mA)			
						30	100	300	500
JEL 4 C10	2	6	1.5	10	5 / 100	40211E	40207E	40208E	40209E
JEL 4 C16	2	6	2.5	16	5 / 100	40215E	40245E	40235E	40237E
JEL 4 C20	2	6	4.0	20	5 / 100	40225E	40229E	40230E	40238E
JEL 4 C25	2	6	4.0	25	5 / 100	40240E	40204E	40246E	40268E
JEL 4 C32	2	6	10.0	32	5 / 100	40265E	40260E	40236E	40269E
JEL 4 C40	2	6	16.0	40	5 / 100	40274E	40270E	40273E	40275E



Combined electronic residual current device 1P + N.

Compares the leakage current between the phase and neutral conductors.



Type designation	Number of poles	Breaking capacity (kA)	Sections of the mounting conductors (mm ²)	Rated current (A)	Packing/Box (pcs)	Catalogue number			
						Leakage current I _{Δn} (mA)			
						30	100	300	500
JEL 6 C10	2	4.5	1.5	10	12 / 240	40110	40111	40113	40114
JEL 6 C16	2	4.5	2.5	16	12 / 240	40116	40117	40118	40119
JEL 6 C25	2	4.5	4.0	25	12 / 240	40125	40121	40123	40126
JEL 6 C40	2	4.5	10.0	40	12 / 240	40140	40141	40133	40145
JEL 6 C50	2	4.5	16.0	50	12 / 240	40163	40161	40136	40165

Combined electronic residual current device 2P.

Compares the leakage current between the phase and neutral conductors or between two phases.

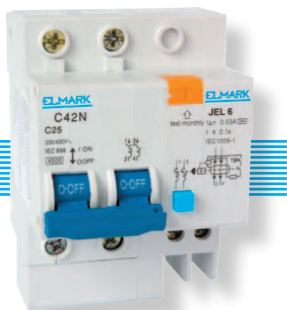

Type designation	Number of poles	Breaking capacity (kA)	Sections of the mounting conductors (mm ²)	Rated current (A)	Packing/Box (pcs)	Catalogue number			
						Leakage current I _{Δn} (mA)			
						30	100	300	500
JEL 6 C10	2	4.5	1.5	10	6 / 120	40211	40207	40208	40209
JEL 6 C16	2	4.5	2.5	16	6 / 120	40215	40245	40235	40237
JEL 6 C25	2	4.5	4.0	25	6 / 120	40225	40229	40230	40238
JEL 6 C40	2	4.5	10.0	40	6 / 120	40240	40204	40246	40268
JEL 6 C50	2	4.5	16.0	50	6 / 120	40265	40260	40236	40269

Combined electronic residual current device 3P.

Compares the leakage current between the phases.



Type designation	Number of poles	Breaking capacity (kA)	Sections of the mounting conductors (mm ²)	Rated current (A)	Packing/Box (pcs)	Catalogue number			
						Leakage current I _{Δn} (mA)			
						30	100	300	500
JEL 6 C10	3	4.5	1.5	10	3 / 60	40310	40311	40313	40314
JEL 6 C16	3	4.5	2.5	16	3 / 60	40316	40317	40318	40319
JEL 6 C25	3	4.5	4.0	25	3 / 60	40325	40321	40323	40324
JEL 6 C40	3	4.5	10.0	40	3 / 60	40340	40341	40343	40344
JEL 6 C50	3	4.5	16.0	50	3 / 60	40363	40361	40336	40365

Combined electronic residual current device 3P+N.

Compares the leakage current between the three phases and neutral conductors.

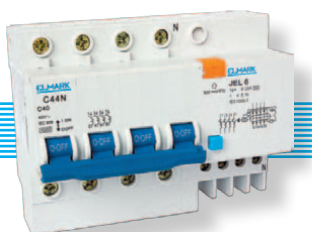

Type designation	Number of poles	Breaking capacity (kA)	Sections of the mounting conductors (mm ²)	Rated current (A)	Packing/Box (pcs)	Catalogue number			
						Leakage current I _{Δn} (mA)			
						30	100	300	500
JEL 6 C10	4	4.5	1.5	10	2 / 40	40411	40407	40408	40409
JEL 6 C16	4	4.5	2.5	16	2 / 40	40415	40445	40439	40438
JEL 6 C25	4	4.5	4.0	25	2 / 40	40425	40420	40428	40429
JEL 6 C40	4	4.5	10.0	40	2 / 40	40440	40404	40447	40446
JEL 6 C50	4	4.5	16.0	50	2 / 40	40465	40401	40436	40469



Documents corresponding to the product:
Standard EN61 643-1 EN 61 643-1

The breakers are in accordance with the directives of EC "Low voltage directives (LVD) no. 73/23 EEC" and "Electromagnetic Compatibility Directives (EMC) no. 89/336 EEC".

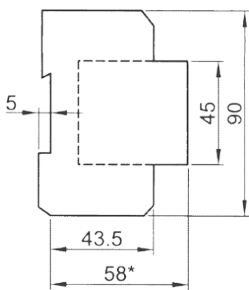

The surge arrester consists of a semi-conductor valve element that opens at certain conditions. At normal conditions of the system, the surge arrester has infinitely high resistance between the protected conductors and earthing circuit. At voltage increase due to atmospheric nature or system failure, the valve element opens and leads the excessive voltage to the grounded circuit.

After reversion of the normal voltage the valve element closes. The arrester can endure high momentary overloading.

Functions:

- protection of heavy-loaded electrical circuits from overload
- used to protect not only particular consumers/circuits, but also the whole panel
- remarkable with high reliability of current characteristics
- control: automatic switching off at exit failure and recovery after eliminating the danger

Technical data:

- * Rated operating voltage U_c : - the operating voltage of the surge arrester 275/440V; 50Hz
- * Surge voltage U_p : the voltage created in surge arrester terminals at rated discharge current running: according to the tables
- * Rated discharge current I_n – the rated value of discharge current with a sinusoid 8/20 μ s, which can be repeatedly led to the ground: according to the tables
- * Full discharge current I_{max} – the peak value of the discharge current with a sinusoid 8/20 μ s, which the surge arrester can bear once: according to the table
- * Constant operating current: up to 800 μ A for 1P, 2P and 3P; up to 600 μ A for 1P + N, 3P + N
- * Indication for damaged surge arrester
- * Offered in types: 1P; 1P + N; 3P; 3P + N

Connecting:

- * flexible or rigid conductors with corresponding section

Mounting:

- * on DIN-rail
- * mounting position: vertical
- * mounting in the distribution box on the front or right before the breaker according to the attached schemes
- * Breakers plastic material of UV rays and non-flammable
- * Ambient temperature: -10°C + 45°C
- * Installation altitude: up to 2000m

COLOUR CODE for all types 5kA - yellow; white – 10kA; green – 20 kA and red 40kA

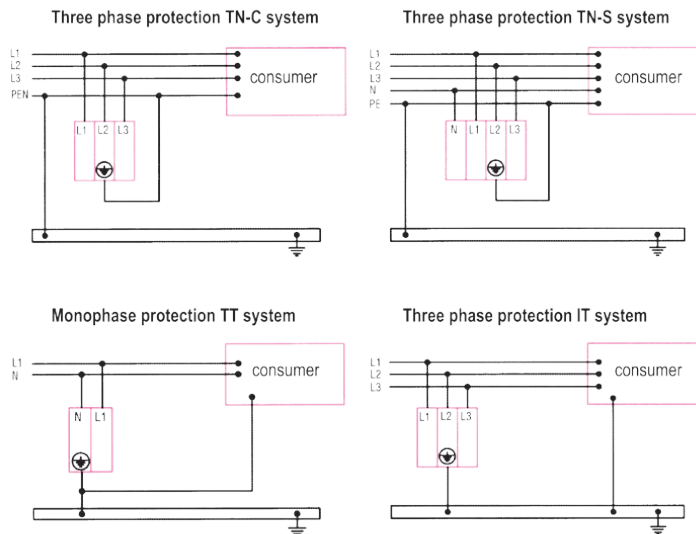

The surge arrester selection is made according to the overload risk level or atmosphere activity, named B, C or D (from high to low risk level).

The company offers the following models of arresters:

Model SPD – Bxxxx – for systems with exceptionally high risk level. Mounted mainly in the beginning of the installation or in the main panel.

Model SPD – Cxxxx – for systems with high or average risk level. Mounted in the beginning of the installation or before the breaker.

Model SPD – Dxxxx – for systems with low risk level. Suitable for secondary protection of consumers in combination with SPD – Bxxxx/SPD – Cxxxx



Type of the arrester	In (kA)	I _{max} (kA)	U _c (V)	U _p (kV)	Packing/Box (pcs)	Catalogue number
SPD-D5/1p	5	10	275	1.2	17 / 170	64101
SPD-C10/1p	10	20	275	1.2	17 / 170	64102
SPD-C20/1p	20	40	275	1.8	17 / 170	64103
SPD-B40/1p	40	60	275	2	17 / 170	64104



Type of the arrester	In (kA)	I _{max} (kA)	U _c (V)	U _p (kV)	Packing/Box (pcs)	Catalogue number
SPD-D5/1pN	5	10	275	1.2	8 / 80	64201
SPD-C10/1pN	10	20	275	1.2	8 / 80	64202
SPD-C20/1pN	20	40	275	1.8	8 / 80	64203
SPD-B40/1pN	40	60	275	2	8 / 80	64204



Type of the arrester	In (kA)	I _{max} (kA)	U _c (V)	U _p (kV)	Packing/Box (pcs)	Catalogue number
SPD-D5/3p	5	10	400	1.2	5 / 50	64301
SPD-C10/3p	10	20	400	1.2	5 / 50	64302
SPD-C20/3p	20	40	400	1.8	5 / 50	64303
SPD-B40/3p	40	60	400	2	5 / 50	64304

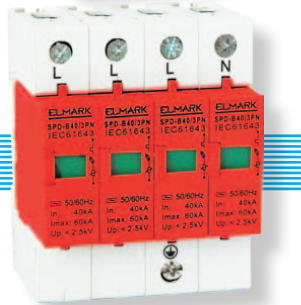

Type of the arrester	In (kA)	I _{max} (kA)	U _c (V)	U _p (kV)	Packing/Box (pcs)	Catalogue number
SPD-D5/3pN	5	10	400	1.2	4 / 40	64401
SPD-C10/3pN	10	20	400	1.2	4 / 40	64402
SPD-C20/3pN	20	40	400	1.8	4 / 40	64403
SPD-B40/3pN	40	60	400	2	4 / 40	64404

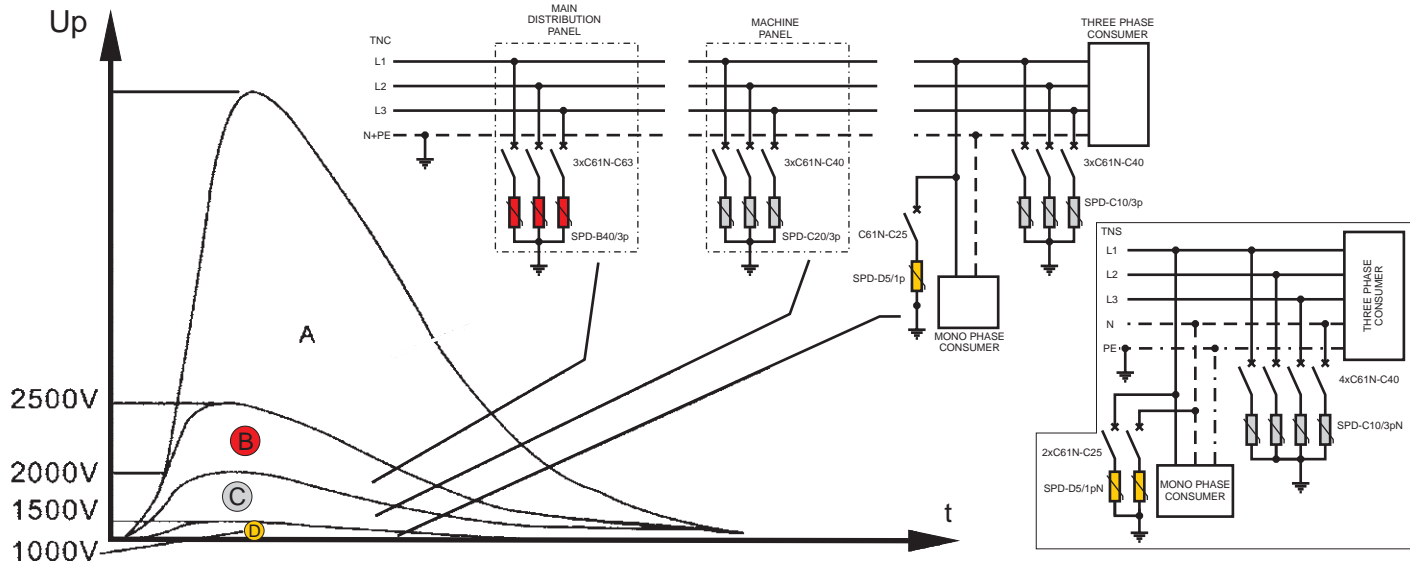

SURGE ARRESTERS combined AC – DC

Specially designed surge arresters providing protection of solar and photo - voltaic systems; designed to protect system against overvoltages resulting from indirect light impact. They could be installed in earthed and non - earthed systems. They break photo - voltaic generator electric circuit when voltage reaches or over passes limit threshold value, providing photo - voltaic protection against destroying.

COLOUR CODE for all types 5kA - yellow; white – 10kA; green – 20 kA and red 30kA



Type of the arrester	In (kA)	I _{max} (kA)	U _c (V)	U _p (kV)	Packing/Box (pcs)	Catalogue number
SPD-DC-D5/1p	5	10	275 AC/400 DC	≤ 1.2	17 / 170	64105
SPD-DC-C10/1p	10	20	275 AC/400 DC	≤ 1.5	17 / 170	64106
SPD-DC-C20/1p	20	40	275 AC/400 DC	≤ 1.8	17 / 170	64107
SPD-DC-B40/1p	30	60	275 AC/400 DC	≤ 2.2	17 / 170	64108



Type of the arrester	In (kA)	I _{max} (kA)	U _c (V)	U _p (kV)	Packing/Box (pcs)	Catalogue number
SPD-DC-D5/1pN	5	10	275 AC/400 DC	≤ 1.2	8 / 80	64205
SPD-DC-C10/1pN	10	20	275 AC/400 DC	≤ 1.5	8 / 80	64206
SPD-DC-C20/1pN	20	40	275 AC/400 DC	≤ 1.8	8 / 80	64207
SPD-DC-B40/1pN	30	60	275 AC/400 DC	≤ 2.2	8 / 80	64208



Type of the arrester	In (kA)	I _{max} (kA)	U _c (V)	U _p (kV)	Packing/Box (pcs)	Catalogue number
SPD-DC-D5/3p	5	10	385 AC/500 DC	≤ 1.2	5 / 50	64305
SPD-DC-C10/3p	10	20	385 AC/500 DC	≤ 1.5	5 / 50	64306
SPD-DC-C20/3p	20	40	385 AC/500 DC	≤ 1.8	5 / 50	64307
SPD-DC-B40/3p	30	60	385 AC/500 DC	≤ 2.2	5 / 50	64308



Type of the arrester	In (kA)	I _{max} (kA)	U _c (V)	U _p (kV)	Packing/Box (pcs)	Catalogue number
SPD-DC-D5/3pN	5	10	385 AC/500 DC	≤ 1.2	4 / 40	64405
SPD-DC-C10/3pN	10	20	385 AC/500 DC	≤ 1.5	4 / 40	64406
SPD-DC-C20/3pN	20	40	385 AC/500 DC	≤ 1.8	4 / 40	64407
SPD-DC-B40/3pN	30	60	385 AC/500 DC	≤ 2.2	4 / 40	64408

CONTA

CONTACTORS

EL[®]MARK

FACTORS



CONTACTORS

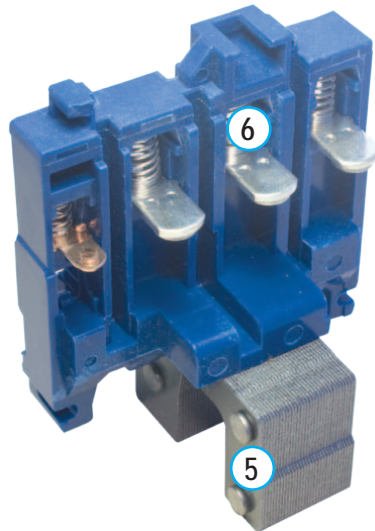
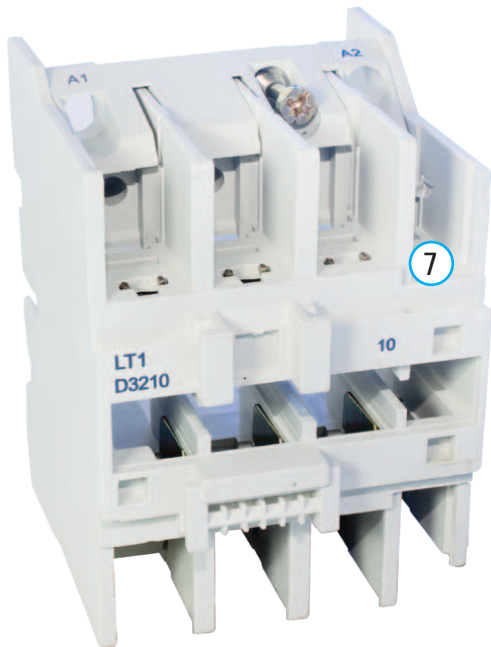

- BASE ①
- STATIC MAGNETIC CORE ②
- COIL ③
- REVERSE SPRING ④
- MOVABLE MAGNETIC CORE ⑤
- MOVABLE CONTACTS ⑥
- LID ⑦
- STATIC CONTACTS ⑧
- AUXILIARY CONTACT ⑨
- SCREWS ⑩
- TERMINAL PROTECTION CAPS ⑪

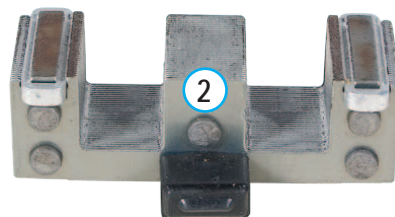
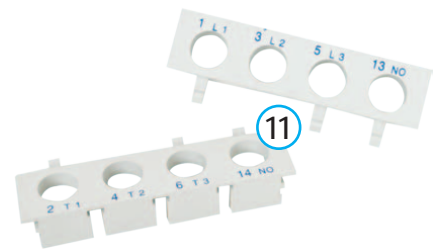
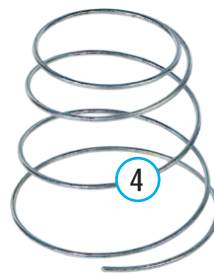
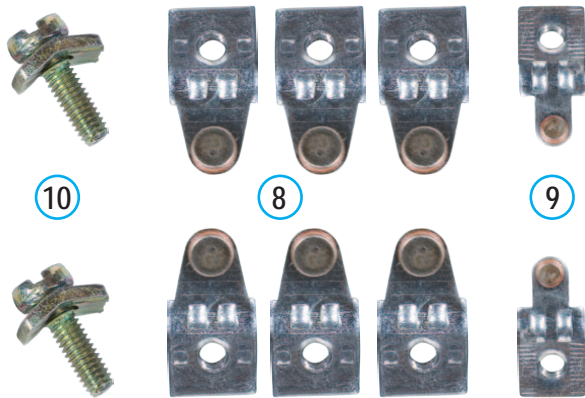



Documents corresponding to the product:
Standard EN 60947-1; EN 60 947-4-1

The products are in accordance with the directives of EC "Low voltage directives (LVD) no. 73/23 EEC" and "Electromagnetic Compatibility Directives (EMC) no. 89/336 EEC".

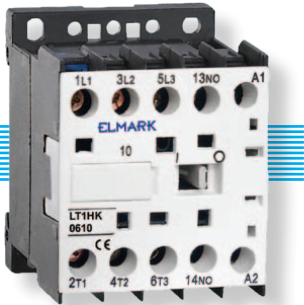

LT 1 D contactors are alternating current contactors for control of circuits and consumers operating in class AC3. It is suitable for consumers with rated current up to 95A. The contactors are offered in a type with 1 NO contact for operating circuit making and the models over 40A also have 1NC operating contactor.

Functions:

- switching on/off heavy-loaded electrical circuits at controlling signal to the coil
- making of control systems
- used as an operating element in process control panels
- remarkable with high reliability of current characteristics
- reliable separation of power contactors
- secured cover of the movable part of the contactor

Technical data:

- * Operation class: AC 3
- * Rated operating voltage of power contactors: up to 690V; 50/60Hz
- * Composition of the power contact surfaces: unalloyed copper with coating 80% AgSnO
- * Surge voltage wear resistance: >8000V
- * Rated voltage of the coil: from 12 to 400V AC
- * Coil material: pure copper type QA-1
- * Magnetic core material: alloy steel type 360
- * Moveable part material: Bakelite
- * Limits of the controlling coil voltage: from 0.8 to 1.15 U_c
- * Joining terminal: screw terminal
- * Connecting:
 - flexible conductors with or without cable terminal
 - rigid conductors
- * Electrical wear resistance (number of cycles): ≥1000000
- * Mechanical wear resistance (number of cycles): ≥10000000
- * Number of cycles per hour: 1200 UP TO 32A; 600 for 40-95A
- * Pole leaking power: up to 13W
- * **Mounting:**
 - on DIN-rail or
 - with bolts to the surface
 - mounting position: vertical gradient – maximum ± 5°
- * Plastic: wear resistance of UV rays and non-flammable (self-extinguishing material)
- * Ambient temperature: -10°C + 60°C
- * Altitude: up to 2000m

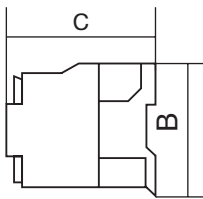

LT1-D 09-32
LT1 - K

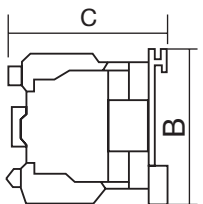
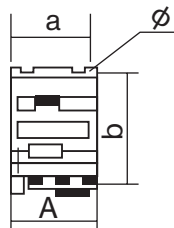

LT1-D 40-65

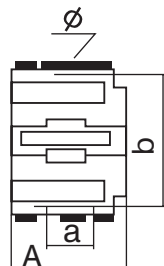

Type	Overall dimensions (mm)					
	a	b	Ø	A	B	C
LT-K 06-12	34/35	45	4.5	45	50	50
LT-D 09-12	34/35	50/60	4.5	47	70	82
LT1 D18	34/35	50/60	4.5	47	70	87
LT1 D25	40	48	4.5	57	80	95
LT1 D32	40	48	4.5	57	80	100
LT-D 40-65	40	100/110	6.5	77	126	116
LT-D 80-95	40	100/110	6.5	87	126	127

Type number	Rated capacity (kW)					Coil capacity (VA)		Rated current in AC-3 440V to up	Tightening moment (N.m)	Section of the power supply conductor	Coil voltage (V)	Packing/Box (pcs)	Catalogue number
	220V 230V	380V 400V	415V	440V	660V 690V	closed	open						
LT 1 - K 0610 1NO	1.5	2.2	2.2	2.2	3	7	60	6A	1.7	4	230	1 / 100	23061E
											400	1 / 100	23062E
											12	1 / 100	23063E
											24	1 / 100	23064E
											36	1 / 100	23065E
											48	1 / 100	23066E
											110	1 / 100	23067E

Type number	Rated capacity (kW)					Coil capacity (VA)		Rated current in AC-3 440V to up	Tightening moment (N.m)	Section of the power supply conductor	Coil voltage (V)	Packing/Box (pcs)	Catalogue number
	220V 230V	380V 400V	415V	440V	660V 690V	closed	open						
LT 1 - K 0910 1NO	2.2	3.7	3.7	3.7	4	7	60	9A	1.7	4	230	1 / 100	23091E
											400	1 / 100	23092E
											12	1 / 100	23093E
											24	1 / 100	23094E
											36	1 / 100	23095E
											48	1 / 100	23096E
											110	1 / 100	23097E

Type number	Rated capacity (kW)					Coil capacity (VA)		Rated current in AC-3 440V to up	Tightening moment (N.m)	Section of the power supply conductor	Coil voltage (V)	Packing/Box (pcs)	Catalogue number
	220V 230V	380V 400V	415V	440V	660V 690V	closed	open						
LT 1 - K 1210 1NO	3	4	4	4	5	7	60	12A	1.7	4	230	1 / 100	23121E
											400	1 / 100	23122E
											12	1 / 100	23123E
											24	1 / 100	23124E
											36	1 / 100	23125E
											48	1 / 100	23126E
											110	1 / 100	23127E

Type number	Rated capacity (kW)					Coil capacity (VA)		Rated current in AC-3 440V to up	Tightening moment (N.m)	Section of the power supply conductor	Coil voltage (V)	Packing/Box (pcs)	Catalogue number
	220V 230V	380V 400V	415V	440V	660V 690V	closed	open						
LT1 - D0910 1NO	2.2	4	4	4	5.5	7	60	9A	1.7	4	230	1 / 50	23091
											400	1 / 50	23092
											12	1 / 50	23093
											24	1 / 50	23094
											36	1 / 50	23095
											48	1 / 50	23096
											110	1 / 50	23097

Type number	Rated capacity (kW)					Coil capacity (VA)		Rated current in AC-3 440V to up	Tightening moment (N.m)	Section of the power supply conductor	Coil voltage (V)	Packing/Box (pcs)	Catalogue number
	220V 230V	380V 400V	415V	440V	660V 690V	closed	open						
LT1 - D0901 1NC	2.2	4	4	4	5.5	7	60	9A	1.7	4	230	1 / 50	23273
											400	1 / 50	23270
											12	1 / 50	23271
											24	1 / 50	23272
											36	1 / 50	23277
											48	1 / 50	23278
											110	1 / 50	23279

Type number	Rated capacity (kW)					Coil capacity (VA)		Rated current in AC-3 440V to up	Tightening moment (N.m)	Section of the power supply conductor	Coil voltage (V)	Packing/Box (pcs)	Catalogue number
	220V 230V	380V 400V	415V	440V	660V 690V	closed	open						
LT1 - D1210 1NO	3	5.5	5.5	5.5	7.5	7	60	12A	1.7	4	230	1 / 50	23121
											400	1 / 50	23122
											12	1 / 50	23123
											24	1 / 50	23124
											36	1 / 50	23125
											48	1 / 50	23126
110	1 / 50	23127											

Type number	Rated capacity (kW)					Coil capacity (VA)		Rated current in AC-3 440V to up	Tightening moment (N.m)	Section of the power supply conductor	Coil voltage (V)	Packing/Box (pcs)	Catalogue number
	220V 230V	380V 400V	415V	440V	660V 690V	closed	open						
LT1 - D1201 1NC	3	5.5	5.5	5.5	7.5	7	60	12A	1.7	4	230	1 / 50	23274
											400	1 / 50	23280
											12	1 / 50	23281
											24	1 / 50	23282
											36	1 / 50	23283
											48	1 / 50	23284
110	1 / 50	23285											

Type number	Rated capacity (kW)					Coil capacity (VA)		Rated current in AC-3 440V to up	Tightening moment (N.m)	Section of the power supply conductor	Coil voltage (V)	Packing/Box (pcs)	Catalogue number
	220V 230V	380V 400V	415V	440V	660V 690V	closed	open						
LT1 - D1810 1NO	4	7.5	9	9	10	7	60	18A	1.7	6	230	1 / 50	23181
											400	1 / 50	23182
											12	1 / 50	23183
											24	1 / 50	23184
											36	1 / 50	23185
											48	1 / 50	23186
110	1 / 50	23187											

Type number	Rated capacity (kW)					Coil capacity (VA)		Rated current in AC-3 440V to up	Tightening moment (N.m)	Section of the power supply conductor	Coil voltage (V)	Packing/Box (pcs)	Catalogue number
	220V 230V	380V 400V	415V	440V	660V 690V	closed	open						
LT1 - D1801 1NC	4	7.5	9	9	10	7	60	18A	1.7	6	230	1 / 50	23275
											400	1 / 50	23286
											12	1 / 50	23287
											24	1 / 50	23288
											36	1 / 50	23289
											48	1 / 50	23290
110	1 / 50	23291											

Type number	Rated capacity (kW)					Coil capacity (VA)		Rated current in AC-3 440V to up	Tightening moment (N.m)	Section of the power supply conductor	Coil voltage (V)	Packing/Box (pcs)	Catalogue number
	220V 230V	380V 400V	415V	440V	660V 690V	closed	open						
LT1 - D2510 1NO	5.5	11	11	11	15	7.5	90	25A	2.5	6	230	1 / 50	23251
											400	1 / 50	23252
											12	1 / 50	23253
											24	1 / 50	23254
											36	1 / 50	23255
											48	1 / 50	23256
110	1 / 50	23257											

Type number	Rated capacity (kW)					Coil capacity (VA)		Rated current in AC-3 440V to up	Tightening moment (N.m)	Section of the power supply conductor	Coil voltage (V)	Packing/Box (pcs)	Catalogue number
	220V 230V	380V 400V	415V	440V	660V 690V	closed	open						
LT1 - D2501 1NC	5.5	11	11	11	15	7.5	90	25A	2.5	6	230	1 / 50	23276
											400	1 / 50	23292
											12	1 / 50	23293
											24	1 / 50	23294
											36	1 / 50	23295
											48	1 / 50	23296
110	1 / 50	23297											

Type number	Rated capacity (kW)					Coil capacity (VA)		Rated current in AC-3 440V to up	Tightening moment (N.m)	Section of the power supply conductor	Coil voltage (V)	Packing/Box (pcs)	Catalogue number
	220V 230V	380V 400V	415V	440V	660V 690V	closed	open						
LT1 - D3210 1NO	7.5	15	15	15	18.5	7.5	90	32A	2.5	10	230	1 / 50	23321
											400	1 / 50	23322
											12	1 / 50	23323
											24	1 / 50	23324
											36	1 / 50	23325
											48	1 / 50	23326
											110	1 / 50	23327

Type number	Rated capacity (kW)					Coil capacity (VA)		Rated current in AC-3 440V to up	Tightening moment (N.m)	Section of the power supply conductor	Coil voltage (V)	Packing/Box (pcs)	Catalogue number
	220V 230V	380V 400V	415V	440V	660V 690V	closed	open						
LT1 - D4011 1NO+1NC	11	18.5	22	22	30	20	200	40A	5	16	230	1 / 20	23401
											400	1 / 20	23402
											12	1 / 20	23403
											24	1 / 20	23404
											36	1 / 20	23405
											48	1 / 20	23406
											110	1 / 20	23407

Type number	Rated capacity (kW)					Coil capacity (VA)		Rated current in AC-3 440V to up	Tightening moment (N.m)	Section of the power supply conductor	Coil voltage (V)	Packing/Box (pcs)	Catalogue number
	220V 230V	380V 400V	415V	440V	660V 690V	closed	open						
LT1 - D5011 1NO+1NC	15	22	25	25	33	20	200	50A	5	25	230	1 / 20	23501
											400	1 / 20	23502
											12	1 / 20	23503
											24	1 / 20	23504
											36	1 / 20	23505
											48	1 / 20	23506
											110	1 / 20	23507

Type number	Rated capacity (kW)					Coil capacity (VA)		Rated current in AC-3 440V to up	Tightening moment (N.m)	Section of the power supply conductor	Coil voltage (V)	Packing/Box (pcs)	Catalogue number
	220V 230V	380V 400V	415V	440V	660V 690V	closed	open						
LT1 - D6511 1NO+1NC	18.5	30	37	37	37	20	200	65A	5	25	230	1 / 20	23651
											400	1 / 20	23652
											12	1 / 20	23653
											24	1 / 20	23654
											36	1 / 20	23655
											48	1 / 20	23656
											110	1 / 20	23657

Type number	Rated capacity (kW)					Coil capacity (VA)		Rated current in AC-3 440V to up	Tightening moment (N.m)	Section of the power supply conductor	Coil voltage (V)	Packing/Box (pcs)	Catalogue number
	220V 230V	380V 400V	415V	440V	660V 690V	closed	open						
LT1 - D8011 1NO+1NC	22	37	45	45	45	20	200	80A	9	50	230	1 / 15	23801
											400	1 / 15	23802
											12	1 / 15	23803
											24	1 / 15	23804
											36	1 / 15	23805
											48	1 / 15	23806
											110	1 / 15	23807

Type number	Rated capacity (kW)					Coil capacity (VA)		Rated current in AC-3 440V to up	Tightening moment (N.m)	Section of the power supply conductor	Coil voltage (V)	Packing/Box (pcs)	Catalogue number
	220V 230V	380V 400V	415V	440V	660V 690V	closed	open						
LT1 - D9511 1NO+1NC	25	45	45	45	45	20	200	95A	9	50	230	1 / 15	23951
											400	1 / 15	23952
											12	1 / 15	23953
											24	1 / 15	23954
											36	1 / 15	23955
											48	1 / 15	23956
											110	1 / 15	23957



Documents corresponding to the product:

Standard EN 60947-1; EN 60 947-4-1
 The products are in accordance with the directives of EC "Low voltage directives (LVD) no. 73/23 EEC" and "Electromagnetic Compatibility Directives (EMC) no. 89/336 EEC".

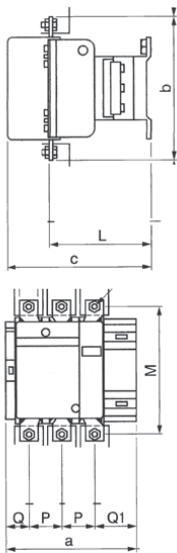

The contactors LT 1- F are alternating current contactors used to control circuits and consumers operating in normal working conditions with switching on /off the consumer and dirty working environment. They are suitable for consumers with electrical power consumption from 115A to 800A.

Functions:

- frequently switching on/off heavy-loaded electrical circuits at controlling signal to the coil
- making of systems for consumers' control
- used as an operating element in process control panels
- remarkable with high reliability of current characteristics
- reliable separation of power contactors
- secured cover of the movable part of the contactor

Technical data:

- * Operation class: AC 3
- * Rated operating voltage of power contactors: up to 1000V; 50/60Hz
- * Composition of the power contact surfaces: unalloyed copper with coating 80% AgSnO
- * Surge voltage wear resistance: >8000V
- * Coil composition: pure coil copper QA-1 type
- * Magnetic core composition: steel alloy 360
- * Movable part composition: bakelite
- * Rated voltage of the coil: 230 and 400V AC
- * Limits of the controlling coil voltage: from 0.8 to 1.15 U_c
- * Joining terminal: screw terminal
- * Connecting:
 - flexible conductors with or without cable terminal
 - rigid conductors
 - rail
- * Electrical wear resistance (number of cycles): ≥10000000
- * Mechanical wear resistance (number of cycles): ≥10000000
- * Number of cycles (switching on) per hour: 200
- * Pole leaking power: from 16 to 80W
- * Mounting:
 - with bolts to the surface
 - mounting position: vertical gradient – maximum ± 10°C
- * Plastic: wear resistance of UV rays and non-flammable (self-extinguishing material)
- * Ambient temperature: -10°C + 60°C
- * Altitude: up to 2000m

Type	Overall dimensions (mm)							
	a	b	c	L	M	O	Q1	P
LT 1 F150	163.5	170	171	107	150	26	57.5	40
LT 1 F225	168.5	197	181	113.5	172	21	51.5	48
LT 1 F265	201.5	203	181	141	178	39	66.5	48
LT 1 F400	213	206	219	145	182	43	74	48
LT 1 F630	309	304	255	155	264	60	89	80
LT 1 F800	309	304	255	155	264	60	89	80

Type number	Motor rated capacity (kW)							Coil capacity (VA)		Rated current in AC-3 440V to up	Tightening moment (N.m)	Coil voltage (V)	Packing/Box (pcs)	Catalogue number												
	220V 230V	380V 400V	415V	440V	500V	660V 690V	1000V	closed	open																	
LT1 - F115	30	55	59	59	59	80	60	45	550	115 A	18	230	1/4	23111												
												400	1/4	23112												
												12	1/4	23113												
												24	1/4	23114												
												36	1/4	23115												
												48	1/4	23116												
LT1 - F150	40	75	80	80	90	100	65	45	550	150 A	25	110	1/4	23117												
												230	1/4	23151												
												400	1/4	23152												
												12	1/4	23153												
												24	1/4	23154												
												36	1/4	23155												
LT1 - F225	63	110	110	110	129	129	100	55	805	225 A	35	110	1/4	23157												
												230	1/2	23861												
												400	1/2	23862												
												12	1/2	23863												
												24	1/2	23864												
												36	1/2	23865												
LT1 - F265	75	132	140	140	160	160	147	10	700	265 A	35	48	1/2	23866												
												110	1/2	23867												
												230	1/2	23261												
												400	1/2	23262												
												12	1/2	23263												
												24	1/2	23264												
LT1 - F400	110	200	220	250	257	280	185	18	1000	400 A	50	36	1/2	23265												
												48	1/2	23266												
												110	1/2	23267												
												230	1/1	23751												
												400	1/1	23752												
												LT1 - F630	200	335	375	400	400	450	450	25	1500	630 A	50	400	1/1	23771
400	1/1	23772																								
230	1/1	23881																								
400	1/1	23882																								
LT1 - F800	250	450	450	450	450	475	450	15	1300	800 A	50													400	1/1	23882
																								400	1/1	23882

Note: At mounting the containers from the series in control schemes a distance must be provided at the side of the contactor in case of eventual coil change.

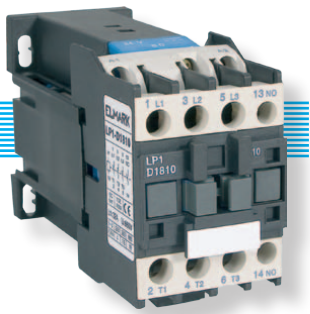

Documents corresponding to the product:

Standard EN60947-1; EN 60947-4-1

The products are in accordance with the directives of EC "Low voltage directives (LVD) no. 73/23 EEC" and "Electromagnetic Compatibility Directives (EMC) no. 89/336 EEC"

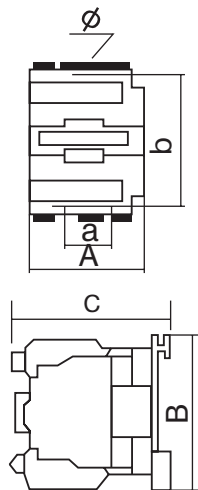

LP1-D 09-95

The contactors LP1 D are alternating current contactors with constant current coil for control. The power plugs of the contactor are designed for control of alternating current circuits and consumers operating in normal operating class AC-3 with frequently switching on/off the consumer and dirty working environment. The contactors are suitable for consumers with electrical power consumption from 9A to 225A.

Functions:

- switching on/off alternating current consumers in direct current controlling schemes at controlling signal to the coil
- making of systems for consumers' control
- used as an operating element in process control panels
- remarkable with high reliability of current characteristics
- reliable separation of power contacts
- secured cover of the movable part of the contactor

Technical data:

- * Rated operating voltage of the controlling coil: from 12V DC to 220V DC
- * Rated operating voltage of the power circuit: up to 690V DC
- * insulation voltage: 690V
- * Surge voltage wear resistance: >8000V
- * Limits of the controlling coil voltage: from 0.8 to 1.15 U_c
- * Joining terminal: screw terminal
- * Connecting:
 - flexible conductors with or without cable terminal
 - rigid conductors
- * Electrical wear resistance (number of cycles): ≥10000000
- * Mechanical wear resistance (number of cycles): ≥10000000
- * Number of cycles per hour: 1200 up to 32A; 600 for 40-95A
- * Pole leaking power: up to 13W
- * Mounting:
 - on DIN-rail or
 - with bolts to the surface
 - mounting position: vertical gradient – maximum ± 5°
- * Plastic: wear resistance of UV rays and non-flammable (self-extinguishing material)
- * Ambient temperature: -10°C + 60°C
- * Altitude: up to 2000m

Type	Overall dimensions (mm)				
	A	B	C	a	b
LP 1 D0910	47	76	95	34/35	50/60
LP 1 D1210	47	76	95	34/35	50/60
LP 1 D1810	47	76	95	34/35	50
LP 1 D2510	57	86	101	40	50
LP 1 D3210	57	86	101	40	50
LP 1 D4011	77	129	176	40	100
LP 1 D5011	77	129	176	40	100
LP 1 D6511	77	129	176	40	100
LP 1 D9511	87	129	182	40	100
LP 1 F115	163.5	170	171	40	150
LP 1 F150	163.5	170	171	40	150
LP 1 F225	168.5	197	181	48	172

Type	Rated current (A)	Auxiliary contact (pcs.)	Rated capacity of the consumer (kW)					Packing/Box (pcs)	Catalogue number according to the coil voltage (V DC)					
			230V	400V	415V	440V	690V		12	24	36	48	110	230
LP 1 D0910	9	1NO	2.20	4.00	4.00	4.00	5.50	1/40	23962	23098	23130	23971	23980	23139
LP 1 D1210	12	1NO	3.00	5.50	5.50	5.50	7.50	1/40	23963	23128	23131	23972	23981	23140
LP 1 D1810	18	1NO	4.00	7.50	7.50	7.50	10.0	1/40	23964	23188	23132	23973	23982	23141
LP 1 D2510	25	1NO	5.50	11.0	11.0	11.0	15.0	1/30	23925	23258	23133	23974	23983	23142
LP 1 D3210	32	1NO	7.50	15.0	15.0	15.0	18.5	1/30	23966	23328	23134	23975	23984	23143
LP 1 D4011	40	1NO+1NC	11.0	18.5	18.5	18.5	30.0	1/10	23967	23408	23135	23976	23985	23144
LP 1 D5011	50	1NO+1NC	15.0	22.0	22.0	22.0	33.0	1/10	23968	23508	23136	23977	23986	23145
LP 1 D6511	65	1NO+1NC	18.5	30.0	30.0	30.0	37.0	1/10	23969	23658	23137	23978	23987	23146
LP 1 D9511	95	1NO+1NC	25.0	45.0	45.0	45.0	45.0	1/10	23970	23958	23138	23979	23988	23147
LP 1 F115	115	1NO	30.0	55.0	59.0	59.0	80.0	1/4	23911	23118	23914	23917	23989	23148
LP 1 F150	150	1NO	40.0	75.0	80.0	80.0	100	1/4	23912	23158	23915	23918	23990	23149
LP 1 F225	225	1NO	63.0	110	110	110	129	1/2	23913	23228	23916	23919	23994	23201



Documents corresponding to the product:

Standard EN60947-1; EN 60947-4-1

The products are in accordance with the directives of EC "Low voltage directives (LVD) no. 73/23 EEC" and "Electromagnetic Compatibility Directives (EMC) no. 89/336 EEC"

The AC contactors CJ19-43 are specially designed electrical devices for commutation of three phase capacitors used for power correction. They are alternating current contactor LT1 Dxx with mounted a group for peak current lowering from the transitional process of the capacitor's switching on/off. This group is a combination of current limiting resistors, switched on in the beginning of the transitional process (switching on/off of the capacitor group). The contactors are suitable for capacitors with rate up to 50 kVAr.

Functions:

- switching on/off of capacitors for reactive power compensation
- making of systems for compensation of the energy reactive component
- lowering of the peak transitional currents at switching on/off of the capacitor
- remarkable with high reliability of current characteristics
- reliable separation of power contacts
- secured part of the contactor against consumer contact
- do not allow manual operation

Technical data:

- * Operation class: AC 6
- * Rated operating voltage of the controlling coil: 230V AC; 50/60Hz
- * Rated operating voltage of the power circuit: up to 690V AC
- * insulation voltage: 690V
- * Surge voltage wear resistance: >8000V
- * Limits of the controlling coil voltage: from 0.8 to 1.15 U_c
- * Number of the contacts: 3 NO power contacts +1NO operative
- * Joining terminal: screw terminal
- * Connecting:
 - flexible conductors with or without cable terminal
 - rigid conductors
- * Electrical wear resistance (number of cycles): ≥300000
- * Mechanical wear resistance (number of cycles): ≥1000000
- * Number of cycles (switching on) per hour: up to 600
- * Pole leaking power: up to 13W
- * Mounting:
 - on DIN-rail or
 - with bolts to the surface
 - mounting position: vertical gradient – maximum ± 5°
- * Plastic: wear resistance of UV rays and non-flammable (self-extinguishing material)
- * Ambient temperature: -10°C + 60°C
- * Altitude: up to 2000m

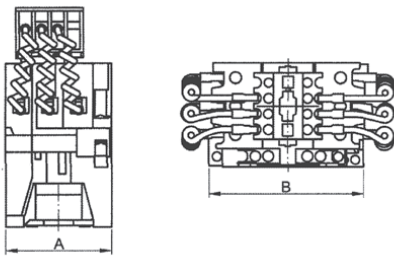

Type	Overall dimensions (mm)			
	A	B	C	D
CJ19-32 DPK	56	74	130	150
CJ19-40 DPK	75	127	180	150
CJ19-65 DPK	85	127	200	157
CJ19-95 DPK	85	127	200	157
CJ19-115DPK	122	165	230	157
CJ19-150DPK	122	165	230	157
CJ19-170DPK	122	165	230	157

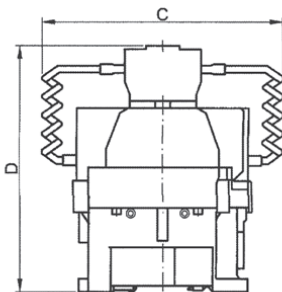

Type	Rated current (A)	Rated capacity of the consumer (kVAr)		Coil voltage (V)	Packing/Box (pcs)	Catalogue number
		400/440V	690V			
CJ19-32 DPK	32	8	12.5	230	1/20	23932
CJ19-32 DPK	32	8	12.5	400	1/20	23910
CJ19-40 DPK	40	12.5	15	230	1/16	23900
CJ19-40 DPK	40	12.5	15	400	1/16	23940
CJ19-65 DPK	65	25	30	230	1/16	23961
CJ19-65 DPK	65	25	30	400	1/16	23965
CJ19-95 DPK	95	30	36	230	1/16	23909
CJ19-95 DPK	95	30	36	400	1/16	23995
CJ19-115 DPK	115	35	40	230	1/4	23991
CJ19-150 DPK	150	40	50	230	1/4	23992
CJ19-170 DPK	170	50	60	230	1/4	23993



Documents corresponding to the product:

Standard EN60947-1; EN 60947-4-1

The products are in accordance with the directives of EC "Low voltage directives (LVD) no. 73/23 EEC" and "Electromagnetic Compatibility Directives (EMC) no. 89/336 EEC"

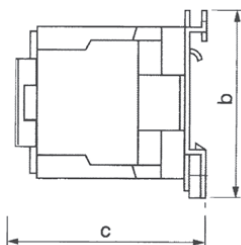
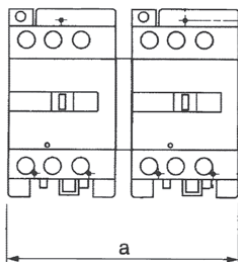

LT 4-Dxx series contactors are specially designed electromagnetic devices for commutation of three phase induction motor with reversing controlling scheme. They represent two alternating current contactors LT 4-Dxx series factory mechanically joined together. The mechanical joining also provides locking of the contactors against simultaneous switching on. The contactor is used for reverse control of induction motors with shortly joined rotor. The contactors from the series are offered for consumers up to 95A.

Functions:

- switching on of electrical motors in one direction of rotation and reversing of the rotation direction at outside command
- making of control systems
- remarkable with high reliability of current characteristics
- reliable switching on or separation of power contacts
- secured part of the contactors against consumer contact
- secured cover of the movable part of the contactor
- impossibility for simultaneous switching on of the two contactors from the group due to mechanical locking

Technical data:

- * Operation class: AC 3
- * Rated operating voltage of the controlling coil: 230V AC; 50/60 Hz
- * Rated operating voltage of the power circuit: up to 690V AC
- * insulation voltage: 690V
- * Surge voltage wear resistance: >8000V
- * Limits of the controlling coil voltage: from 0.8 to 1.15 U_c
- * Number of plugs: 3 NO power contacts +1NO operative (for contactors over 40A there is also additional 1NC contact)
- * Joining terminal: screw terminal
- * Connecting:
 - flexible conductors with or without cable terminal
 - rigid conductors
- Note: The contactors are offered without fabric cabling
- * Electrical wear resistance (number of cycles): ≥1 000 000
- * Mechanical wear resistance (number of cycles): ≥10 000 000
- * Number of cycles (switching on) per hour: up to 600
- * Pole leaking power: up to 13W
- * Mounting:
 - on DIN-rail or
 - with bolts to the surface
 - mounting position: vertical gradient – maximum ± 5°
- * Plastic: wear resistance of UV rays and non-flammable (self-extinguishing material)
- * Ambient temperature: -10°C + 60°C
- * Altitude: up to 2000m

Type	Overall dimensions (mm)		
	A	B	C
LT 4 - D1810	100	70	83
LT 4 - D2510	130	80	98
LT 4 - D3210	130	80	105
LT 4 - D4011	167	126	116
LT 4 - D6511	167	126	116
LT 4 - D9511	182	127	127

Type	Rated current (A)	Rated capacity of the consumer (kW)					Packing/Box (pcs)	Catalogue number
		230V	400V	415V	440V	690V		
LT 4 D1810	18	4	7.5	7.5	7.5	10	1 / 20	23301
LT 4 D2510	25	5.5	11	11	11	15	1 / 20	23302
LT 4 D3210	32	7.5	15	15	15	18.5	1 / 20	23303
LT 4 D4011	40	11	18.5	18.5	18.5	30	1 / 8	23304
LT 4 D6511	65	18.5	30	30	30	37	1 / 8	23305
LT 4 D9511	95	25	45	45	45	45	1 / 6	23306

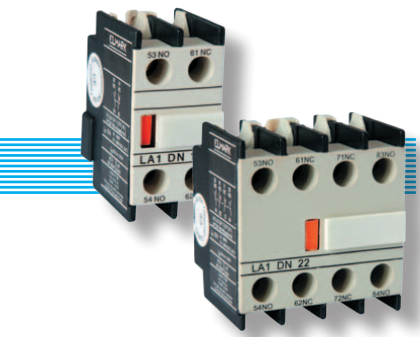

Auxiliary contacts

At necessity the element provide auxiliary number of contacts. They are specially designed for mounting on the movable part of the magnetic core of the contactors LT 1K/D series.

Functions:

- extending the number of the operative contactors up to 4 in different Combinations
- switches on simultaneously with the other contact system of the contactor

* Operation class: AC 3

* insulation voltage: 690V

* Joining terminal: screw terminal

* Connecting:

- flexible conductors with or without cable terminal
- rigid conductors

* Mounting:

- on the movable cover of the contactor through pinching
- mounting position: vertical gradient – maximum $\pm 5^\circ$

* Plastic: wear resistance of UV rays and non-flammable (self-extinguishing material)

Documents corresponding to the product:

Standard EN 60947-4-1

The products are in accordance with the directives of EC "Low voltage directives (LVD) no. 73/23 EEC" and "Electromagnetic Compatibility Directives (EMC) no. 89/336 EEC"

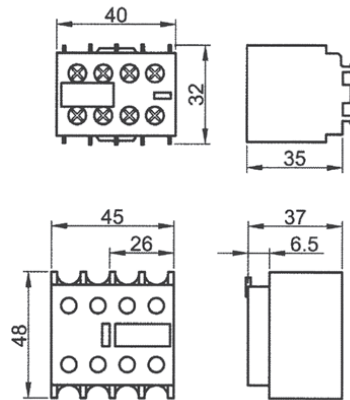

Type	Number of contacts	Catalogue number
LT01-DN02	2NC	23002
LT01-DN11	NO+NC	23011
LT01-DN20	2NO	23020
LT01-DN22	2NO+2NC	23022
LT01-DN40	4NO	23040
LT01-DN04	4NC	23004
LT01-KN11	NO+NC	23001
LT01-KN22	2NO+2NC	23003



Auxiliary contacts LT03-DN11

Providing on necessity additional number of plug points and are mounted sideward to the movable part of the magnetic cores of contactors of the series LT1 D. Variants with two additional plug points NO and NC are offered.

Functions:

- expanding the number of the operational plug points
- switching on simultaneously with the rest of the contact system of the contactor

Technical characteristics:

- * Environment operational regime: AC 3
- * Insulation voltage: 690V
- * Double connector: screw connector
- * Connection:
 - flexible conductors with or without cable end
 - solid conductors
- * Mounting method:
 - mounting position – sideward to the contactor
- * Plastic: resistant to UV and non-burning (self-extinguishing material)

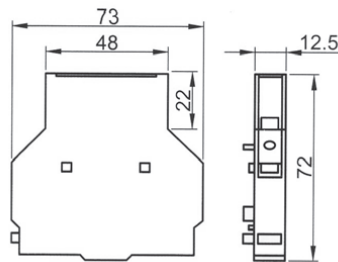

Type	Catalogue number
LT03-DN11	23311



Time delay contact block LT02-Dxx

LT02-Dxx is designed to set time intervals from 0.1 to 180s in different control schemes. It is used most frequently in combination with contactors from LT1-Dxx series to form “star/delta” starters for electrical motor control, as it provides the necessary time for motor winding.

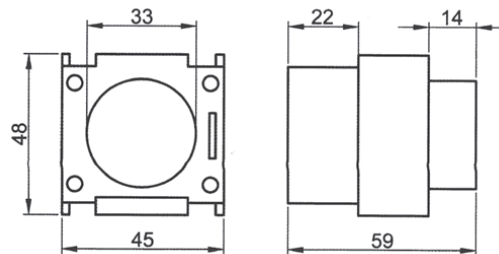

Type	Number of contacts	Time delay	Catalogue number
LT02-DT0	NO+NC	0.1–3s	23901
LT02-DT2	NO+NC	0.1–30s	23902
LT02-DT4	NO+NC	10–180s	23903



Modular contactors K series are used for commutation of mono-phase and three-phase low power electrical consumers. They provide connection between the consumers in small overall dimensions, silent work, mounting only at DIN-rails.

Functions:

- switching on of consumers
- making of control systems
- remarkable with high reliability of current characteristics
- reliable switching on or separation of power contacts

Technical data:

- * Operation class: AC 7a
- * Rated operating voltage of the controlling coil: 230V AC; 50/60 Hz
- * Rated operating voltage of the power circuit: up to 690V AC
- * insulation voltage: 690V
- * Surge voltage wear resistance: >8000V
- * Joining terminal: screw terminal
- * Connecting:
 - flexible conductors with or without cable terminal
 - rigid conductors
- * Mounting:
 - on DIN-rail or
 - mounting position: vertical gradient – maximum ± 5°
- * Plastic: wear resistance of UV rays and non-flammable (self-extinguishing material)
- * Ambient temperature: -10°C + 60°C
- * Altitude: up to 2000m

Documents corresponding to the product:

Standard EN 61095

The products are in accordance with the directives of EC "Low voltage directives (LVD) no. 73/23 EEC" and "Electromagnetic Compatibility Directives (EMC) no. 89/336 EEC"



Type	In	Coil voltage (V)	Contacts	Packing/Box (pcs)	Catalogue number
K20	20A	230V	2NO	1 / 17 / 170	23008
K20	20A	230V	NO+NC	1 / 17 / 170	23007
K20	20A	230V	2NC	1 / 17 / 170	23009
K40	40A	230V	2NO+2NC	1 / 5 / 50	23422
K40	40A	230V	4NO	1 / 5 / 50	23409

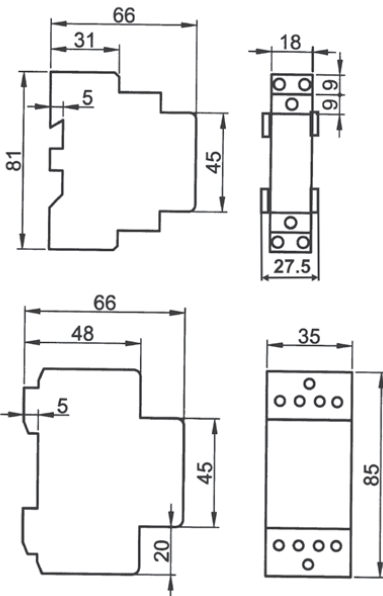

CAPACITY COEFFICIENT COMPENSATION

CAPACITY COEFFICIENT COMPENSATION

EL[®]MARK

TYTY COMPENSATION



CAPACITY

COEFFICIENT COMPENSATION

Complex compensating devices

The use of electrical energy in industry is invariably connected with its transformation. The development of semi-conductor elements and the broader coming of semi-conductor transformers, frequency control, welding machines and electrical arc furnaces in industrial projects have a negative impact over the electrical power quality in the electro distributing systems. Induction machines need reactive energy to create electromagnetic field. The reactive component of current is taken from the electro distributing systems but it leads to additional losses in the power supply system and makes shorter the exploitation term of electrical devices. This leads to curving of the sinusoid form of current and voltage and interferences with harmonic character. Compensating the reactive power means to fill up the system in such a way that the needed reactive power to be created from the compensating device instead of being taken from the electro transportation system. This leads to killing the voltage fall and cable losses and increasing the outlet power of the power transporters and cutting down the bills for overconsumption of reactive energy paid by consumers to the electricity supply company. In practice compensating the reactive energy and high harmonics through LC filters combined in compensating installations has the broadest spreading.

There are several types of compensation according to their location:

* individual compensation – when to every single motor or consumer is mounted a compensating system. It is applied to powerful motors and transformers with fixed capacity.

* installation compensation – when the consumers from the whole section (workshop) are grouped and compensation is accomplished for the whole section.

* overall compensation – accomplished at full compensation in the inlet of the installation.

According to the type of the compensating devices compensation can be:

* passive – when the system supplies constant reactive power. In this case the system does not react to changes in the size and nature of the harmonic components and also to the per cent increase of the reactive energy in time.

* active – broader spread. The system controls the form of the consumed current and generates different capacity depending on the load changes.

When designing the electro distributing system of industrial projects the following tasks are taken into consideration:

* defining the factor of non-sinusoid of the consumers and the voltage harmonic components

* defining the additional loading of the capacitor batteries from the harmonic components and calculating the filtering elements if needed

The calculation of the compensating device capacity is done by reading the reactive energy of the system and the working time of the system. Compensating devices represent a device of one or several metal boxes with common rail system, automatic regulator for $\cos\phi$ control RPSF-xx series, different number of capacitor batteries (according to the capacity of the device) with different capacity HY 111 series, contactors for capacitor batteries control CJ 19-43 series, protective elements, etc.

The broadest spreading of compensation has acquired the compensation of harmonics and reactive energy with capacitors for high voltage. Capacitors HY 111 series are voltage remeasured and are able to endure overload from harmonic components up to 7% from the basic harmonics. They are used in systems with high harmonics foul up to 25%.

The high harmonics composition is defined after measuring the influence rate of each separate harmonics compared to the first one. In Bulgaria mostly spread are 5, 7, 9, 11 and 13 harmonics. The capacitors are remeasured for voltage 415V and are normally mounted right in the compensation systems.

When the high harmonics are over 25% the system is taken to be foul and in this case except using capacitors, filters for leveling the harmonics are to be used as well. These filters are calculated on the basis of the corresponding voltage harmonics and differ for the different harmonics. They are calculated using complex mathematical programme which reads the foul rate, the significance per cent of the voltage harmonic component, etc.

Capacitor batteries for reactive energy compensation



Documents corresponding to the product:
Standard EN 60831-1
EN 60831-2

Capacitor batteries HY 111 series are specially designed three phase dry capacitors for compensation of reactive energy and correction of the capacity factor. It represents an aluminum cylindrical body in which a metal polypropylene folio is mounted which does not require special impregnation. The permittivity characteristics are acquired through filling with a special mixture on a vegetable base (resins). The capacitor battery is constructed in such a way that at failure (overload from voltage, current or temperature) breaks the connection to the upper cover where are the connections to the power supply. This is done by a specially constructed valve for overpressure mounted right above the capacitor element.

The breaking of the inner couplings provides protection to the staff and environment from damage due to capacitor element failure. There is a three phase capacitor in the cylindrical body with built in resistor for rarefying the capacitors.

The capacitor battery can be used both for passive and active compensation.

Technical data:

- * Rated operating voltage: 440V; 50Hz
- * insulation voltage: 690V
- * Surge voltage wear resistance: 6kV per minute
- * Capacity: from 8 to 30 kVAR at 440V
- * Tolerance: ±5%
- * Operating temperature: -40°C - +55°C
- * Capacity losses: 0.5W/kVAR
- * Built in discharging resistance
- * Admissible current overload: twice as much the peak current
- * Discharge time: <50V per minute
- * Altitude: 2000m

Mounting:

- * With bolt M12 or M16 to a flat horizontal base

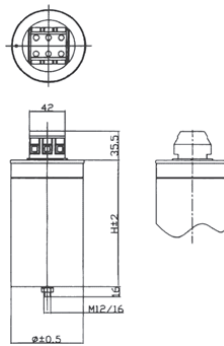

Type of the battery	Dimensions H / Ø (mm)	Operating voltage (V)	Battery capacity (kVAR)	Packing/Box (pcs)	Catalogue number
HY 111A8	230 / 80	440	8.0	6	49008
HY 111A12	230 / 85	440	12.5	6	49012
HY 111A15	230 / 85	440	15.0	6	49015
HY 111A20	240 / 115	440	20.0	6	49020
HY 111A30	280 / 115	440	30.0	6	49030
HY 111B12*	230 / 85	690	12.5	6	49031
HY 111B25*	280 / 115	690	25	6	49032

Note: *Suitable for wind generators



Controller for automatic regulation of the capacity factor (cosφ regulator)

The automatic regulators of the capacity factor RPCF-xx series are devices for monitoring of low voltage systems and control of switching on of capacitor batteries for the capacity factor compensation. There is possibility for adjustment of the system parameters and control. Manufactured by the latest CMOS technology, they are distinguished with high degree of data security, easy programming and secure control of the outlets. There is possibility for indication and setting the parameters of the power supply system as: capacity coefficient, display of the system parameters such as voltage, current and capacity, losses, protection against overload, overload indication or lack of voltage, etc.

The change of parameters is performed through a combination of buttons on the front panel. There is light diode to indicate which parameter is being displayed on the screen and which outlets are in operation. The display is four digital. There is possibility for choice of the working conditions: manual or automatic.

Technical data:

- * Rated operating voltage: 230/400V
- * Operating frequency: 45 – 65Hz
- * insulation voltage: 690V
- * Surge voltage wear resistance: 6kV per minute
- * Measurement range: from 0 to 9999kVAR
- * Measurement accurateness:
 - voltage: ±1.0%
 - current: ±1.0%
 - capacity coefficient: ±1.0%
 - reactive energy: ±2.0%
- * Operating temperature: -10-+55°C
- * Humidity: 30 – 60%
- * Display: 4 digital
- * Responsiveness: 20mA
- * Outlet: 7A
- * Number of outlets: 12 and 16
- * Altitude: up to 2500m

Mounting:

- * On the front panel of the box through cutting an opening

Type	Number of steps	Packing/Box (pcs)	Catalogue number
HY-RPCF12	12	8	49120
HY-RPCF16	16	8	49160



Documents corresponding to the product:

Standard EN 60439-1

EN 60439-2

Metal boards for making of systems for capacity factor correction

Metal boards for capacitor batteries mounting made of specially processed sheet iron with protective surface. A fan is mounted to provide temperature conditions. There is possibility a breaker to be mounted on the door. The device is protected against indirect contact to the current leading elements. It is mounted directly on the walls or floor, as at mounting on a wall it is fixed with screws to the surface. It necessary to provide enough distance for cooling of the board.

Technical data:

- * Rated voltage: 400V; 50Hz
- * insulation voltage: 690V
- * Surge voltage wear resistance: 6kV/m
- * Operating temperature: -5-+55C°
- * Maximum overloading current: 1.3xIn
- * Surface: zinc passivation
- * Colour: RAL 7032
- * Altitude: up to 2500m

Mounting:

- * on vertical or horizontal surfaces

Type	Dimensions (mm)			Packing/Box (pcs)	Catalogue number
	L	H	W		
CXF550/356/225	550	356	225	1	49225
CXF1140/450/450	1140	450	450	1	49450
CXF1730/600/600	1730	600	600	1	49600

Note: The boards are supplied with a cooling fan

DEVICES FOR CONTROL AND

PROTECTION OF ELECTRICAL MOTORS

DEVICES FOR CONTROL OF ELECTRICAL

EL[®]MARK

ELMOTORS AND PROTECTION



⚠ CAUTION:

- 1) Do not re-set while the motor is rotating
- 2) Perform parts replacement after discharge is finished
- 3) Do not connect output terminals to the power supply

DEVICES
FOR CONTROL AND PROTECTION
OF ELECTRICAL MOTORS



Documents corresponding to the product:

Standard EN 60947-1
EN 60947-4-1

The products are in accordance with the directives of EC "Low voltage directives (LVD) no 73/23 EEC" and "Electromagnetic Compatibility Directives (EMC) no. 89/336 EEC".

Thermal relays

The thermal relays LT 2- K/Exx series are devices designed for protection of induction motors from overload or overheat. They are mounted to contactors LT 1 K/Dxx series and an operating circuit for motor control is passed through their NC contacts. The operation of these devices is based on the curving of bimetal plates mounted in the thermal relay caused by the current passing through them. When the current to the consumer gets higher due to failure, the thermal current gets higher which leads to additional curving of the bimetal plates and at getting above the limit value for the plate it pushes the breaking mechanism and breaks the operating circuit. The choice of a suitable protection prevents motor's operation at unusual temperature conditions and guarantees maximum constant operation, increases the effectiveness and prolongs the term of exploitation.

Functions:

- switching off alternating current consumers at current overload
- making of control systems for consumers
- used as a protective operating element in control panels of induction motors
- remarkable with high reliability of current characteristics

Technical data:

- * Rated operating voltage: up to 690V AC; 50/60 Hz
- * Rated operating current range: up to 690V AC
- * insulation voltage: >690V
- * Surge voltage wear resistance: $\geq 60000V$
- * Joining terminal: screw terminal
- * Connecting:
 - flexible or rigid conductors with or without cable terminal for joining to the consumer
 - to the contactor through the relay terminals
 - the connecting terminals with the consumer can be adjusted according to the type of the contactor
- * Electrical wear resistance (number of cycles): ≥ 1000000
- * Mechanical wear resistance (number of cycles): ≥ 10000000
- * Indication for protection activating
- * Possibility for choice of the protection restoring (through the blue button)
- * Possibility for range adjustment of the protection activating
- * Possibility for operation at higher frequency
- * Mounting:
 - mounting to the contactor: to the terminals of the contactor as it is additionally clamped to its frame through a pin
 - mounting position: vertical gradient – maximum $\pm 5^\circ$
 - * Plastic: wear resistance of UV rays and non-flammable (self-extinguishing material)
 - * Ambient temperature: $-10^\circ C + 60^\circ C$
 - * Installation altitude: up to 2000m

Note: To protect the consumer from short circuit, before the combination contactor- thermal relay, a suitably measured breaker or safety device should be mounted.

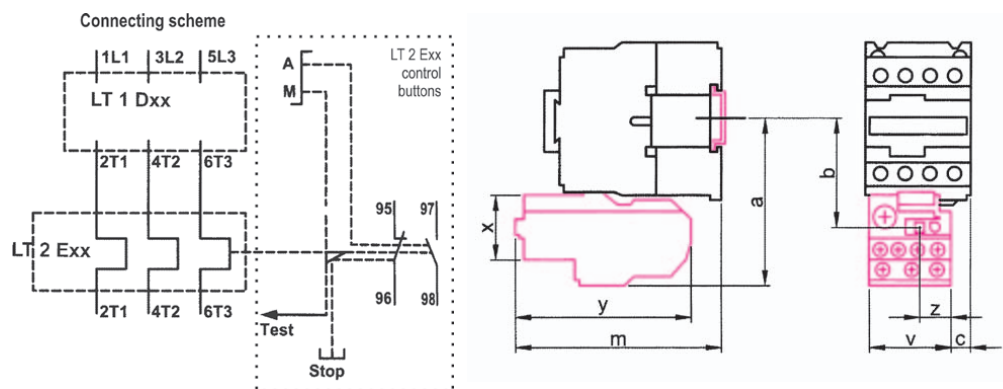
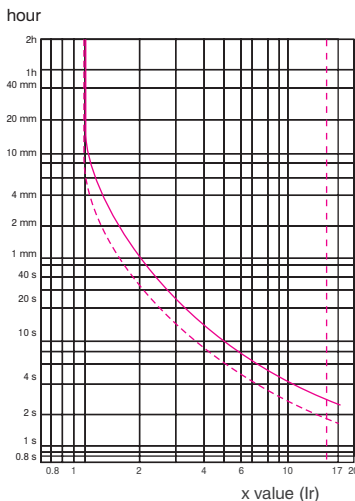

Type	Dimensions (mm)							
	a	b	c	m	x	y	v	z
LT 2 - Kxx	81	50	0	98	47	92	44	17
LT 2 - E13xx	86	55	10.7	108	47	92	44	17
LT 2 - E23xx	86	55	9	109	47	92	44	17
LT 2 - E33xx	115	76	9.5	124	54	109	70	30



For contactor LT1-K06 type	Motor capacity (kW)			Rated current (A)	Protection adjustment range	Packing/Box (pcs)	Catalogue number
	220V 230V	380V 400V	660V 690V				
LT2-K0301	-	-	-	0.16	0.10 - 0.16	1 / 100	13401
LT2-K0302	-	-	-	0.25	0.16 - 0.25	1 / 100	13402
LT2-K0303	-	-	-	0.40	0.25 - 0.40	1 / 100	13403
LT2-K0304	-	-	0.37	0.63	0.40 - 0.63	1 / 100	13404
LT2-K0305	-	-	0.55	1.00	0.63 - 1.00	1 / 100	13405
LT2-K0306	-	0.37	1.10	1.60	1.0 - 1.60	1 / 100	13406
LT2-K0307	0.37	0.75	1.50	2.50	1.6 - 2.50	1 / 100	13407
LT2-K0308	0.75	1.50	3.00	4.00	2.5 - 4.00	1 / 100	13408
LT2-K0310	1.10	2.20	4.00	6.00	4.0 - 6.00	1 / 100	13410
LT2-K0312	1.10	2.20	4.00	8.00	5.5 - 8.00	1 / 100	13411
LT2-K0314	2.20	4.00	7.50	10.0	7.0 - 10.0	1 / 100	13412



For contactors from LT1-D09 to LT1-D25 type	Motor capacity (kW)			Rated current (A)	Protection adjustment range	Packing/Box (pcs)	Catalogue number
	220V 230V	380V 400V	660V 690V				
LT2-E1301	-	-	-	0.16	0.10 - 0.16	1 / 100	13001
LT2-E1302	-	-	-	0.25	0.16 - 0.25	1 / 100	13002
LT2-E1303	-	-	-	0.40	0.25 - 0.40	1 / 100	13003
LT2-E1304	-	-	0.37	0.63	0.40 - 0.63	1 / 100	13004
LT2-E1305	-	-	0.55	1.00	0.63 - 1.00	1 / 100	13005
LT2-E1306	-	0.37	1.10	1.60	1.0 - 1.60	1 / 100	13006
LT2-E1307	0.37	0.75	1.50	2.50	1.6 - 2.50	1 / 100	13007
LT2-E1308	0.75	1.50	3.00	4.00	2.5 - 4.00	1 / 100	13008
LT2-E1310	1.10	2.20	4.00	6.00	4.0 - 6.00	1 / 100	13010
LT2-E1312	2.00	3.70	5.50	8.00	5.5 - 8.00	1 / 100	13012
LT2-E1314	2.20	4.00	7.50	10.0	7.0 - 10.0	1 / 100	13014
LT2-E1316	3.70	5.50	11.0	13.0	9.0 - 13.0	1 / 100	13016
LT2-E1321	4.00	7.50	15.0	18.0	12.0 - 18.0	1 / 100	13021
LT2-E1322	5.50	9.00	18.5	25.0	17.0 - 25.0	1 / 100	13022
LT2-E1353	9.00	11.0	18.5	33.0	23.0 - 32.0	1 / 100	13053



For contactor LT1-D32 type	Motor capacity (kW)			Rated current (A)	Protection adjustment range	Packing/Box (pcs)	Catalogue number
	220V 230V	380V 400V	660V 690V				
LT2-E2353	11	11	18.5	32	23.0 - 32.0	1 / 100	13253
LT2-E2355	15	15	22.0	36	28.0 - 36.0	1 / 100	13255



For contactors from LT1-D40 to LT1-D95 type	Motor capacity (kW)			Rated current (A)	Protection adjustment range	Packing/Box (pcs)	Catalogue number
	220V 230V	380V 400V	660V 690V				
LT2-E3355	18.5	18.5	30	40	30.0 - 40.0	1 / 50	13355
LT2-E3357	22	22	30	50	37.0 - 50.0	1 / 50	13357
LT2-E3359	30	30	37	65	48.0 - 65.0	1 / 50	13359
LT2-E3363	45	45	55	80	63.0 - 80.0	1 / 50	13363
LT2-E3365	55	55	75	93	80.0 - 93.0	1 / 50	13365



The thermomagnetic automatic breakers TM 2-Exx series are devices designed for control and protection of induction motors from overload, overheat or short circuit. The overload motor protection is carried out by the built in the breaker thermal elements, and the short circuit protection is carried out by the magnetic elements. These magnetic elements allow the adjustment of the current leakage which is 13 times the maximum current of the thermal protection. The overload protection elements include automatic compensation for the ambient temperature changes. In combination with under voltage release the thermomagnetic breaker TM 2-Exx also provides protection of the motors from fall out of a phase from the power supply. The choice of a suitable protection prevents motor's operation at unusual temperature conditions and guarantees maximum constant operation, increases the effectiveness and prolongs the term of exploitation.

Functions:

- switching off alternating current consumers at current overload
- switching off the electrical circuit to the consumer at inlet short circuit
- protects the motor at lack/lowering of the phase voltage (if there is under voltage release)
- used as a protective operating element in control panels of induction motors
- remarkable with high reliability of current characteristics
- possibility for change/choice of the protection current (according to the operating current of the motor)
- automatic compensation of the ambient temperature

Technical data:

- * Rated operating voltage: up to 690V AC; 50/60 Hz
- * Rated operating current range: from 0.1 to 80A according to the type in table 1
- * insulation voltage: 690V
- * Surge voltage wear resistance: $\geq 60000V$
- * Joining terminal: screw terminal
- * Connecting:
 - flexible or rigid conductors with or without cable terminal for joining to the consumer
 - to the contactor through the relay terminals
 - the connecting terminals with the consumer can be adjusted according to the type of the contactor
- * Electrical wear resistance (number of cycles): ≥ 1000000
- * Mechanical wear resistance (number of cycles): ≥ 10000000
- * Indication for protection activating
- * Switching on of the breaker manually with button "I" and switching off with button "O" manually or automatically at failure or after activating of the protection
- * Possibility for range adjustment of the protection activating
- * Possibility for operation at higher frequency
- * Possibility for independent operation or as an element of an automation system
- * Mounting:
 - mounting to DIN-rail
 - mounting position: vertical gradient – maximum $\pm 5^\circ$
- * Plastic: wear resistance of UV rays and non-flammable (self-extinguishing material)
- * Ambient temperature: $-10^\circ C + 60^\circ C$
- * Altitude: up to 2000m

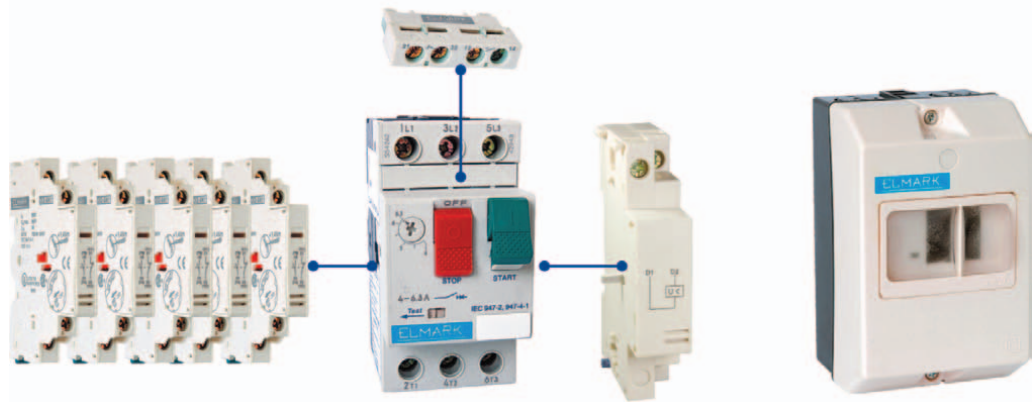
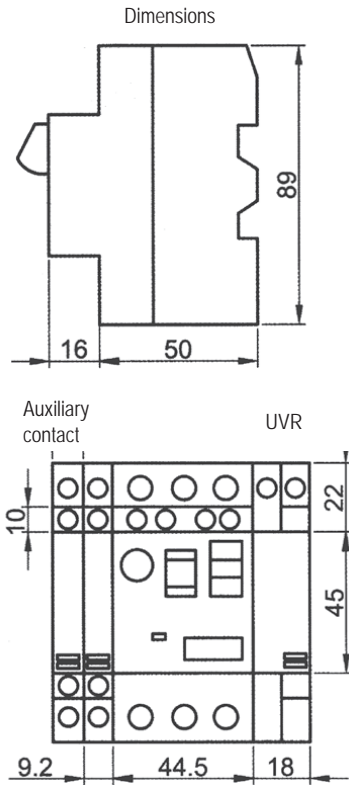

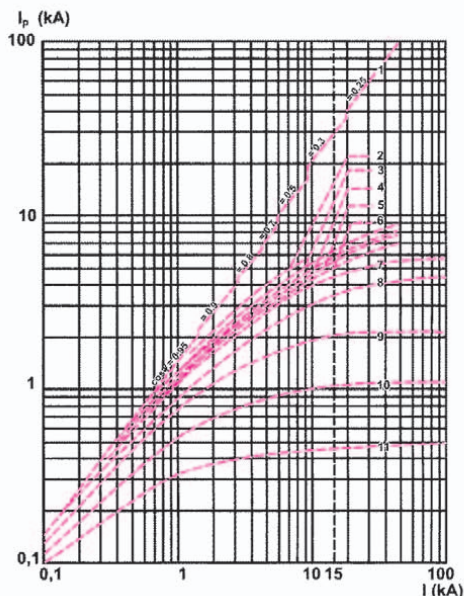
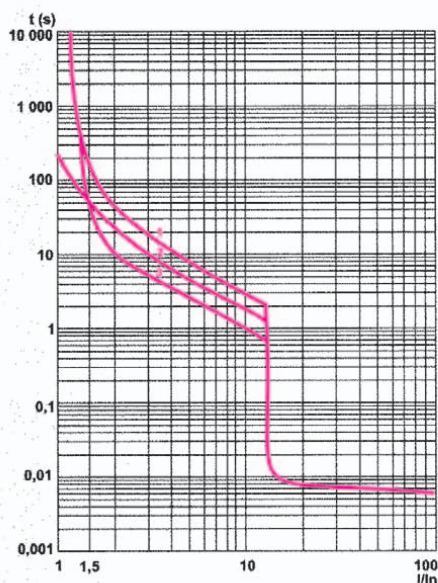

Type number	Rated capacity of three-phase motor in AC-3 category					Magnetic segment current (A)	Thermal protection adjustment range (A)	Thermal current I _{the} TM2-E (A)	Packing/Box (pcs)	Catalogue number
	220V 230V	400V 410V	440V	500V	690V					
TM2-E01	-	-	-	-	-	1.5	0.1 - 0.16	0.16	1 / 50	48001
TM2-E02	-	0.06	0.06	-	-	2.4	0.16 - 0.25	0.25	1 / 50	48002
TM2-E03	0.06	0.09	0.09	-	-	5.0	0.25 - 0.40	0.40	1 / 50	48003
TM2-E04	-	0.12	0.18	-	0.37	8.0	0.40 - 0.63	0.63	1 / 50	48004
TM2-E05	0.09	0.25	0.25	0.37	0.55	13.0	0.63 - 1.00	1	1 / 50	48005
TM2-E06	0.18	0.37	0.37	0.37	0.75	22.5	1 - 1.60	1.6	1 / 50	48006
TM2-E07	0.37	0.75	0.75	1.10	1.50	33.5	1.6 - 2.50	2.5	1 / 50	48007
TM2-E08	0.55	1.10	1.50	1.50	2.20	51.0	2.5 - 4.00	4	1 / 50	48008
TM2-E10	1.10	2.20	2.20	3.00	4.00	78.0	4 - 6.30	6.3	1 / 50	48010
TM2-E14	1.50	3.00	4.00	4.00	5.50	138	6 - 10.0	9	1 / 50	48014
TM2-E16	2.20	5.50	5.50	7.50	9.00	170	9 - 14.0	13	1 / 50	48016
TM2-E20	4.00	7.50	7.50	9.00	15.0	223	13 - 18.0	17	1 / 50	48020
TM2-E21	5.50	9.00	11.0	11.0	18.5	327	17 - 23.0	21	1 / 50	48021
TM2-E22	5.50	11.0	11.0	15.0	22.0	327	20 - 25.0	23	1 / 50	48022
TM2-E32	7.50	15.0	15.0	18.5	22.0	416	24 - 32.0	24	1 / 50	48032
TM3-E40	11.0	18.5	22.0	25.0	33.0	480	25 - 40.0	32	1 / 15	48040
TM3-E63	15.0	30.0	33.0	40.0	55.0	550	40 - 63.0	50	1 / 15	48063
TM3-E80	22.0	40.0	45.0	55.0	63.0	665.5	56 - 80.0	64	1 / 15	48080



Documents corresponding to the product:

Standard EN 60947-1
 EN 60 947-2; EN 60947-4-1
 The products are in accordance with the directives of EC "Low voltage directives (LVD) no 73/23 EEC" and "Electromagnetic Compatibility Directives (EMC) no. 89/336 EEC".

For increasing the effectiveness of the thermomagnetic breakers TM 2-Exx operation, they can be supplied with auxiliary devices, designed for widening the practice range and improving the technical characteristics of the breakers.

Voltage release (VR) for TM 2

The release is designed to switch off the thermomagnetic breaker when the controlling voltage falls under breaking level 0.55 to 0.7 UN and does not allow switching on of the breaker unless the voltage is over 0.85 Un.

Functions:

- switching off the breaker at power supply voltage fall under 0.55 – 0.7 Un
- does not allow switching on of the breaker when the power supply voltage is under 0.85 Un
- prevents unwarranted secondary start of the breaker at falling off and restoring of the power supply voltage
- protects the motor at lack/lowering of the phase voltage
- used as a protective operating element in control panels of induction motors
- remarkable with high reliability of current characteristics

Mounting:

- * laterally to a breaker
- * At the side of the breaker through special openings

Type	Voltage (V)	Catalogue number
TM2 AU225	230	48099
TM3 AU385	400	48098

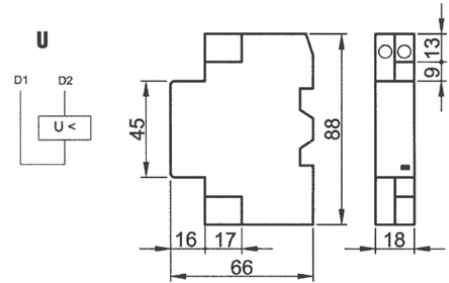

Documents corresponding to the product:
 Standard EN 60529

Watertight box for TM 2-E

Specially designed plastic box with silicon screen for increasing the IP code from dust and moisture to IP 65. Designed for thermal-magnetic circuit breakers of up to 32A

*** Mounting:**

- mounting position: vertical gradient – maximum ± 5°
- mounted to horizontal surfaces (walls) with bolts
- the breaker TM2 Exx is fixed inside of it on rail
- * Plastic: wear resistance of UV rays and non-flammable (self-extinguishing material)

Type	Catalogue number
TM2 E	8083

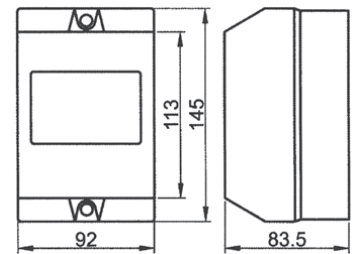

Auxiliary contact block TM2 AE11

It is designed to switch on operational systems or signalization. Designed with one NO and one NC contact. It changes the position of its contacts according to the position of the breaker (switched on/off) to which it is mounted.

*** Mounting:**

- laterally to a breaker TM2-Exx
- * Plastic: wear resistance of UV rays and non-flammable (self-extinguishing material)
- * Ambient temperature: -10°C + 60°C
- * Altitude: up to 2000m

Type	Catalogue number
TM2 AE11	48912

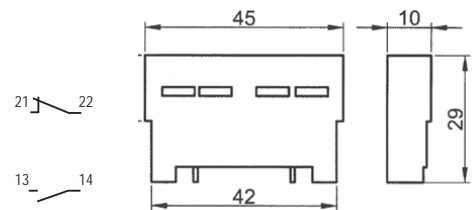

Auxiliary contact block TM2 AN11

It is designed to switch on operational circuits or signalization. It is designed with one NO and one NC contact. It changes the position of its contacts according to the position of the breaker (switched on/off) to which it is mounted.

*** Mounting:**

- laterally to a breaker TM2-Exx
- more than 5 auxiliary contact blocks can be mounted
- * Plastic: wear resistance of UV rays and non-flammable (self-extinguishing material)
- * Ambient temperature: -10°C + 60°C
- * Altitude: up to 2000m

Type	Catalogue number
TM2 AN11	48911
TM3 AN11	48913

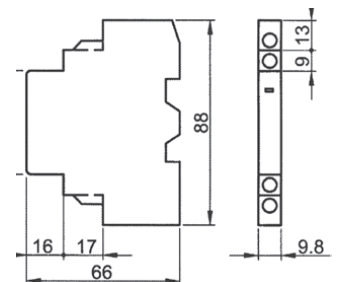

Starters for direct start



Documents corresponding to the product:

Standard EN 60947-1
EN 60947-4-1

The products are in accordance with the directives of EC "Low voltage directives (LVD) no 73/23 EEC" and "Electromagnetic Compatibility Directives (EMC) no. 89/336 EEC".

The electromagnetic starters LT 5 Dxx series are devices designed for remote control, direct control and protection of induction motors or other electrical consumers. They are a combination of contactors LT 1 Dxx series and thermal protection LT 2 Exx fabric cabled. The starters are offered on the market in metal or plastic boxes with the corresponding IP code from dust and moisture. At mounting there should be provided protection of the device from short circuit through breakers or disconnectors. If necessary, at client's order the fabric mounted thermal protection in the pneumatic starter can be substituted. The choice of a suitable protection prevents motor's operation at unusual temperature conditions and guarantees maximum constant operation, increases the effectiveness and prolongs the term of exploitation.

Functions:

- switching on/off alternating current consumers
- does not allow secondary unwarranted switching on of the starter at transitory lowering of the voltage
- protects the motor from overload in the range of the corresponding thermal protection
- remarkable with high reliability of current characteristics

Technical data:

- * Rated voltage of the controlling voltage: 230/400V AC; 50/60 Hz
- Note: In case you need different controlling coils voltage of the starters you can turn to our regional representatives.
- * Rated operating voltage: 690V
- * Rated operating current range: from 7 to 93 A AC
- * insulation voltage: 690V
- * Surge voltage wear resistance: ≥ 60000 V
- * Joining terminal: screw terminal
- * Little power consumption and small dimensions
- * Connecting:
 - flexible or rigid conductors with or without cable terminal for joining to the consumer and section according to the motor power
 - two by two inlets/outlets supplied with orifices for the cables
- * Possibility for range adjustment of the protection activating
- * IP code: IP 44
- * Possibility for operation at higher frequency
- * Mounting:
 - mounting to a flat surface (wall) with bolts/screws
 - mounting position: vertical gradient – maximum $\pm 5^\circ$
- * Plastic: wear resistance of UV rays and non-flammable (self-extinguishing material)
- * Metal corpus: corrosion-proof coating
- * Ambient temperature: $-10^\circ\text{C} + 60^\circ\text{C}$
- * Altitude: up to 2000m

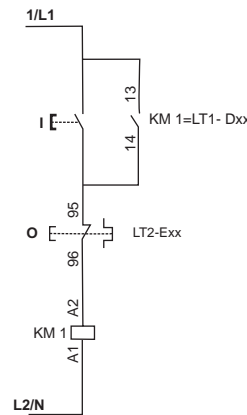
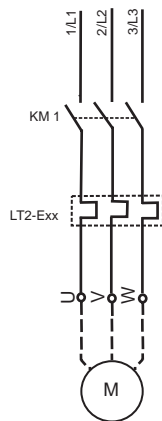

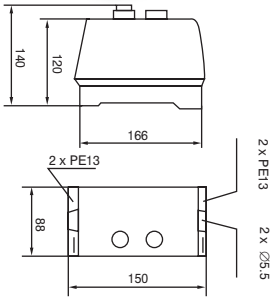
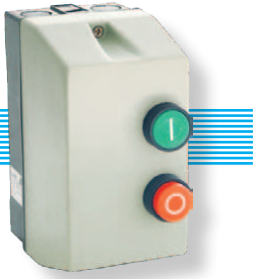

Type	Rated capacity of motors 50/60Hz AC-3 category			Rated current (A)	Thermal relay adjustment range	Coil voltage (V)	Packing/Box (pcs)	Catalogue number
	220V 230V	380V 400V	415V 440V					
LT5 D093	2.2	4.0	4.0	9	7 .. 10A	230	1 / 16	43091
						400	1 / 16	43092
LT5 D123	3.0	5.5	5.5	12	9 .. 13A	230	1 / 16	43121
						400	1 / 16	43122
LT5 D185	4.0	7.5	9.0	18	12 .. 18A	230	1 / 16	43181
						400	1 / 16	43182

Note: Under request the thermal relay will be replaced

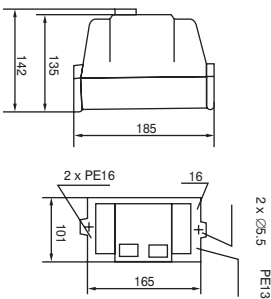
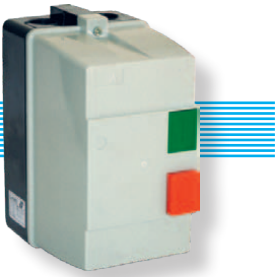

Type	Rated capacity of motors 50/60Hz AC-3 category			Rated current (A)	Thermal relay adjustment range	Coil voltage (V)	Packing/Box (pcs)	Catalogue number
	220V 230V	380V 400V	415V 440V					
LT5 D255	5.5	11	11	25	17 .. 25A	230	1 / 16	43251
						400	1 / 16	43252
LT5 D325	7.5	15	15	32	23 .. 32A	230	1 / 16	43321
						400	1 / 16	43322

Note: Under request the thermal relay will be replaced

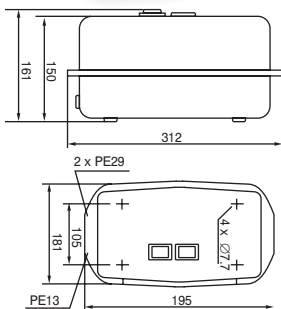

Type	Rated capacity of motors 50/60Hz AC-3 category			Rated current (A)	Thermal relay adjustment range	Coil voltage (V)	Packing/Box (pcs)	Catalogue number
	220V 230V	380V 400V	415V 440V					
LT5 D405	11.0	18.5	22	40	30 .. 40A	230	1/6	43401
						400	1/6	43402
LT5 D655	18.5	30.0	37	65	48 .. 65A	230	1/6	43651
						400	1/6	43652
LT5 D955	25.0	45.0	45	95	80 .. 93A	230	1/6	43951
						400	1/6	43952

Note: Under request the thermal relay will be replaced

“Star/delta” starter



Documents corresponding to the product:

Standard EN 60947-1
EN 60947-4-1

The products are in accordance with the directives of EC “Low voltage directives (LVD) no 73/23 EEC” and “Electromagnetic Compatibility Directives (EMC) no. 89/336 EEC”.

The electromagnetic starters LT 3 Dxx series are devices designed for remote control, direct control and protection of induction motors coiled and operating according to a starter scheme “star/delta”. They are a combination of three contactors LT 1 Dxx series, time relay and a set of buttons “start” and “stop” fabric cabled. They provide the easy motor unwinding giving possibility for setting the time for unwinding in “star” as the time for switching between “star” and “delta” is fixed to 0.5 seconds.

The starters are offered on the market in two types:

- closed type – metal boxes providing the corresponding IP code from dust and moisture (IP 54) as at mounting there should be provided protection of the device from short circuit through breakers or disconnectors
- open type – for mounting in distribution boxes as at mounting there should be provided protection of the device from short circuit through breakers or disconnectors

The starters are offered on the market without mounted thermal protection which is purchased separately according to the motor capacity. The choice of a suitable protection prevents motor’s operation at unusual temperature conditions and guarantees maximum constant operation, increases the effectiveness and prolongs the term of exploitation.

If necessary, at client’s order the power supply operating voltage of the pneumatic starter can be changed.

Functions:

- switching on/off alternating current three phase motors operating according to a scheme “star - delta”
- does not allow secondary unwarranted switching on of the starter at transitory lowering of the voltage
- protects the motor from overload in the range of the corresponding thermal protection
- indication of the operating condition through a valve indicator
- possibility for mounting of additional contacts (for the open type)
- remarkable with high reliability of current characteristics

Technical data:

* Rated voltage of the controlling voltage: 400V AC; 50/60 Hz

Note: In case you need different controlling coils voltage of the starters you can turn to our regional representatives.

* Rated operating voltage: 690V

* Rated operating current range: from 7 to 93A AC

* insulation voltage: >690V

* Surge voltage wear resistance: ≥6000V

* Joining terminal: screw terminal

* Little power consumption and small dimensions

* Connecting:

- flexible or rigid conductors with or without cable terminal for joining to the consumer and section according to the motor power
- three by three inlets/outlets supplied with orifices for the cables

* Possibility for operation at higher frequency

* Protection degree: IP54

* Mounting:

- mounting to a flat surface (wall) with bolts/screws
- mounting position: vertical gradient – maximum ± 5°

* Plastic: wear resistance of UV rays and non-flammable (self-extinguishing material)

* The metal body is covered with corrosion-proof paint

* Ambient temperature: -10°C + 60°C

* Altitude: up to 2000m

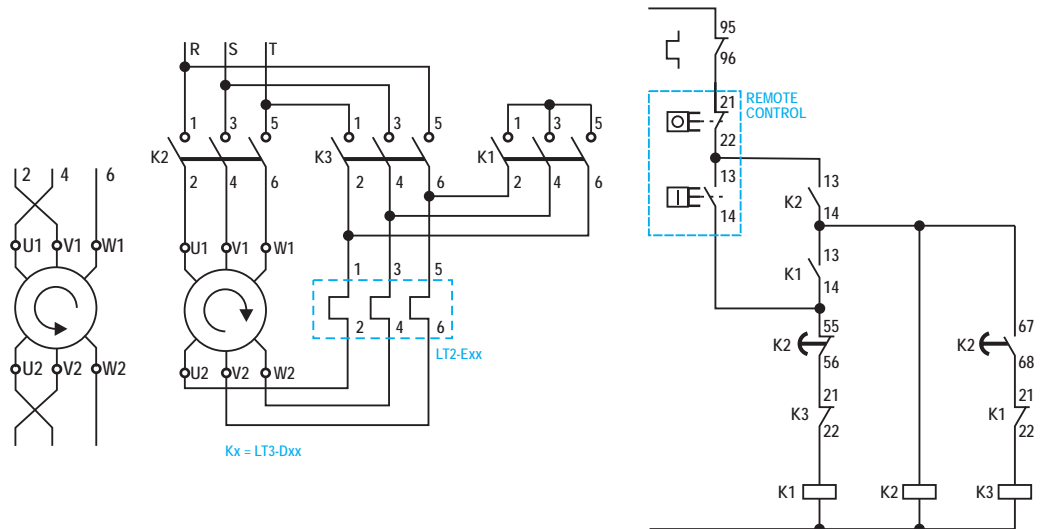

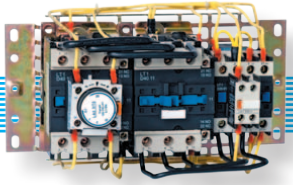

Type designation (without a box)	Overall dimensions (mm)		
	height	width	depth
LT3-D25A	135	170	160
LT3-D32A	135	170	160
LT3-D40A	150	285	190
LT3-D65A	150	285	190
LT3-D95A	150	310	190

Type designation (without a box)	Rated capacity (kW)				Rated current (A)	Coil voltage (V AC)	Packing/Box (pcs)	Catalogue number
	220V 230V	380V 400V	415V	440V				
LT3-D25A	11	15	15	15	25	400	1 / 6	43253
LT3-D32A	15	18.5	18.5	18.5	32	400	1 / 6	43323
LT3-D40A	18.5	22	22	22	40	400	1 / 4	43403
LT3-D65A	30	55	55	55	65	400	1 / 4	43653
LT3-D95A	37	75	75	75	95	400	1 / 4	43953

Note: It is necessary that thermal protection with suitable range is mounted to protect the controlled motor.
The shown values of magnetic starters are for normal regimes for motor control, for hard operation regimes are chosen starters which correspond to the current rating of the motor.

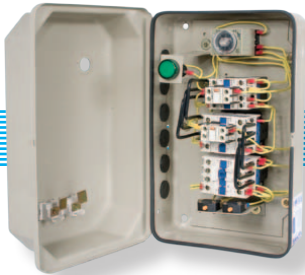

Type designation (without a box)	Overall dimensions (mm)		
	height	width	depth
LT 3 - B - D25A	370	240	160
LT 3 - B - D32A	370	240	160
LT 3 - B - D40A	470	265	160
LT 3 - B - D65A	470	265	160
LT 3 - B - D95A	470	265	160

Type designation (without a box)	Rated capacity (kW)				Rated current (A)	Coil voltage (V AC)	Packing/Box (pcs)	Catalogue number
	220V 230V	380V 400V	415V	440V				
LT 3 - B - D25A	11	15	15	15	25	400	1 / 4	43254
LT 3 - B - D32A	15	18.5	18.5	18.5	32	400	1 / 4	43255
LT 3 - B - D40A	18.5	22	22	22	40	400	1 / 2	43256
LT 3 - B - D65A	30	55	55	55	65	400	1 / 4	43257
LT 3 - B - D95A	37	75	75	75	95	400	1 / 2	43258

Note: It is necessary that thermal protection with suitable range is mounted to protect the controlled motor.
The shown values of magnetic starters are for normal regimes for motor control, for hard operation regimes are chosen starters which correspond to the current rating of the motor.

Reverse starters



Documents corresponding to the product:

Standard EN 60947-1
EN 60947-4-1

The products are in accordance with the directives of EC "Low voltage directives (LVD) no 73/23 EEC" and "Electromagnetic Compatibility Directives (EMC) no. 89/336 EEC".

The electromagnetic starters LT4 Dxx series are devices used for direct start, reverse start and protection of induction motors with short connected rotor. They are a combination of two contactors LT1 Dxx series supplied with two buttons "start" and one "stop" fabric cabled. They provide the unwinding of the motor in one of the directions with possibility for pushing the button "stop" and giving command from the other "start" for changing the motor winding direction. The two contactors are mechanically blocked and do not allow simultaneous start in both winding directions. The starters are offered – closed type in metal boxes providing the corresponding IP code from dust and moisture (IP54) as at mounting there should be provided protection of the device from short circuit through breakers or disconnectors. The starters are offered with mounted thermal protection which can be substituted according to the motor power. The choice of a suitable protection prevents motor's operation at unusual temperature conditions and guarantees maximum constant operation, increases the effectiveness and prolongs the term of exploitation.

If necessary, at order the power supply operating voltage of the pneumatic starter can be changed.

Functions:

- switching on alternating current three phase motors in one winding direction, switching off and change of the winding direction at giving a signal
- does not allow secondary unwarranted switching on of the starter at transitory lowering of the voltage
- protects the motor from overload in the range of the corresponding thermal protection
- remarkable with high reliability of current characteristics

Technical data:

* Rated voltage of the controlling voltage: 400V AC; 50/60 Hz

Note: In case you need different controlling coils voltage of the starters you can turn to our regional representatives.

* Rated operating voltage: 690V

* Rated operating current range: from 7 to 93 A AC

* insulation voltage: 690V

* Surge voltage wear resistance: ≥6000V

* Joining terminal: screw terminal

* Little power consumption and small dimensions

* Connecting:

- flexible or rigid conductors with or without cable terminal for joining to the consumer and section according to the motor power

- three by three inlets/outlets supplied with orifices for the cables

* Possibility for operation at higher frequency

* IP code: IP 44

* Mounting:

- mounting to a flat surface (wall) with bolts/screws

- mounting position: vertical gradient – maximum ± 5°

* Plastic: wear resistance of UV rays and non-flammable (self-extinguishing material)

* The metal body is covered with corrosion-proof paint

* Ambient temperature: -10°C + 60°C

* Altitude: up to 2000m

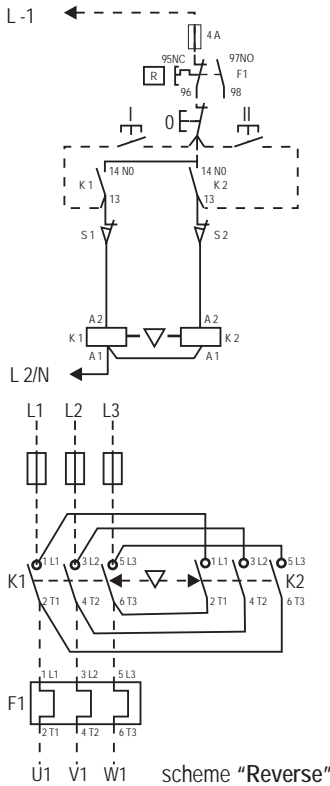

Type designation (with a box)	Rated capacity (kW)				Overall dimensions (mm)			Rated current (A)	Coil voltage (V AC)	Packing/Box (pcs)	Catalogue number
	220V 230V	380V 400V	415V	440V	height	width	depth				
LT 4 - B - D25A	11.0	15.0	15.0	15.0	240	240	160	25	400	1 / 8	43001
LT 4 - B - D32A	15.0	18.5	18.5	18.5	240	240	160	32	400	1 / 4	43002
LT 4 - B - D40A	18.5	22.0	22.0	22.0	270	265	160	40	400	1 / 2	43003
LT 4 - B - D65A	30.0	55.0	55.0	55.0	270	265	160	65	400	1 / 4	43004
LT 4 - B - D95A	37.0	75.0	75.0	75.0	270	265	160	95	400	1 / 4	43005
LT 4 - B - D25A	11.0	15.0	15.0	15.0	240	240	160	25	230	1 / 4	43006
LT 4 - B - D32A	15.0	18.5	18.5	18.5	240	240	160	32	230	1 / 4	43007
LT 4 - B - D40A	18.5	22.0	22.0	22.0	270	265	160	40	230	1 / 4	43008
LT 4 - B - D65A	30.0	55.0	55.0	55.0	270	265	160	65	230	1 / 4	43009
LT 4 - B - D95A	37.0	75.0	75.0	75.0	270	265	160	95	230	1 / 4	43010



Documents corresponding to the product:

Standard EN60898-1

EN 60947-2

The products are in accordance with the directives of EC "Low voltage directives (LVD) no 73/23 EEC" and "Electromagnetic Compatibility Directives (EMC) no. 89/336 EEC".

Frequency inverters are designed to control three-phase induction motors with short-circuited rotor. They provide for the implementation of some control laws, thus becoming an indispensable part of the control systems for conveyors and packaging machines, pumps, air conditioning systems, etc. The ELM 1000 inverter provides the so-called no-sensor control, V/f control and impulse control while the output load can reach up to 150% within 60 seconds. It features easy definition of curves and easy parameters setting of inverter through the use of control panel buttons. The inverter can auto calibrate according to the motor power, i.e. if the inverter is connected to a motor with power different from that set by the inverter manufacturer, it automatically adjusts its programmable parameters to suit the motor parameters.

Functions:

- rotation speed increase – automatic and manual
- sliding compensation: from 0 to 20%
- no-sensor control of the motor
- adjustment of the V/F control curve – linear or quadratic
- energy saving through automatic optimization of the V/F curve
- PID control law implementation option
- omission of resonance frequencies
- JOG function
- 'counter' function
- automatic restart option in case of power supply failure
- fifteen speed degrees control option
- control choice from the control panel; external or COM terminal
- frequency control from the control panel, external potentiometer by current or by voltage
- auto-calibration in accordance with the switched motor
- incoming signals on clockwise or counter-clockwise rotation, multi-step control, restart, etc.
- outgoing discrete control signal 24V
- outgoing analogue control signal 0 – 10V
- DC brake in static mode
- dynamic braking with external braking resistor – used in inert electric motor load
- output voltage adjustment option
- activation of output safety functions option
- electronic motor protection

Technical features:

* Rated working voltage: 230/400V AC; 50 Hz

* Permissible working voltage deviation: $\pm 10\%$

* Unbalance of phases: < 3%

* Frequency fluctuation: < 5%

* Output frequency: 0 – 400 Hz

* Output voltage: from 0 to U_{bx} max

* Overload capacity:

- constant: up to 110%

- momentary: up to 150%

* Precision of output frequency adjustment: 0.1%

* Type of connection:

- the connection of the inverter to the power supply should always be done through a circuit breaker of the MCB or MCCB type

- connection of consumer to power terminals: through conductors suitable for the power

- connection of control circuits: flexible conductor up to 1.5 mm²

Note: It is not recommendable to mount contactors or other commutation devices between the frequency inverter and the motor, except as described in the product passport.

* Mounting:

- mounting to a flat surface by means of bolts

- mounting position – vertical gradient maximum $\pm 5^\circ$

Note: When more than one inverter is mounted in a board, it is recommendable to mount them side by side and when this is not possible, the appropriate cooling conditions should be provided.

* Plastic: UV-rays resistant and fire resistant (self-extinguishing material)

* Ambient temperature: -10° to 60° C

* Altitude : up to 2000 m

* Function enhancement option: through the inclusion of additional modules

Type of sign

ELM1000- G -0150 T3 C

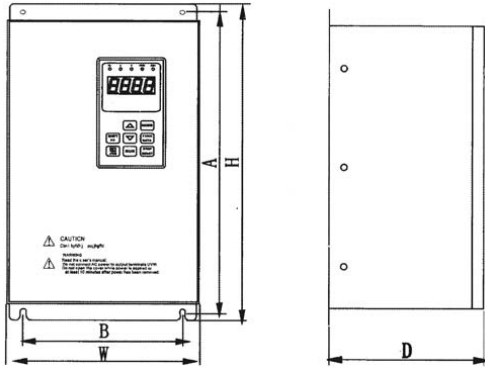
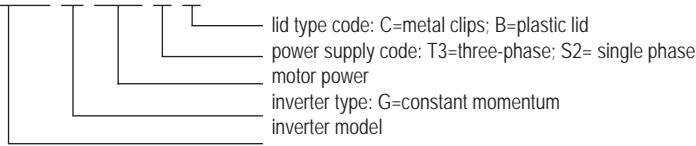

Type	Overall dimensions (mm)					
	H	W	A	B	D	d
ELM1000-G0007S2B	150	105	139	94	120	Ø4
ELM1000-G0015S2B	170	125	160	114	140	Ø5
ELM1000-G0022S2B	170	125	160	114	140	Ø5
ELM1000-G0007T3B	170	125	160	114	140	Ø5
ELM1000-G0015T3B	170	125	160	114	140	Ø5
ELM1000-G0022T3B	170	125	160	114	140	Ø5
ELM1000-G0037T3B	250	162	233	145	150	Ø6
ELM1000-G0040T3B	250	162	233	145	150	Ø6
ELM1000-G0055T3B	300	200	282	182	160	Ø6
ELM1000-G0075T3B	300	200	282	182	160	Ø6
ELM1000-G0110T3C	340	225	322	160	220	Ø6
ELM1000-G0150T3C	380	230	362	186	225	Ø6

Type	Input voltage (V)	Maximum output power (kW)	Maximum current output (A)	Packing/Box (pcs)	Catalogue number
ELM1000-G0007S2B	230	0.75	4.5	1 / 4	423107M
ELM1000-G0015S2B	230	1.5	7	1 / 4	423115M
ELM1000-G0022S2B	230	2.2	9	1 / 4	423122M
ELM1000-G0007T3B	400	0.75	2	1 / 4	423307M
ELM1000-G0015T3B	400	1.5	4	1 / 4	423315M
ELM1000-G0022T3B	400	2.2	6.5	1 / 4	423322M
ELM1000-G0037T3B	400	3.7	8	1 / 1	423337M
ELM1000-G0040T3B	400	4.0	9	1 / 1	423340M
ELM1000-G0055T3B	400	5.5	12	1 / 1	423355M
ELM1000-G0075T3B	400	7.5	17	1 / 1	423375M
ELM1000-G0110T3C	400	11	23	1 / 1	423391M
ELM1000-G0150T3C	400	15	32	1 / 1	423392M

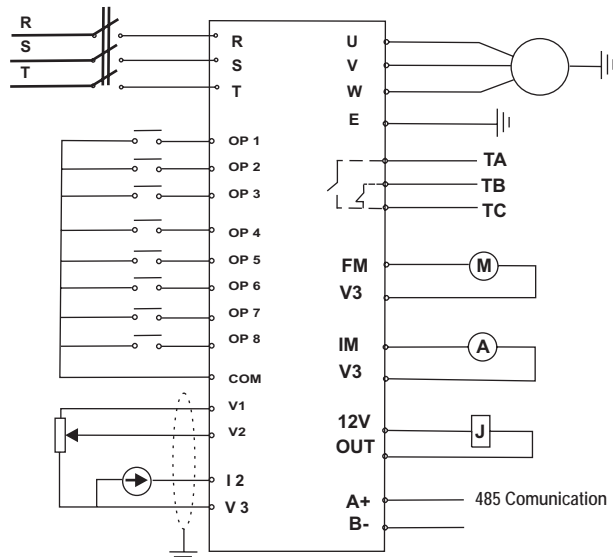

Stopping equipment

Brake resistor and brake element – used when stopping time is little or load inertia moment is huge. Inverters up to 15W are offered with built in brake element but for consumers with high requirements to stopping, there are brake resistors as an outer module for additional mounting to the brake module.

Functions:

- increasing of the brake moment
- providing a quick stop of the motor

Technical data:

- * Rated operating voltage: 230/400V; 50Hz
- * Admissible diversion of the rated voltage: ±10%
- * Disbalance of the phases: <3%
- * Connecting:

- connecting to the inverter through suitable connecting conductors according to the given scheme

*** Mounting:**

- to a metal surface/frame near the inverter
- necessity for enough space for the normal cooling of the module
- take precautionary measures to prevent the access to the electrical connections

Connecting scheme of the auxiliary elements

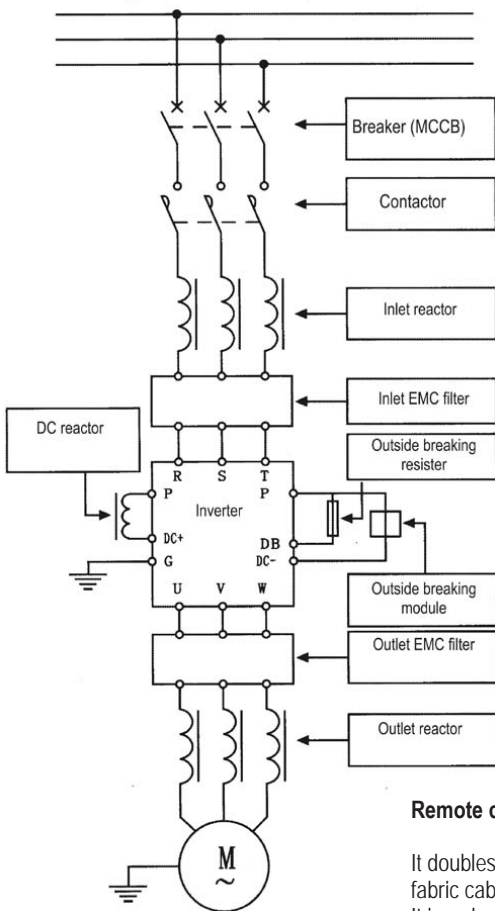

Connecting scheme of a brake resistor

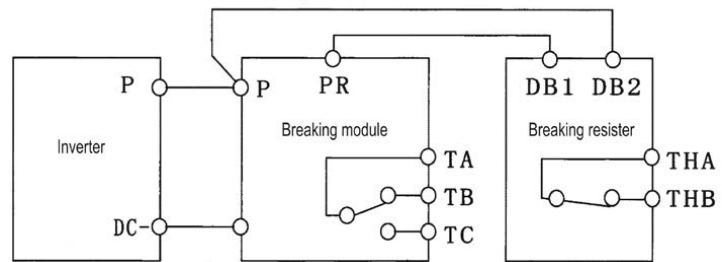

Inverter type	Input voltage (V)	Breaking module	Break resistor admissible value for inverter type	Packing/Box (pcs)	Catalogue number
EL xxx-G0007S2	230	embedded	80W/200Ω	1	422202
EL xxx-G0015S2	230	embedded	160W/100Ω	1	422204
EL xxx-G0022S2	230	embedded	300W/70Ω	1	422205
EL xxx-G0007T4	400	embedded	80W/750Ω	1	422206
EL xxx-G0015T4	400	embedded	160W/400Ω	1	422207
EL xxx-G0022T4	400	embedded	300W/250Ω	1	422208
EL xxx-G0037T4	400	embedded	400W/150Ω	1	422209
EL xxx-G0040T4	400	embedded	400W/150Ω	1	422210
EL xxx-G0055T4	400	embedded	600W/100Ω	1	422211
EL xxx-G0075T4	400	embedded	800W/75Ω	1	422212
EL xxx-G0110T4	400	embedded	1000W/50Ω	1	422213
EL xxx-G0150T4	400	embedded	1500W/40Ω	1	422214

Remote control (Extension of the control panel)

It doubles the control panel and serves for control of the inverter from a distance. It represents the inverter panel fabric cabled with cables with different length – 1.0; 1.5; 2.0; 5 and 10m.

It is ordered as a separate position in addition to the standard equipment of the inverter.

Inverter type	Cable length	Type designation	Packing/Box (pcs)	Catalogue number
EL xxx-G0007S2	2 m	UPM 2	1	422UPM2
EL xxx-G0015S2	2 m	UPM 2	1	422UPM2
EL xxx-G0007T4	2 m	UPM 2	1	422UPM2
EL xxx-G0015T4	2 m	UPM 2	1	422UPM2
EL xxx-G0022T4	2 m	UPM 2	1	422UPM2
EL xxx-G0037T4	2 m	UPM 2	1	422UPM2
EL xxx-G0055T4	2 m	UPM 2	1	422UPM2
EL xxx-G0075T4	2 m	UPM 2	1	422UPM2
EL xxx-G0110T4	2 m	UPG 2	1	422UPG2
EL xxx-G0150T4	2 m	UPG 2	1	422UPG2



Documents corresponding to the product:

Standard EN60947-4-2
EN 60947-1

The products are in accordance with the directives of EC "Low voltage directives (LVD) no 73/23 EEC" and "Electromagnetic Compatibility Directives (EMC) no. 89/336 EEC".

Soft starters are designed to control the start of three-phase induction motors with short-circuited rotor. A number of motor control issues are avoided through them, and namely: prolonged start moments, auto-ignition of motor, there is no need of stardelta switching, auto-transformer switching, resistant switching, etc. The ELM 2500 soft starter pertains to the AC53b type of starters as per the standard requirements and it provides rotation of motor and once the operation mode is set, a shunt contactor of the LT 1 D/F series is switched to control motor operation as the soft starter is not designed to control motors in a set mode. Under a stop command in accordance with the selected control scheme, the soft starter can or can not be included in shutting the motor down.

Functions:

1. System functions
 - over-voltage protection – motor will switch off when power supply exceeds the preset limits
 - overload protection – protects the motor from overloading
 - phase loss protection
 - temperature overload protection
2. Control functions
 - output faults
 - motor faults diagnostics
 - keyboard or outward control
 - delayed start option
 - faults memory

Technical features:

- * Rated working voltage: 230/400V AC; 50 Hz
- * Permissible working voltage deviation: $\pm 10\%$
- * Unbalance of phases: $< 3\%$
- * Frequency fluctuation: $< 5\%$
- * Obligatory bypass contactor installation
- * Mounting :

- mounting to a flat surface through bolts
- mounting position – vertical gradient maximum $\pm 5^\circ$

Note: When more than one soft starter is mounted in a board, it is recommendable to mount them side by side and when this is not possible, the appropriate cooling conditions should be provided.

- * Plastic: UV-rays resistant and fire resistant (self-extinguishing material)
- * Altitude : up to 2000 m

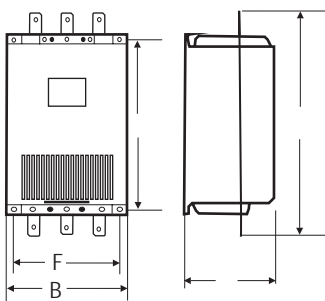

Type	Overall dimensions (mm)					
	A	B	C	E	F	d
EL M25015	250	153	162	219	140	Ø6
EL M25022	250	153	162	219	140	Ø6
EL M25037	250	153	162	219	140	Ø6
EL M25045	250	153	162	219	140	Ø6
EL M25055	250	153	162	219	140	Ø6
EL M25075	510	260	194	389	232	Ø8

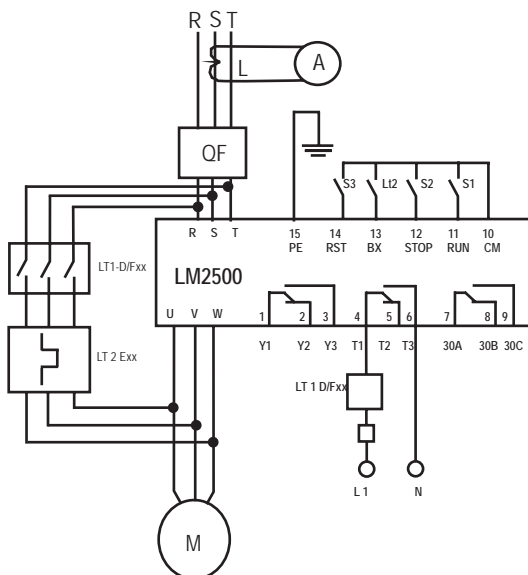

Type	Power of motor (kW)	Rated current (A)	Type of bypass contactor	Section of power supply conductors	Packing/Box (pcs)	Catalogue number
EL M25015	15	30	LT 1-D 50	10	1 / 1	42225015
EL M25022	22	45	LT 1-D 50	10	1 / 1	42225022
EL M25037	37	76	LT 1-D 80	16	1 / 1	42225037
EL M25045	45	90	LT 1-D 95	25	1 / 1	42225045
EL M25055	55	110	LT 1-F 115	25	1 / 1	42225055
EL M25075	75	150	LT 1-F 150	35	1 / 1	42225075

TIMERS, RELAYS AND DISPLAYING DEVICES

TIMERS AND DISPLAY

EL[®]MARK

TIMERS, RELAYS AND DISPLAYING DEVICES



TIMERS, RELAYS
AND DISPLAYING DEVICES

Programmable digital one-channel timer TE 15A



Type	Packing/Box (pcs)	Catalogue number
TE 15 A	1 / 100	50036

The timer is manufactured under the CMOS technology with a quartz minicontroller which makes it reliable for operation. The timer is adjusted for DIN-rail mounting. It can memorize up to eight ON/OFF programs (ON/OFF cycles). Each program setting is done through the push buttons. Programming starts with selection of the days of the week (you can choose among a whole week cycle, work days cycle, weekend cycle, or a specific day of the week); then the cycle start time and end time are set. If you have selected work days cycle, then the program will start and stop at the set times each work day of the week. This is one ON/OFF program. Where necessary, other programs can be memorized up to the limit of eight possible programs. If you continue setting new programs the first memorized program will be deleted. The minimal interval for cycle programming is 1 minute.

Technical data:

- * Display: LCD
- * Power supply voltage: 230V; 50Hz
- * Operations: 8 switching ON/OFF
- * Time deviation: <2s (at 25°C)
- * Battery for programme storing: up to 15 days
- * Power consumption: <5VA
- * Switched on indicator
- * Electrical wear resistance: 10⁵ cycles
- * Mechanical wear resistance: 10⁷ cycles
- * Operating temperature: -10°C - +40°C
- * Humidity: 35 – 85%RH
- * Number of contacts: 1NO + 1NC
- * Commutating capacity:
 - active load: up to 6A
 - inductive load: up to 2.5

Mounting:

- * DIN-rail

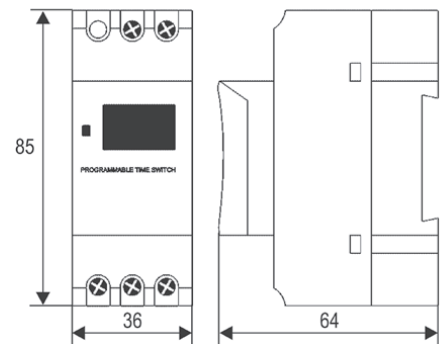

Programmable digital one-channel timer TE 15B



Type	Packing/Box (pcs)	Catalogue number
TE 15 B	1 / 100	50101

The timer is manufactured under the CMOS technology with a quartz minicontroller which makes it reliable for operation. The timer is adjusted for DIN-rail mounting. It can memorize up to six ON/OFF programs (ON/OFF cycles). Each program setting is done through the push buttons. Programming starts with selection of the days of the week (you can choose among a whole week cycle, work days cycle, weekend cycle, or a specific day of the week); then the cycle start time and end time are set. If you have selected work days cycle, then the program will start and stop at the set times each work day of the week. This is one ON/OFF program. Where necessary, other programs can be memorized up to the limit of eight possible programs. If you continue setting new programs the first memorized program will be deleted. The minimal interval for cycle programming is 1 minute. There is possibility for automatic correction of the time according to the seasonal sun variations.

Technical data:

- * Display: LCD
- * Automatic adjustment of the current time (time correction winter/summer)
- * Power supply voltage: 230V; 50Hz
- * Operations: 6 switching ON/OFF
- * Time deviation: <2s (at 25°C)
- * Battery for programme storing: up to 15 days
- * Power consumption: <5VA
- * Switched on indicator
- * Electrical wear resistance: 10⁵ cycles
- * Mechanical wear resistance: 10⁷ cycles
- * Operating temperature: -10 - +40°C
- * Humidity: 35 – 85%RH
- * Number of contacts: 1NO + 1NC
- * Commutating capacity:
 - active load: up to 6A
 - inductive load: up to 2.5

Mounting:

- * DIN-rail

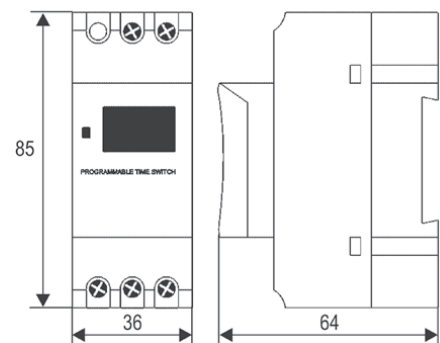



Type	Packing/Box (pcs)	Catalogue number
TE 20	1 / 92	50100

Programmable digital one-channel timer TE 20

The timer is manufactured under the CMOS technology with a quartz minicontroller which makes it reliable for operation. The timer is adjusted for DIN-rail mounting. It is possible to adjust forty-eight ON/OFF cycles. Each program setting is done through selection of the cycle start and end time with the push buttons. When a program is on, the time cycle is indicated as a dimmed out section on the dial. For example, if you start a 2-hour program the 2-hour portion between On and Off times on the dial becomes dark. The minimal interval for cycle programming is 15 minutes. The battery allows programme storing at lack of power supply.

Technical data:

- * Power supply voltage: 230V; 50Hz
- * Time deviation: <2s (at 25°C)
- * Battery for programme storing and operation: up to 150 hours
- * Power consumption: <5VA
- * Switched on indicator
- * Electrical wear resistance: 10⁵ cycles
- * Mechanical wear resistance: 10⁷ cycles
- * Operating temperature: -10 - +40°C
- * Humidity: 35 – 85%RH
- * Number of contacts: 1NO + 1NC
- * Li-Ion battery: 150h
- * Commutating capacity:
 - active load: up to 16A
- * Weight: 120g

Mounting:

- * DIN-rail

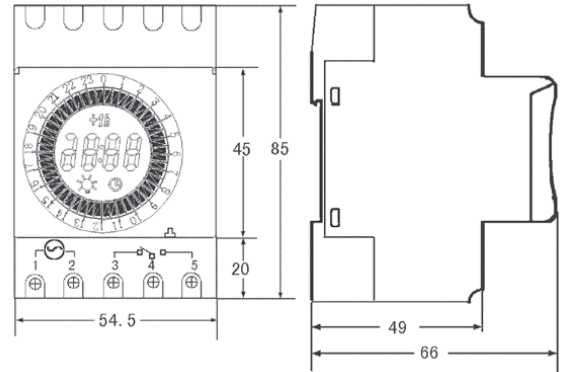

Type	Packing/Box (pcs)	Catalogue number
TE 18	1 / 200	35005

Tariff switching clock (timer) TE 18

The timer is adjusted for DIN-rail mounting. It is used for switching on tariff lighting in housing buildings and switching off after the adjusted time. Easy to adjust time intervals, mounting and conducting. Reliable to use.

Technical data:

- * Power supply voltage: 230V; 50Hz
- * Adjustment range: 0.5 to 20 min
- * Power consumption: <5VA
- * Operating temperature: -10-+55°C
- * Humidity: 45 – 85%RH
- * Number of contacts: 1NO
- * Commutating capacity:
 - active load: up to 16A
 - inductive load: up to 10 A
- * Weight: 75g

Mounting:

- * DIN-rail



Type	Packing/Box (pcs)	Catalogue number
TE19	1 / 200	50102

Time relay "star/delta" TE 19

The time relay is manufactured under the most modern methods of qualitative and reliable materials. The timer is adjusted for DIN-rail mounting. It is used to provide reliable and safe time hold at "star/delta" starters and it is used for setting fixed time intervals. Programming is done through selection of the time unit (seconds or minutes) and rate (x 0.1 or x1) by the slide switches, and then selection of a value from the timer knob (from 0 to 10). Whenever timer circuit receives a signal, it executes the set cycle and then stops until a new signal is available. It gives possibility for time adjustment for motor unwinding in star up to 600s and time change to delta according to the consumer's need.

Technical data:

- * Power supply voltage: 230V; 50Hz
- * Adjustment range for operation in star: 1 to 600 seconds
- * Repetition accuracy: ±5% from the whole scale
- * Adjustment accuracy: ±5% from the whole scale
- * Zeroing time: <0.5s
- * Power consumption: <5VA
- * Electrical wear resistance: 100 000 cycles
- * Mechanical wear resistance: 1 000 000 cycles
- * Operating temperature: -10-+55°C
- * Humidity: 45 – 85%RH
- * Commutating capacity: up to 5A

Indication:

- at operation in "star": red indication
- at operation in "delta": green indication

Weight: 150g

Mounting:

- * DIN-rail

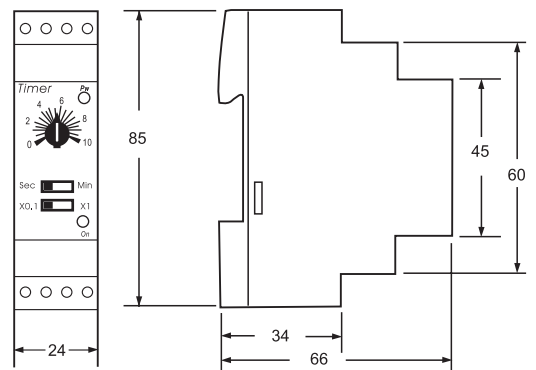



Type	Packing/Box (pcs)	Catalogue number
TE8A - 1a	1 / 75	50113
TE8A - 2a	1 / 75	50114



Type	Packing/Box (pcs)	Catalogue number
EP510	8 / 160	50300



Type	Packing/Box (pcs)	Catalogue number
TE6B	1 / 100	50104

Timer TE8A – 1a, TE8A – 2a

The timer is manufactured under the most modern technology CMOS with a quartz minicontroller which makes it precise, qualitative and reliable. It has a built in battery which allows operation of the timers without charging up to 150 hours. The timer is adjusted for DIN-rail mounting. Timer programming is done through selection of the operational day(s) of the week, followed by selection of the start time and end time. You may choose out of ten modes (one for each day of the week, one for the work days, one for the weekends and one for the whole week). When setting the time, you should start first with the hours and then continue with the minutes.

TE8A - 1a - Up to eight programs can be memorized. The on/off time resolution is 1 minute.

TE8A - 2a - It has two operating channels, each of which can adjust four programmes for a day or a week with minimal interval of 1 minute for switching on and off.

Indication on LCD display with high resolution and showing the time in hours, minutes and seconds.

Technical data:

- * Power supply voltage: 230V; 50Hz
- * Power consumption: <5VA
- * Electrical wear resistance: 10⁷ cycles
- * Mechanical wear resistance: 10⁵ cycles
- * Operating temperature: -10°C - +55°C
- * Temperature of storage: up to 70C
- * Humidity: 45 – 85%RH
- * Commutating capacity: up to 16A
- * Two outlet relays
- * Li-Ion battery: 150h
- * Weight: 150g

Mounting:

- * DIN-rail

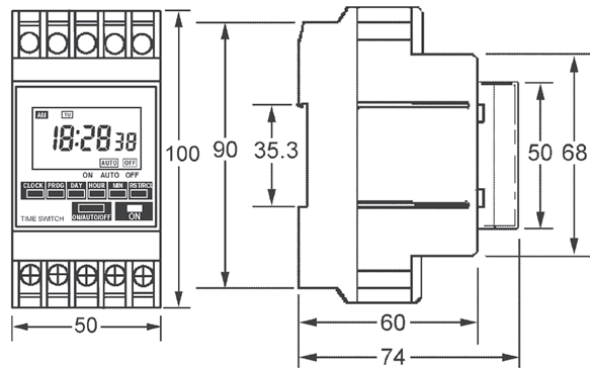

Impulse relay

Impulse relays allow circuit remote control. They can be operated manually, remotely, from several control points, or by impulses. Impulse relays are most frequently used for the control of lighting circuits in various public places with multiple control points.

Technical data:

- * Control voltage: 230V
- * Rated current of the power circuit: 16A
- * Electrical endurance: 200000 cycles
- * Maximum switching frequency: 5 operations/minute
- * Impulse duration: 50ms

Connection:

- * tunnel terminals

Timer TE6B

The timer is manufactured under the most modern technology CMOS with a quartz minicontroller which makes it precise, qualitative and reliable. The timer is modulated to be mounted on the front panel of boards. The direction of operation is adjusted – direct or reverse. There is possibility to adjust the time range from 0.01 second to 99 hours 59 minutes, possibility for correction of the set values during operation. Indication on LCD display with high resolution and showing the time in hours, minutes and seconds.

Technical data:

- * Power supply voltage: 230V; 50Hz
- * Possibility for choice of operating range:
 - from 0.01 second to 99.99 seconds
 - from 1 second to 99.59 minutes
 - from 1 minute to 99.59 hours
- * Error: <0.01% ±0.05s
- * Minimal duration of the input pulse: 20ms
- * Power consumption: <5VA
- * Electrical wear resistance: 10⁷ cycles
- * Mechanical wear resistance: 10⁵ cycles
- * Operating temperature: -10-+55°C
- * Temperature of storage: up to 70°C
- * Humidity: 45 – 85%RH
- * Commutating capacity at active load: 3A
- * Weight: 300g

Mounting:

- * on the front panel of the board

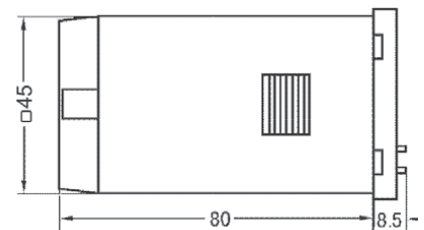

Programmable timers



Timer TE48S-S

The timer is manufactured under the most modern technology CMOS with a quartz minicontroller which makes it precise, qualitative and reliable. The timer is modulated to be mounted on the front panel of boards. The direction of operation is adjusted – direct or reverse. It represents two separate operating channels, each of which can operate independently with time range adjustment from 1 second to 99 minutes. Possibility for correction of the set values during operation. First, select the time unit (seconds or minutes) and then set the time. Depending on the timer coupling, it can be used as a cyclic timer relay, i.e. it initially counts the first time set, then counts the second time set, then starts counting over the first time again, etc. until a stop signal is received. In another mode, the timer can count the set time and stop until a new signal is received to count the next cycle. Indication on LCD display with high resolution and showing the time in hours, minutes and seconds.

Technical data:

- * Power supply voltage: 230V; 50Hz
- * Admissible variation of the input voltage: 85-110%U
- * Possibility for choice of operating range:
 - from 1 to 99 seconds
 - from 1 minute to 99 minutes
- * Error: <math><0.01\% \pm 0.05s</math>
- * Minimal duration of the input pulse: 20ms
- * Power consumption: <math><5VA</math>
- * Electrical wear resistance: 10^7 cycles
- * Mechanical wear resistance: 10^5 cycles
- * Operating temperature: -10-+55°C
- * Temperature of storage: up to 70°C
- * Humidity: 45 – 85%RH
- * Commutating capacity at load: 3A
- * Weight: 300g

Mounting:

- * on the front panel of the board

Type	Packing/Box (pcs)	Catalogue number
TE48S-S	84	50105

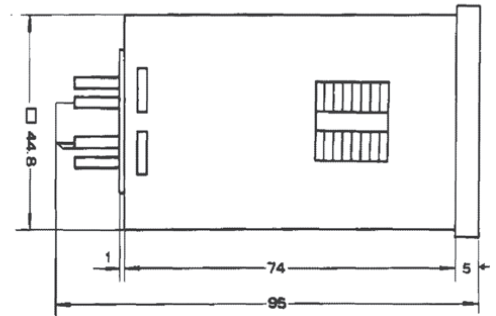
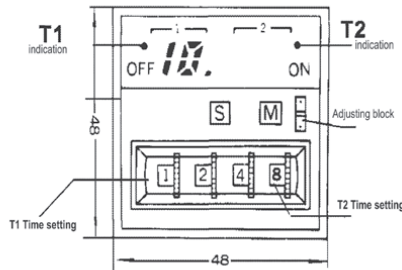
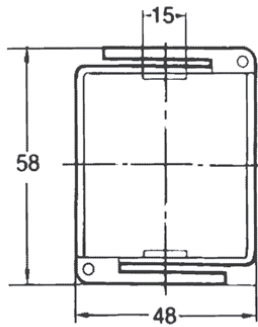

Timer TE 19M

Timer is developed using modern technologies from quality and reliable materials and is adapted for mounting on DIN rail. It is used for providing time intervals in eight time programs, which are assigned by combinations of the keys. There is an option for it to operate in time ranges (assigned by the keys K4, K5, K6): seconds, minutes or hours depending on the necessity of the user. Power contact up to 3A.

Technical characteristics:

- * Input voltage: 230V; 50Hz
- * Range of setting: from 0.6 sec to 100 hours
- * Accuracy of setting: $\pm 5\%$ from the whole scale
- * Time for nullifying: <math><0.5</math> seconds
- * Consumed capacity: <math><5VA</math>
- * Electrical endurance (number of cycles): 100 000 cycles
- * Mechanical endurance (number of cycles): 1 000 000 cycles
- * Operation temperature: -10 - +55°C
- * Humidity: 45 - 85%RH
- * Computing option: up to 5A
- * Indication:
 - on power supply: red indication
 - on operational output relay: green indication
- * Weight: 150 gr.
- * Time functions: according to the programming guide

Mounting method:

- * DIN rail



Type	Packing/Box (pcs)	Catalogue number
TE 19M	1 / 200	50102M

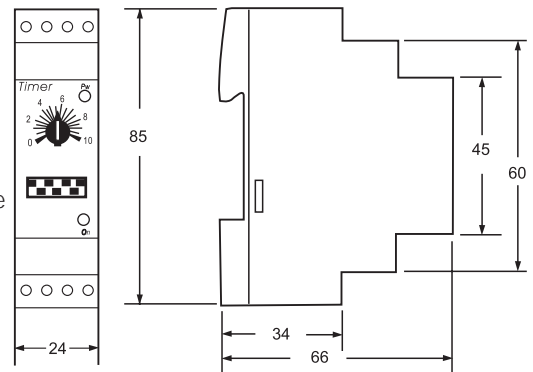



Documents corresponding to the product:
Standard EN 61010-1

Type	Packing/Box (pcs)	Catalogue number
CE2J	1 / 45	50111

Universal digital counter CE2J

The device is manufactured under the modern technology CMOS which allows high speed of counting and high counting reliability. It has a built in battery which allows data storing for more than 10 years. It is supplied with a digital display with black lighting digits, providing excellent visibility at different lighting. The counter is to be mounted on the front panel of the boards. It is used for impulse sequence counting with accumulation or deduction. There is possibility for relay outlet operation at reaching beforehand set value, and also a possibility for changing the position of the decimal point.

Technical data:

- * Display: LCD
- * Power supply voltage: 230V; 50Hz
- * Counting range: 0 - 99999
- * Counting speed: 30/3k cps
- * Zeroing: outside impulse
- * Battery for programme storing: up to 10 years
- * Power consumption: <5VA
- * Operating temperature: -10-+40°C
- * Humidity: 35 – 85%RH
- * Commutating capacity: relay outlet with active load: up to 3A
- * Weight: 250g

Mounting:

- * on the front panel
- * opening with dimensions: 45x45

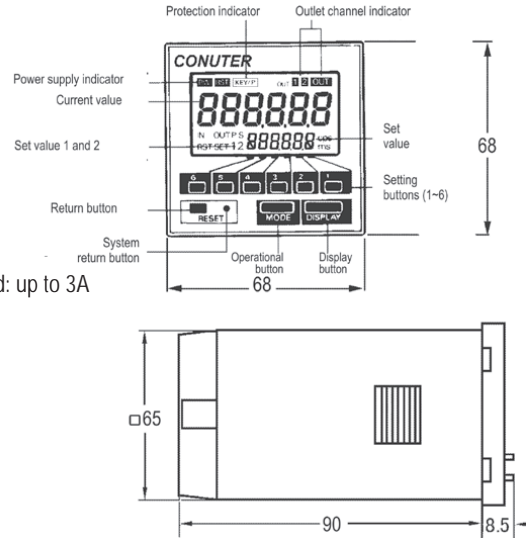

Documents corresponding to the product:
Standard EN 61010-1

Type	Packing/Box (pcs)	Catalogue number
CE10J	1 / 45	50120

Combined digital counter/timer CE10J

The device is for front mounting in the board. It can be used as a counter or timer choosing a definite combination from keys. It is manufactured under the modern technology CMOS which allows high speed of counting, precision at operation as a timer and high reliability. It has a built in battery which allows data storing for more than 10 years. It is supplied with a digital display providing excellent visibility at different lighting. It is used for impulse sequence counting with accumulation or deduction. There is possibility for relay outlet operation at reaching beforehand set value, and also a possibility for changing the position of the decimal point.

Technical data:

- * Display: LCD
- * Power supply voltage: 230V; 50Hz
- * Counting range: 0 – 999
- * Timer range: 0.01 – 99h99min
- * Counting speed: 30/500 cps
- * Zeroing: outside impulse
- * Battery for programme storing: up to 10 years
- * Power consumption: <3VA
- * Mechanical wear resistance: 107 cycles
- * Operating temperature: -5-+40°C
- * Humidity: 35 – 85%RH
- * Commutating capacity: relay outlet with active load: up to 3A
- * Weight: 120g

Mounting:

- * on the front panel
- * opening with dimensions: 45x45

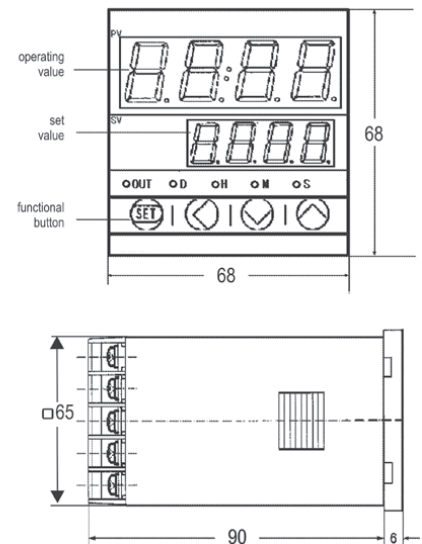



Documents corresponding to the product: EN 61010-1

Type	Packing/Box (pcs)	Catalogue number
CE15J	1 / 100	50112

Total digital counter CE15J

The device is to be mounted on DIN-rail. It is used as an impulse counter with no outside power supply. For that purpose there is a Li battery built in the device which provides data storing and operation of the device for 5 years. It has eight digital lighting display providing excellent visibility at different lighting. It is used for impulse sequence counting with accumulation.

Technical data:

- * Display: LCD
- * Power supply voltage: built in battery
- * Inlet signal: 100-230V AC/DC
- * Counting accuracy: <0.002%
- * Data storing battery: up to 5 years
- * Operating temperature: -5-+40°C
- * Humidity: 35 – 85%RH
- * Weight: 120g

Mounting:

- * DIN-rail

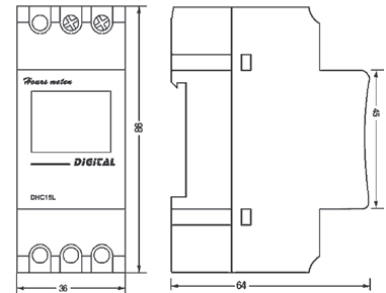

Documents corresponding to the product: EN 61010-1

Type	Packing/Box (pcs)	Catalogue number
CE15L	1 / 100	50115

Total digital counter CE15L

The device is to be mounted on DIN-rail. It is used as a time impulse counter with no outside power supply. For that purpose there is a Li battery built in the device which provides data storing and operation of the device for 5 years. It has eight digital lighting display providing excellent visibility at different lighting. It is used for time impulse sequence counting with accumulation. It displays the operated time.

Technical data:

- * Display: LCD
- * Power supply voltage: built in battery
- * Inlet signal: 100-230V AC/DC
- * Counting accuracy: <0.002%
- * Battery for data storing: up to 5 years
- * Operating temperature: -5-+40°C
- * Humidity: 35 – 85%RH
- * Weight: 120g

Mounting:

- * DIN-rail

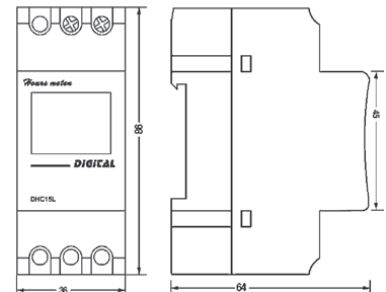

Documents corresponding to the product: EN 61010-1

Type	Packing/Box (pcs)	Catalogue number
EK - RSTB	1 / 200	50103

Phase sequence indicator EK - RSTB

The device is to be mounted on DIN-rail. It is used for control and indication of the presence, sequence and quality of the phases. The device indicates the following fault:

- lack of one or several phases;
- change in the sequence of the phases;
- lowering of the power supplying voltage: under 10%;
- increasing of the power supplying voltage: over 10%;
- phase asymmetry of the power supplying voltage: ±10%

In the presence of one of the conditions above a relay starts operating in the device which breaks the controlling circuit.

The time between fault indication and outlet relay switching on can be adjusted in order to prevent unwilling stops at very short breaks. When the voltage is back to normal limits, the device receives energy (indication lights) according to the hysteresic values. At phase sequence fault the device operates immediately.

Technical data:

- * Power supply voltage: 400V; 50Hz
- * Possibility for operation range adjustment: 0.1 – 10 seconds
- * Possibility for working range adjustment: from 300 to 480 V
- * Electrical wear resistance: 1 000 000 cycles
- * Mechanical wear resistance: 10 000 000 cycles
- * Indication:
 - green LED – indication for a change in the condition
 - red LED - failure
- * Operating temperature: -5-+40°C
- * Humidity: 35 – 85%RH
- * Weight: 120g

Mounting:

- * DIN-rail

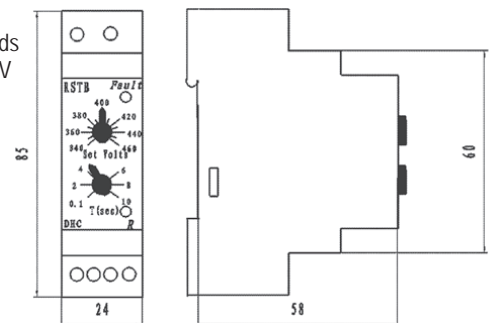



Documents corresponding to the product: EN 60947-5-1; EN 61810

Industrial Relays and Bases

Devices intended for construction of automation and signalling boards. They are mainly used for command transfer towards the executive mechanisms. Currents of comparatively heavy values enabling the direct control of industrial executive mechanisms are commuted in comparatively small sizes. The contact surfaces are made from silver-coated electrolytic copper. The entire contact system is closed within a lid of colourless fire-proof plastic with a test-button installed to it. The base provides a safe electric connection of the conductors of the electric installation and the relays and is used to install the relay to the DIN busbar.

Technical Characteristics:

- * Supply voltage: from 12 to 230V AC, 50 Hz and from 12 to 110V DC
- * Acceptable deviation of the supply voltage: 85 - 110% Un
- * Rated current of the sockets: 10A AC
- * Electrical endurance: 1 000 000 cycles
- * Isolation resistance: 500 mΩ / min (500V)
- * Impulse tension resistance: 2000V, 50Hz
- * Dielectric strength: 1000V AC/1 min
- * Turn-out time: 25ms
- * Working temperature: -5 - + 65°C
- * Humidity: 35 - 85% RH

Method of installation:

- * on a DIN rail by means of a socket

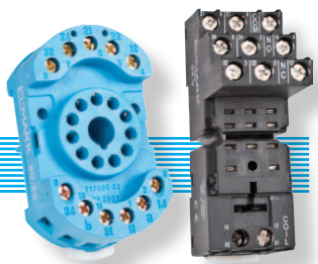
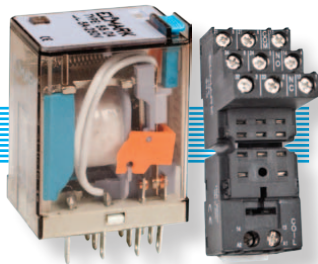
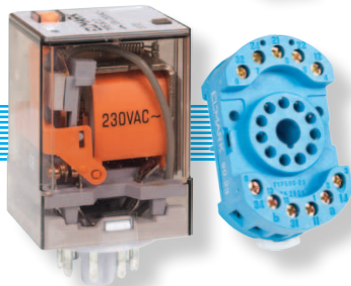

Relay type	Voltage of the coil (V)	Socket type	Resistance of the coil (Ω)	Number of contacts	Packing/Box (pcs)	Catalogue number
ELM - 14FC	12 VDC	ELM-08A	270	NO+NC	100 / 1000	57141
ELM - 14FC	24 VDC	ELM-08A	1080	NO+NC	100 / 1000	57142
ELM - 14FC	48 VDC	ELM-08A	4340	NO+NC	100 / 1000	57143

Relay type	Voltage of the coil (V)	Socket type	Resistance of the coil (Ω)	Number of contacts	Packing/Box (pcs)	Catalogue number
ELM - 60.2	12 VDC	ELM - 90.22	20	2NO+2NC	20 / 300	57601
ELM - 60.2	24 VDC	ELM - 90.22	80	2NO+2NC	20 / 300	57602
ELM - 60.2	48 VDC	ELM - 90.22	320	2NO+2NC	20 / 300	57603
ELM - 60.2	230 VAC	ELM - 90.22	7400	2NO+2NC	20 / 300	57605
ELM - 60.13	12 VDC	ELM - 90.23	20	3NO+3NC	20 / 300	57611
ELM - 60.13	24 VDC	ELM - 90.23	80	3NO+3NC	20 / 300	57612
ELM - 60.13	48 VDC	ELM - 90.23	320	3NO+3NC	20 / 300	57613
ELM - 60.13	110 VAC	ELM - 90.23	1700	3NO+3NC	20 / 300	57614
ELM - 60.13	230 VAC	ELM - 90.23	7400	3NO+3NC	20 / 300	57615

Relay type	Voltage of the coil (V)	Socket type	Resistance of the coil (Ω)	Number of contacts	Packing/Box (pcs)	Catalogue number
ELM - 55.02	12 VDC	ELM - 94.3	42	2NO+2NC	50 / 500	57521
ELM - 55.02	24 VDC	ELM - 94.3	168	2NO+2NC	50 / 500	57522
ELM - 55.02	48 VDC	ELM - 94.3	675	2NO+2NC	50 / 500	57523
ELM - 55.02	230 VAC	ELM - 94.3	14000	2NO+2NC	50 / 500	57525
ELM - 55.04	12 VDC	ELM - 94.4	42	4NO+4NC	50 / 500	57541
ELM - 55.04	24 VDC	ELM - 94.4	168	4NO+4NC	50 / 500	57542
ELM - 55.04	48 VDC	ELM - 94.4	675	4NO+4NC	50 / 500	57543
ELM - 55.04	110 VAC	ELM - 94.4	3500	4NO+4NC	50 / 500	57544
ELM - 55.04	230 VAC	ELM - 94.4	14000	4NO+4NC	50 / 500	57545

Socket type	Dimensions (mm)	Number of terminals (pcs.)	Packing/Box (pcs)	Catalogue number
ELM - 08A	72 x 15	5	20 / 600	57901
ELM - 94.3	67 x 30	11	10 / 240	57902
ELM - 94.4	67 x 30	14	10 / 240	57903
ELM - 90.22	68 x 38	8	10 / 400	57904
ELM - 90.23	68 x 38	11	10 / 400	57905



Documents corresponding to the product: EN 60947-5-1; EN 61810

Industrial Solid State Relays (SSR)

Industrial SSR are intended for mounting in power and control cabinets as an output switch devices with reliable ON/OFF performance. The SSR are based on the CMOS technology. The non-contact electronic switch is optically separated from the input signal by a photoelectric coupler. This allows use of switch currents of up to 50A despite of the devices small overall size. Another important feature of the relay is that output load can be regulated depending on the input signal value. The relay is mainly used to transmit control signals to actuating mechanisms since it can work at comparatively high currents making it possible to directly control actuators. RRS have transparent plastic covers to additionally improve their safety level. The SSR use is connected with considerable heat emissions, so measures must be taken to dispense the excessive thermal energy in the atmosphere. This is achieved through application of specially designed radiators. The correct definition of radiator parameters is of critical importance. It is made by calculating the heat generation capacity with the formula: Heat generation = active load current x 3.0 W/A. The heat removal surface is estimated with the help of the following graphic:

Technical Specifications:

Load/output voltage: 30/400V 50 Hz or SRndrom0 o230/400VDC or the solid state voltage regulators

Rated output current: from 10A to 60A

Insulating voltage: 1000 MQ /min (500V)

Impulse voltage stability: 2000V, 50Hz

Dielectric Strength: < 2500VAC / 1 min

Leakage current: <2mA

Turn-on time: <10ms

Operating temperature: -5°C + 65°C

Relative Humidity: 35 - 85%RH

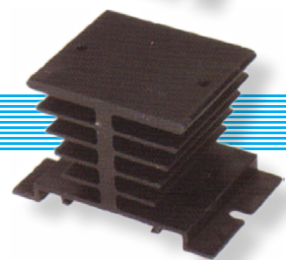
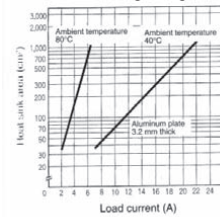

Type	Relay Type	Control Voltage (V)	Output Voltage (V)	Number of phases	Output Current (A)	Packing/Box (pcs)	Catalogue number
ZG3NC - 2 - 10B	SSR	3-32VDC	230VAC	1	10	10 / 100	57710
ZG3NC - 2 - 20B	SSR	3-32VDC	230VAC	1	20	10 / 100	57720
ZG3NC - 2 - 25B	SSR	3-32VDC	230VAC	1	25	10 / 100	57725
ZG3NC - 2 - 40B	SSR	3-32VDC	230VAC	1	40	10 / 100	57740
ZG3NC - 2 - 60B	SSR	3-32VDC	230VAC	1	60	10 / 100	57760
ZG3NC - 3 - 10B	SSR	3-32VDC	400VAC	2	10	10 / 100	57713
ZG3NC - 3 - 20B	SSR	3-32VDC	400VAC	2	20	10 / 100	57723
ZG3NC - 3 - 25B	SSR	3-32VDC	400VAC	2	25	10 / 100	57735
ZG3NC - 3 - 40B	SSR	3-32VDC	400VAC	2	40	10 / 100	57743
ZG3NC - 3 - 60B	SSR	3-32VDC	400VAC	2	60	10 / 100	57763

Type	Relay Type	Control Voltage (V)	Output Voltage (V)	Number of phases	Output Current (A)	Packing/Box (pcs)	Catalogue number
ZG1NC - 2 - 10D	SS voltage regulator	1-10VDC	0-230VAC	1	10	10 / 100	57810
ZG1NC - 2 - 20D	SS voltage regulator	1-10VDC	0-230VAC	1	20	10 / 100	57820
ZG1NC - 2 - 25D	SS voltage regulator	1-10VDC	0-230VAC	1	25	10 / 100	57825
ZG1NC - 2 - 40D	SS voltage regulator	1-10VDC	0-230VAC	1	40	10 / 100	57840
ZG1NC - 3 - 10D	SS voltage regulator	1-10VDC	0-400VAC	2	10	10 / 100	57813
ZG1NC - 3 - 20D	SS voltage regulator	1-10VDC	0-400VAC	2	20	10 / 100	57823
ZG1NC - 3 - 25D	SS voltage regulator	1-10VDC	0-400VAC	2	25	10 / 100	57835
ZG1NC - 3 - 40D	SS voltage regulator	1-10VDC	0-400VAC	2	40	10 / 100	57843

Type	Relay Type	Control Voltage (V)	Output Voltage (V)	Number of phases	Output Current (A)	Packing/Box (pcs)	Catalogue number
ZG33 - 3 - 10B	SSR	3-32VDC	400VAC	3	10	1 / 30	57831
ZG33 - 3 - 20B	SSR	3-32VDC	400VAC	3	20	1 / 30	57832
ZG33 - 3 - 25B	SSR	3-32VDC	400VAC	3	25	1 / 30	57833
ZG 33 - 3 - 40B	SSR	3-32VDC	400VAC	3	40	1 / 30	57834

Note: The relay output must be supplied with a varistor to ensure its over-voltage protection, whenever RRS is used to control inductive loads.

Type of Radiator	Overall Dimensions (L/W/H)	Approximate Load (A)	Packing/Box (pcs)	Catalogue number
QW-A 50	60 x 50 x 50	15	1 / 50	57906
QW-B 72	72x100x50	20	1 / 50	57907
QW-B 100	100x100x50	25	1 / 50	57908
QW-C 115	115x100x50	40	1 / 50	57909
QW-E 50	150x88x35	75	1 / 40	57910



Documents corresponding to the product: Standard EN 61010-1; EN 60044-1; EN 60044-6

Current measurement transformers MES - xx/xx type

The measurement transformers find application at current measuring, current regulation, systems for current characteristics watching, systems for reactive energy compensation, signaling, etc. They are with x/5 gear ratio as X is the inlet range of the transformer.

Technical data:

- * Maximum operating voltage: 720V; 50Hz
- * Admissible deviation of the operating current: 1.2 x I_n
- * Inlet current: 50 – 1200A
- * Outlet current: 5A
- * Impulse voltage wear resistance: 4000V; 50Hz (1min)
- * Operating temperature: -5+65°C
- * Humidity: 35 – 85%RH
- * Precision class: 0.5

Mounting:

- * Current transformers can be DIN rail mounted;
- * vertically or horizontally to the power supplying rails according to the opening of the transformer
- * Current transformers can be mounted on flat surfaces by use of fixing clamps.

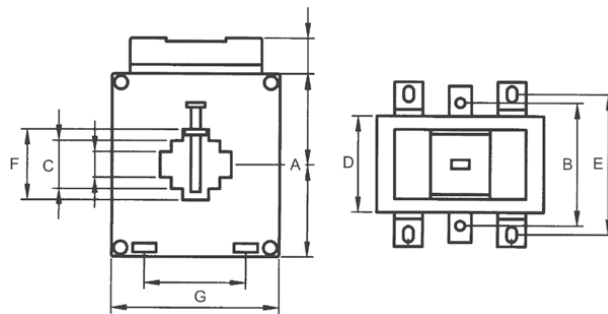

Type	Overall dimensions (mm)						
	A	B	C	D	E	F	G
MES - 75/30	88	52	52	41	77	31	31
MES - 75/40	88	52	52	41	77	41	41
MES - 86/60	117	57	57	184	77	61	61

Type	Range	Precision class	Capacity VA	Weight kg	Packing/Box (pcs)	Catalogue number
MES - 75/30	50/5	0.5	1.5	0.60	1 / 40	45050A
MES - 75/30	75/5	0.5	1.5	0.60	1 / 40	45075A
MES - 75/30	100/5	0.5	1.5	0.60	1 / 40	45103A
MES - 75/30	150/5	0.5	2.5	0.60	1 / 40	45153A

Type	Range	Precision class	Capacity VA	Weight kg	Packing/Box (pcs)	Catalogue number
MES - 75/40	200/5	0.5	5	0.60	1 / 40	45204A
MES - 75/40	250/5	0.5	5	0.60	1 / 40	45254A
MES - 75/40	300/5	0.5	10	0.60	1 / 40	45304A
MES - 75/40	400/5	0.5	10	0.60	1 / 40	45404A
MES - 75/40	500/5	0.5	10	0.60	1 / 40	45504A
MES - 75/40	600/5	0.5	15	0.60	1 / 40	45604A

Type	Range	Precision class	Capacity VA	Weight kg	Packing/Box (pcs)	Catalogue number
MES - 86/60	400/5	0.5	15	0.60	1 / 40	45406A
MES - 86/60	500/5	0.5	15	0.60	1 / 40	45506A
MES - 86/60	600/5	0.5	15	0.60	1 / 40	45606A
MES - 86/60	800/5	0.5	15	0.60	1 / 40	45806A
MES - 86/60	1000/5	0.5	15	0.60	1 / 32	45906A
MES - 86/60	1200/5	0.5	15	0.60	1 / 32	45916A

Current transformers, type CP

Current measuring transformers of duct type. Specially designed to be installed in measuring circuits without removing cables in current measuring circuit. CP Transformers save installation time and decrease installation costs

Technical Specification:

- small size table:
- secondary coil rated current 5A
- rated voltage 720V
- frequency 50Hz
- rated load: up to 30VA
- safety coefficient: $f_s \leq 5$
- accuracy class :0.5; 1
- secondary coil connection: cable shoe terminal

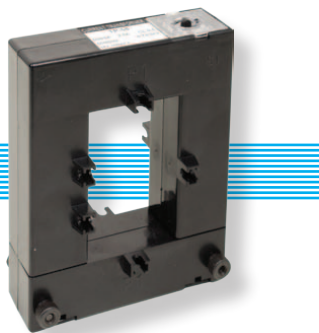

Documents corresponding to the product: Standard EN 60044-1

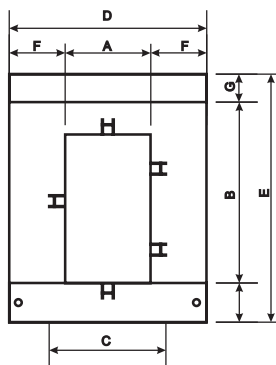

Type	Overall dimensions (mm)						
	A	B	C	D	E	F	G
CP 23	20	30	51	89	111	34	47
CP 58	50	80	78	114	145	32	32
CP 88	80	80	108	144	145	32	32

Type	Range	Precision class	Capacity VA	Weight kg	Packing/Box (pcs)	Catalogue number
CP 23	200/5	1	1,5	0,74	1 / 45	452320
CP 23	250/5	1	1,5	0,74	1 / 45	452325
CP 23	300/5	0,5	1,5	0,74	1 / 45	452330

Type	Range	Precision class	Capacity VA	Weight kg	Packing/Box (pcs)	Catalogue number
CP 58	250/5	0,5	1,5	0,87	1 / 36	455825
CP 58	300/5	0,5	1,5	0,87	1 / 36	455830
CP 58	400/5	0,5	1,5	0,87	1 / 36	455840
CP 58	500/5	0,5	2,5	0,87	1 / 36	455850
CP 58	600/5	0,5	2,5	0,87	1 / 36	455860

Type	Range	Precision class	Capacity VA	Weight kg	Packing/Box (pcs)	Catalogue number
CP 88	400/5	0,5	1,5	1	1 / 20	458840
CP 88	500/5	0,5	1,5	1	1 / 20	458850
CP 88	600/5	0,5	1,5	1	1 / 20	458860
CP 88	750/5	0,5	2,5	1	1 / 20	458875
CP 88	800/5	0,5	2,5	1	1 / 20	458880
CP 88	1000/5	0,5	5	1	1 / 20	458890



Documents corresponding to the product: Standard EN 61010-1

Type	Packing/Box (pcs)	Catalogue number
CD - 701	1	50124

Digital Temperature Controller Type CD - 701

The device is intended for industrial control and monitoring of temperature. It allows monitoring and adjustment of temperatures of up to 1999°C depending on the used sensor – thermocouple or thermoresistor. The device allows programming of the used type of sensor (K (CA) ; J (IC) PT 100, etc.) and the controller working range. It also allows selection of the control algorithm, error adjustment, indication hysteresis curve adjustment and alarm settings. The controller is intended for mounting on control panels. It is user friendly and can be set through the push buttons on the device front panel. The program can be password protected. When operational, the display shows the set temperature and the current temperature.

Technical Specifications:

- * Rated voltage: 230V, 50 Hz
- Permissible voltage deviation: 85 - 110% Un
- Input signal: from thermocouple, thermoresistor or unified signal (4-20mA; 0-10VDC)
- Output: Relay
- Emergency Output: Relay
- Electrical life: 1 000 000 cycles.
- Indication:
 - Green LED – indicates the measured (current) temperature
 - Red LED – indicates the set temperature
- Insulation resistance: 20 MΩ /min (500V)
- Impulse voltage stability: 2000V, 50Hz
- Operating temperature: -5°C + 65°C
- Relative Humidity: 35 - 85%RH
- Mounting:**
 - * on the front panel



Thermocouple and thermo resistance

The thermo-measuring elements are designed for measuring the temperature in the point of contact between the surface (warmed or cooled) and the thermo-element. They are a comparatively cheap and the most wide-spread method for temperature measurement. The thermocouples are produced by accumulating two conductors from a special measuring alloy in one common head. Each of these elements has a specific electromotive voltage at a specific temperature. The temperature measuring is based on the difference in the electromotive powers between the hot and the cool end of the thermocouple, while this difference in the form of voltage of several millivolts is supplied at the input of the thermoregulator, which displays the measured temperature. Each thermocouple is produced and calibrated for measuring of specific temperature ranges depending on the alloys of which it is made. When thermocouples measuring great distances from the thermoregulators are used (more than 15 points), it is obligatory to use compensatory cable corresponding to the type of the thermocouple. The thermo-resistant elements action is based on the capacity of specific alloys, very often Pt100 to change their resistance when the temperature is changed. For each temperature value is specified a value of resistance. This value is supplied at the input of the thermoregulator, which displays the measured temperature.

Each thermoregulator operates with a specific type of thermo-element.

Type of thermo-element	Symbol	Temperature range	Type of catching	Sizes of the head	Size of the free end	Packing/Box (pcs)	Catalogue number
K	WRNT - 01	-15 ÷ 95°C	nut	30 x 35	1m	1 / 300	50K95G
K	WRNT - 01	0 ÷ 400°C	nut	30 x 35	1m	1 / 300	50K40G
K	WRNT - 31	0 ÷ 400°C	Bayonet	30 x 35	0.5m	1 / 200	50K40B
K	WRNT - 13	0 ÷ 400°C	explosion-proof	Ø6	2m	1 / 200	50K40EX
J	WRKT - 01	0 ÷ 400°C	nut	30 x 35	1m	1 / 300	50J40G
J	WRKT - 13	0 ÷ 400°C	explosion-proof	Ø6	2m	1 / 300	50J40EX
Pt100	WZPT - 03	-100 ÷ 250°C	explosion-proof	Ø6	2m	100	50PT95EX
Cu50	WZCT - 03	-50 ÷ 100°C	explosion-proof	Ø6	2m	50	50PT40EX



Documents corresponding to the product: Standard EN 61010-1

Type	Packing/Box (pcs)	Catalogue number
EKDP-15AA	1 / 100	50117A
EKDP-15AD	1 / 100	50117D
EKDP-15VA	1 / 100	50116A
EKDP-15VD	1 / 100	50116D

Digital voltmeter/ammeter EKDP 15 A/V

Digital device adjusted for DIN-rail mounting and offered in two types:

- ammeter
- voltmeter

It is supplied with LCD display where the measurement quantity is displayed with numbers with 3 1/2 size. It has high accuracy of analogue-digital transfer, measurement precision and electromagnetic interference stability. There is possibility for adjustment of the measurement range through built in micro switches. Adjusted to measure constant current (AD,DV) and alternating current (AA,VA) quantities.

Technical data:

- * Power supply voltage: 100 - 240V; 50Hz
 - * Inlet signal:
 - operating as voltmeter: 2 – 700V (the range is adjusted from inside)
 - operating as ammeter: 5 – 2000A (the range is adjusted from inside)
 - Note:** At current range over 5A a current measurement transformer should be used
 - * Consumption: <5A
 - * Impulse voltage wear resistance: 4000V; 50Hz (1min)
 - * Operating temperature: -5+50°C
 - * Humidity: 35 – 85%RH
 - * Precision: 0.5% from the whole scale
 - * Display: LCD
 - * Weight: 150gr
- Mounting:**
- * DIN-rail

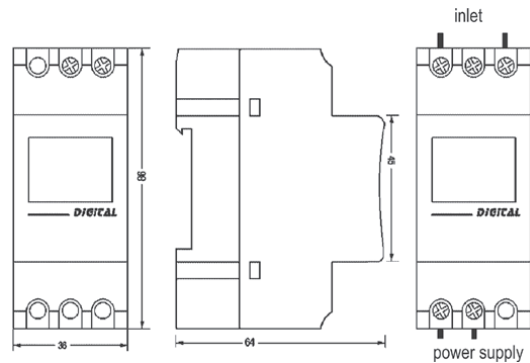

Documents corresponding to the product: Standard EN 61010-1

Type	Packing/Box (pcs)	Catalogue number
EKDP7-AV	1 / 84	50106
EKDP7-AA	1 / 84	50107
EKDP7-DV	1 / 84	50108
EKDP7-DA	1 / 84	50109
EKDP7-HZ	1 / 84	50110

Digital voltmeter/ammeter and frequency meter EKDP7

Digital device adjusted for mounting on the front panel of electrical boards and offered in the following types:

- ammeter:
 - EKDP7 – AA – ammeter for alternating current
 - EKDP7 – DA – ammeter for direct current
- voltmeter:
 - EKDP7 – AV – voltmeter for alternating current
 - EKDP7 – DV – voltmeter for direct current
- EKDP7 – Hz – frequency meter

It is supplied with LCD display where the measurement quantity is displayed with numbers with 3 1/2 size. It has high accuracy of analogue-digital transfer, measurement precision and electromagnetic interference stability. There is possibility for adjustment of the measurement range through built in micro switches. Adjusted to measure direct current and alternating current quantities.

Technical data:

- * Power supply voltage: 100 - 240V; 50Hz
- * Inlet signal:
 - operating as voltmeter: 2 – 700V (the range is adjusted from inside)
 - operating as ammeter: 5 – 2000A (the range is adjusted from inside)
- Note:** For high current range a current measurement transformer should be used for alternating current device and a measurement shunt for direct current.
- * Consumption: <5A
- * Impulse voltage wear resistance: 4000V; 50Hz (1min)
- * Operating temperature: -5+50°C
- * Humidity: 35 – 85%RH
- * Precision: 0.5% from the whole scale
- * Display: LCD
- * Weight: 130gr

Mounting:

- * on the front panel

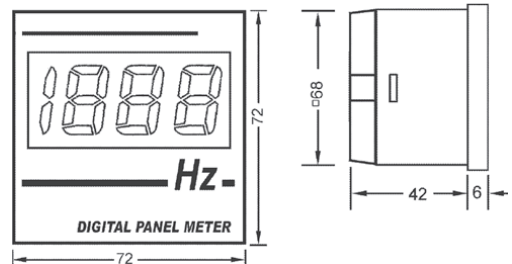



Documents corresponding to the product: Standard IEC 62052-11; IEC 62053-21; IEC 62056-21

DIN Rail Mounted kWh Meters

Electronic single and three phase kWh meters intended for DIN rail mounting and active energy measurement. Meters are suitable for home and commercial applications. They perform direct measurement of the real consumption of electric power and the results are shown on the LCD display. The system doesn't need any additional adjustment or calibration.

The range includes single and multi-tariff models.

Technical Specifications:

- * Direct power consumption measurement: up to 20 (80) A; 50/60Hz
- * Automatic temperature compensation
- * LED phase voltage outage indicator.
- * Indication for wrong cable connection
- * Indication for wrong measurement
- * Accuracy class: 1
- * Number of tariffs: see the table below
- * Meter constant: See the table below



Type	Measuring range	Number of Tariffs	Meter constant (imp/kWh)	Voltage (V)	Overall dimensions (mm) height / width / depth	Packing/Box (pcs)	Catalogue number
DDS - 1Y - 45	5 (45)	1	1000	230	63 / 18 / 118	1 / 25	50214
DDS - 1Y - 100	10 (100)	1	1600	230	65 / 76 / 100	1 / 60	50260
DDS - 3Y 80	20 (80)	1	800	3x230/400	65 / 76 / 100	1	50380



Documents corresponding to the product: Standard IEC 62052-11; IEC 62053-21; IEC 62056-21

PREPAID IC card kWh meter

Electronic single and three phase energy meter for active energy measurement. It can function after recharge the electricity through IC card. Meters are suitable for home and commercial applications. Meter have LCD display to show Total electricity(kWh), Remain kWh, Latest kWh. This meter has infrared and RS 485 communication port.

Technical Specifications:

- * Rated current : up to 5(80)A
- * Frequency: 50Hz
- * Impulse constant: 1000imp/kWh
- * Accuracy class: 1.0
- * Display: LCD 6+2



Type	Measuring range	Number of Tariffs	Meter constant (imp/kWh)	Voltage (V)	Overall dimensions (mm) height / width / depth	Packing/Box (pcs)	Catalogue number
DDS 1YY	5 (60)	1	1000	230	111 / 172 / 55	1	50500
DDS 3YY	5 (80)	1	1000	3*230/380	169 / 220 / 64	1	50550



Programmer for IC card prepaid kWh meter

Catalogue number: 50600



Documents corresponding to the product: Standard EN 60051-1



Analogue (pointer) panel meters SD72 type for build-in

Analogue devices adjusted for mounting on the front panel of electrical boards. Designed for frequency measurement, capacity, alternating or direct voltage and current of the power supply grid, with overall dimensions 72x72mm. They are manufactured on the basis of bridge measurement schemes. There is possibility for display change for the higher scopes of measuring.

Type	Type of the measurement system	Precision class	Range	Note	Packing/Box (pcs)	Catalogue number
amperemeter AC	MEMSI	1.5	0-40A	-	1 / 100	50118
amperemeter AC	MEMSI	1.5	0-100A	current transfer 100/5	1 / 100	654010
amperemeter AC	MEMSI	1.5	0-200A	current transfer 200/5	1 / 100	654020
amperemeter AC	MEMSI	1.5	0-400A	current transfer 400/5	1 / 50	654040
amperemeter AC	MEMSI	1.5	0-600A	current transfer 600/5	1 / 50	654060
amperemeter AC	MEMSI	1.5	0-1000A	current transfer 1000/5	1 / 50	654100
amperemeter AC	MEMSI	1.5	0-1500A	current transfer 1500/5	1 / 50	654150
voltmeter AC*	MEMSI	1.5	0-500V	-	1 / 50	50125
frequency meter**	ME	0.5	45-65Hz	-	1 / 50	50126
cosφ meter	MEMSI	1.5	3P 400V	-	1 / 50	50127
amperemeter DC	MEMC	1.5	0-5A	-	1 / 50	50128
amperemeter DC	MEMC	1.5	0-50A	outer resistor 60mV	1 / 50	50129
voltmeter DC	MEMC	1.5	0-50V	-	1 / 50	50130
voltmeter DC	MEMC	1.5	0-100V	-	1 / 20	50131
wattmeter	MEMSI	1.5	0-3000W 1P240V	-	1 / 25	50132
wattmeter	MEMSI	1.5	0-3000W 3P 3 line	-	1 / 25	50133
wattmeter	MEMSI	1.5	0-3000W 3P 4 line	-	1 / 25	50134

Note: MEMSI - magnetic-electrical movable steel instrument; MEMC – magnetic-electrical movable coil

* Possibility for supplying with voltage transformer X/100V for range expanding

** Possibility for voltage 110V, 230V, 400V

ELEMENTS FOR AUTOMATION, MONITORING AND CONTROL

ELEMENTS FOR AUTOMATION, MONITORING AND CONTROL

EL[®]MARK

ITS FOR
N, MONITORING
OL, MANUFACTURING
ROL



ELEMENTS FOR AUTOMATION,
MONITORING AND CONTROL

The all-purpose limit switches are devices used in automatic systems as a control element. They are used for setting of gearing limits. They are mounted on transport lines, conveyors and other linear progressive motion machines. They feature a vibration-resistant metal shell.

Product conformity documentation:

Standard: EN 60947-1; EN 60947-5-1

All-purpose limit switch – series CSA-xxx

- * Dielectric strength: 1000V AC
- * Insulating resistance: 100mΩ
- * Electrical endurance (number of cycles): 500 000 with active load
- * Mechanical endurance (number of cycles): 1 000 000
- * Gearing speed: 5mm/s to 0.5 m/s
- * Rated voltage: 230V
- * Rated current: up to 10A
- * Protection degree: IP66
- * Cable input: cable gland PG11
- * Section of power supply conductor: up to 2mm²
- * Fastening strength of terminals: 6-8kgf/cm

Type of the contact system

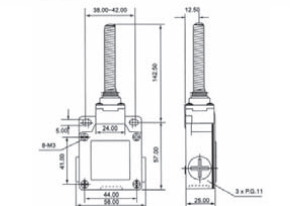
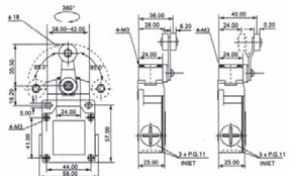
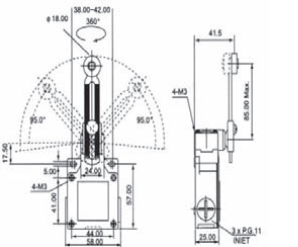
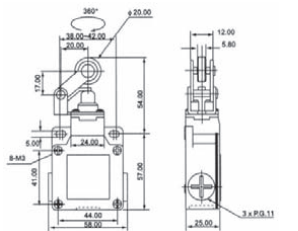
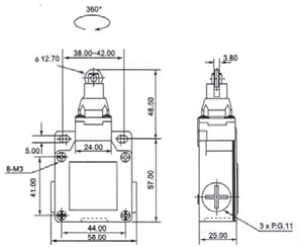
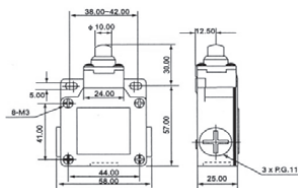
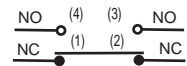

Type	Type of the head	Power of starting	Power of release	Switching position	General movement	Rated current	Packing/Box (pcs)	Catalogue number
CSA - 001	metal cylinder	800g	400g	2.0mm	5.8mm	10A-active 4A-inductive	10 / 90	46A001

Type	Type of the head	Power of starting	Power of release	Switching position	General movement	Rated current	Packing/Box (pcs)	Catalogue number
CSA - 003	cylinder with metal roll	800g	400g	2.0mm	5.8mm	10A-active 4A-inductive	10 / 90	46A003

Type	Type of the head	Power of starting	Power of release	Switching position	General movement	Rated current	Packing/Box (pcs)	Catalogue number
CSA - 012	horizontal lever with metal roll	800g	400g	2.0mm	5.8mm	10A-active 4A-inductive	10 / 90	46A012

Type	Type of the head	Power of starting	Power of release	Switching position	General movement	Rated current	Packing/Box (pcs)	Catalogue number
CSA - 031	adjustable lever with metal roll	400g	100g	22.5°	95°	10A-active 4A-inductive	10 / 80	46A031

Type	Type of the head	Power of starting	Power of release	Switching position	General movement	Rated current	Packing/Box (pcs)	Catalogue number
CSA - 021	lever with metal roll	400g	100g	22.5°	95°	10A-active 4A-inductive	10 / 80	46A021

Type	Type of the head	Power of starting	Power of release	Switching position	General movement	Rated current	Packing/Box (pcs)	Catalogue number
CSA - 081	spring lever	150g	50g	22.5°	50mm	10A-active 4A-inductive	10 / 80	46A081

Limit switches

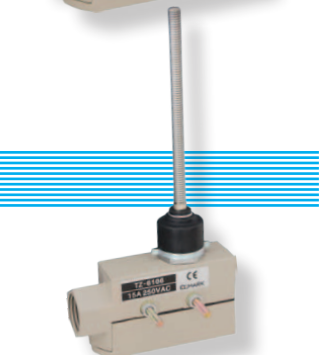

The all-purpose limit switches are installed on transport lines, conveyors and other linear progressive motion machines.

The miniature limit switch is mounted in an aluminum shell, resistant to vibrations, lubricants and water.

Product conformity documentation:

Standard: EN 60947-1; EN 60947-5-1

All-purpose limit switch – series TZ-6xxx

- * Dielectric strength: 1000V AC
- * Insulating resistance: 100mΩ
- * Contact resistance: 15mΩ
- * Electrical endurance (number of cycles): 500 000 with active load
- * Mechanical endurance (number of cycles): 10 000 000
- * Gearing speed: 0.1mm/s to 0.5 m/s
- * Rated voltage: 230V
- * Protection degree: IP65
- * Cable input: cable gland PG11
- * Section of power supply conductor: up to 1.5mm²

Type of the contact system

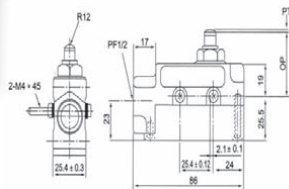
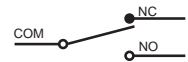

Type	Type of the head	Power of starting	Power of release	Switching position	General movement	Rated current	Packing/Box (pcs)	Catalogue number
TZ-6001	metal cylinder	350g	115g	0.5mm	5.5mm	15A-active 5A-inductive	1 / 50	466001

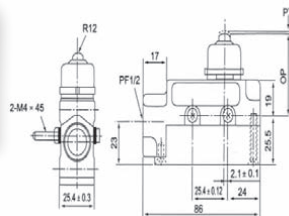

Type	Type of the head	Power of starting	Power of release	Switching position	General movement	Rated current	Packing/Box (pcs)	Catalogue number
TZ - 6101	oil-resistant metal cylinder	800g	240g	2mm	5mm	15A-active 5A-inductive	1 / 50	466101

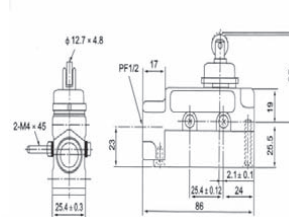

Type	Type of the head	Power of starting	Power of release	Switching position	General movement	Rated current	Packing/Box (pcs)	Catalogue number
TZ - 6102	oil-resistant cylinder with metal roll	500g	100g	1mm	3.5mm	15A-active 5A-inductive	1 / 50	466102

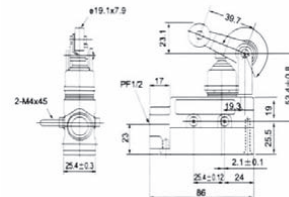

Type	Type of the head	Power of starting	Power of release	Switching position	General movement	Rated current	Packing/Box (pcs)	Catalogue number
TZ - 6104	oil-resistant horizontal lever with metal roll	640g	230g	5mm	6mm	15A-active 5A-inductive	1 / 50	466104

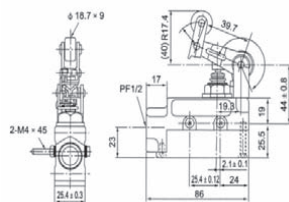

Type	Type of the head	Power of starting	Power of release	Switching position	General movement	Rated current	Packing/Box (pcs)	Catalogue number
TZ - 6143	oil-resistant vertical lever with metal roll	640g	230g	5mm	6mm	15A-active 5A-inductive	1 / 50	466143

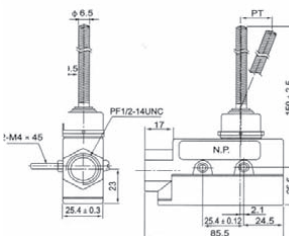

Type	Type of the head	Power of starting	Power of release	Switching position	General movement	Rated current	Packing/Box (pcs)	Catalogue number
TZ - 6106	spring lever	150g	-	20°	-	-	1 / 50	466106

Limit switches of the CM series are used mainly as replacement of the limit switches of the TZ series or for setting the movement limits of some types of equipment. The switches are supplied with screw cable terminals. They can work at resistance loads as high as 15A, and are of single circuit type. Limit switches have high accuracy and can operate at wide variety of speeds.

Items are compliant with the following standards:

EN 60947-1; EN 60947-5-1

Universal Limit Switch – Series CM-1xxx

- * Dielectric Strength: 1000V AC
- * Insulation Resistance: 100mΩ min. (at 500VDC)
- * Contact Resistance: 5mΩ
- * Electrical Life (No. of cycles): 500 000 with non-inductive load
- * Mechanical Life (No. of cycles): 5 000 000
- * Operating frequency: 20 electrical operations/minute
- * Operating speed: 0.1mm/s to 1.0m/s
- * Rated voltage: 230V
- * Degree of protection: IP65
- * Fastening strength of terminals: 6-8kgf/cm

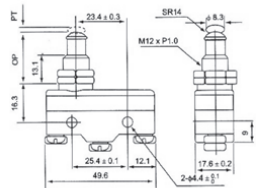
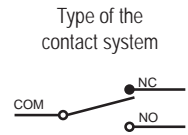

Type	Type of the head	Power of starting	Power of release	Switching position	General movement	Rated current	Packing/Box (pcs)	Catalogue number
CM - 1307	Metal cylinder	350g	114g	0.4mm	5.5mm	15A-active 5A-inductive	1 / 480	468105

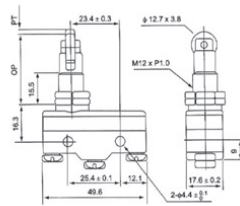

Type	Type of the head	Power of starting	Power of release	Switching position	General movement	Rated current	Packing/Box (pcs)	Catalogue number
CM - 1309	Cylinder and transverse metal roll	350g	114g	0.4mm	5.5mm	15A-active 5A-inductive	1 / 480	468106

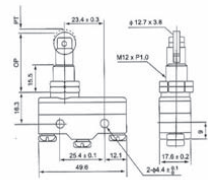

Type	Type of the head	Power of starting	Power of release	Switching position	General movement	Rated current	Packing/Box (pcs)	Catalogue number
CM - 1308	Cylinder longitudinal metal roll	350g	114g	0.4mm	5.5mm	15A-active 5A-inductive	1 / 480	468109

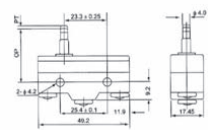

Type	Type of the head	Power of starting	Power of release	Switching position	General movement	Rated current	Packing/Box (pcs)	Catalogue number
CM - 1305	Metal cylinder	350g	114g	0.4mm	1.6mm	15A-active 5A-inductive	1 / 480	468110

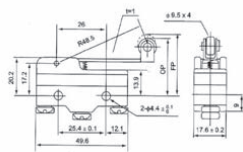

Type	Type of the head	Power of starting	Power of release	Switching position	General movement	Rated current	Packing/Box (pcs)	Catalogue number
CM - 1703	Extended metal roll	160g	22g	7.1mm	1.02mm	15A-active 5A-inductive	1 / 480	468113

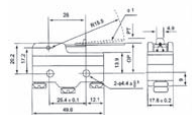

Type	Type of the head	Power of starting	Power of release	Switching position	General movement	Rated current	Packing/Box (pcs)	Catalogue number
CM - 1705	Spring lever	10g	3g	20mm	5.6mm	15A-active 5A-inductive	1 / 480	468117

Limit switches

The all-purpose limit switches are devices used for setting gearing limits. They are mounted on transport lines, conveyors and other linear progressive motion machines. They have small dimensions and a vibration-resistant metal shell with plastic lid, resistant to oil and water.

Product conformity documentation:

Standard: EN 60947-1; EN 60947-5-1

All-purpose limit switch – series TZ-8xxx

- * Dielectric strength: 1000V AC
- * Insulating resistance: 100MΩ
- * Contact Resistance: 25mΩ
- * Electrical endurance (number of cycles): 500 000 with active load
- * Mechanical endurance (number of cycles): 5 000 000
- * Gearing speed: 5mm/s to 0.5 m/s
- * Rated voltage: 230V
- * Protection degree: IP40
- * Cable input: cable gland PG11
- * Section of power supply conductor: up to 2mm
- * Fastening strength of terminals: 6-8kgf/cm

Type of the contact system

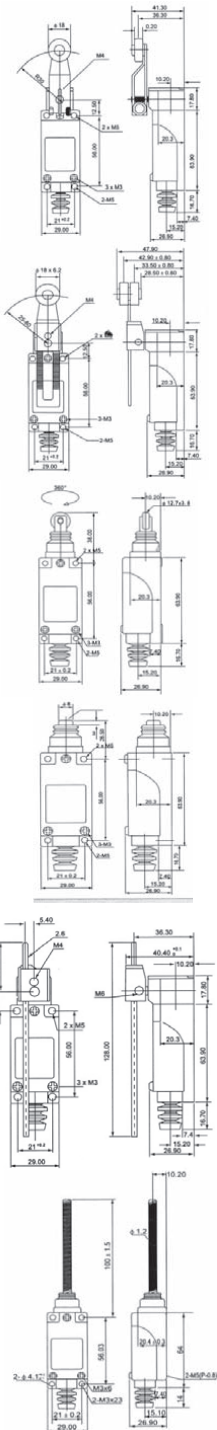
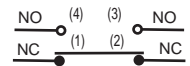

Type	Type of the head	Power of starting	Power of release	Switching position	General movement	Rated current	Packing/Box (pcs)	Catalogue number
TZ - 8104	lever with plastic roll	750g	100g	20°	50°	5A-active 3A-inductive	10 / 100	468104

Type	Type of the head	Power of starting	Power of release	Switching position	General movement	Rated current	Packing/Box (pcs)	Catalogue number
TZ - 8108	adjustable lever with plastic roll	750g	100g	20°	50°	5A-active 3A-inductive	10 / 100	468108

Type	Type of the head	Power of starting	Power of release	Switching position	General movement	Rated current	Packing/Box (pcs)	Catalogue number
TZ - 8112	cylinder with metal roll	900g	150g	1.5mm	4.0mm	5A-active 3A-inductive	10 / 100	468112

Type	Type of the head	Power of starting	Power of release	Switching position	General movement	Rated current	Packing/Box (pcs)	Catalogue number
TZ - 8111	metal cylinder	900g	150g	1.5mm	4.0mm	5A-active 3A-inductive	10 / 100	468111

Type	Type of the head	Power of starting	Power of release	Switching position	General movement	Rated current	Packing/Box (pcs)	Catalogue number
TZ - 8107	metal rod	750g	100g	20°	50°	5A-active 3A-inductive	10 / 100	468107

Type	Type of the head	Power of starting	Power of release	Switching position	General movement	Rated current	Packing/Box (pcs)	Catalogue number
TZ - 8167	spring lever	150g	-	30mm	-	5A-active 3A-inductive	10 / 100	468167

The all-purpose limit switches are devices used for setting gearing limits. They are mounted on transport lines, conveyors and other linear progressive motion machines. They have aluminium shell of high mechanic strength and resistance to oil, water and pressure.

Product conformity documentation:
Standard: EN 60947-1; EN 60947-5-1

All-purpose limit switch – series CWL-xxx

- * Dielectric strength: 1000V AC
- * Insulating resistance: 100mΩ
- * Contact resistance: 15mΩ
- * Electrical endurance (number of cycles): 500 000 with active load
- * Mechanical endurance (number of cycles): 10 000 000
- * Gearing speed: 1mm/s to 2 m/s
- * Rated voltage: 230V
- * Protection degree: IP66
- * Cable input: cable gland
- * Metal shell
- * Vibration-resistant

Type of the contact system

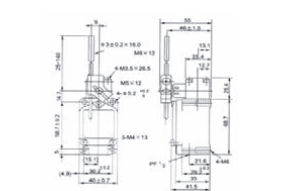
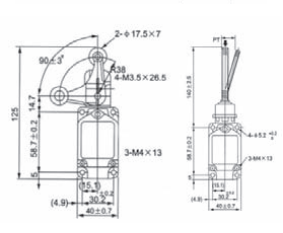
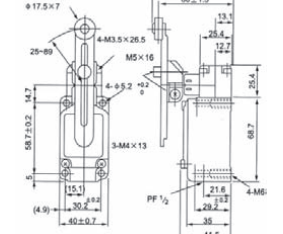
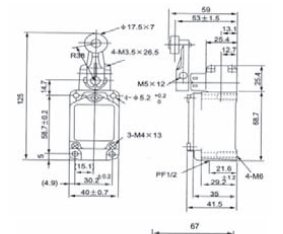
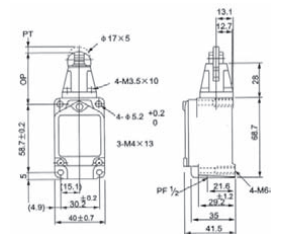
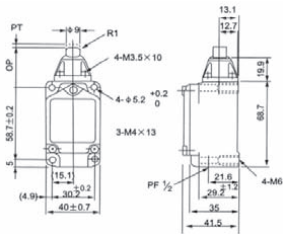
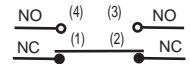

Type	Type of the head	Power of start-ing	Power of release	Switch-ing position	General move-ment	Rated current	Packing/Box (pcs)	Catalogue number
CWLD	metal cylinder	2720g	910g	2.0mm	6.4mm	10A-active 3A-inductive	1 / 50	46LD

Type	Type of the head	Power of start-ing	Power of release	Switch-ing position	General move-ment	Rated current	Packing/Box (pcs)	Catalogue number
CWLD2	cylinder with metal roll	2720g	910g	2.0mm	5.6mm	10A-active 3A-inductive	1 / 50	46LD2

Type	Type of the head	Power of start-ing	Power of release	Switch-ing position	General move-ment	Rated current	Packing/Box (pcs)	Catalogue number
CWLCA2-2	lever with metal roll	1360g	227g	20°	50°	10A-active 3A-inductive	1 / 50	46LCA2-2

Type	Type of the head	Power of start-ing	Power of release	Switch-ing position	General move-ment	Rated current	Packing/Box (pcs)	Catalogue number
CWLCA12-2-Q	adjustable lever with metal roll	2720g	910g	20°	50°	10A-active 3A-inductive	1 / 50	46LCA12-2-Q

Type	Type of the head	Power of start-ing	Power of release	Switch-ing position	General move-ment	Rated current	Packing/Box (pcs)	Catalogue number
CWLCA32-41	fork	1200g	-	55°	90±10°	10A-active 3A-inductive	1 / 50	46LCA32-41

Type	Type of the head	Power of start-ing	Power of release	Switch-ing position	General move-ment	Rated current	Packing/Box (pcs)	Catalogue number
CWLNJ	oil-resistant spring lever	150g	-	28mm		10A-active 3A-inductive	1 / 50	46LNJ

Type	Type of the head	Power of start-ing	Power of release	Switch-ing position	General move-ment	Rated current	Packing/Box (pcs)	Catalogue number
CWLCL	metal rod	142g	28g	20°	50°	10A-active 3A-inductive	1 / 50	46LCL

Limit switches



Limit switches of the CZ 93 series are Safety Key Interlock Switches. They are used in object control systems with high safety requirements. The limit switch body is mounted to the fixed system component, while the safety key is mounted to the movable system component. System operation cannot start, unless a full interlocking is achieved. Safety key interlock switches can operate at up to 10A non-inductive resistance load, 3A lamp load and 5A inductive load. They have high operating accuracy at wide variety of speeds. These limit switches are available in two versions depending on the operating contacts number: 2NC and NO+NC

Items are compliant with the following standards:

EN 60947-1; EN 60947-5-1

Universal Limit Switch – Series CZ93-xx

Dielectric Strength: 2500V AC

Insulation Resistance: 100mΩ min. (at 500VDC)

Contact Resistance: 25mΩ

Electrical Life (No. of cycles): 50 000 with non-inductive load

Mechanical Life (No. of cycles): 2 000 000

Operating frequency: 30 electrical operations/minute

Operating speed: 0.1mm/s to 0.5m/s

Rated voltage: 230V

Degree of protection: IP65

Type of the contact system

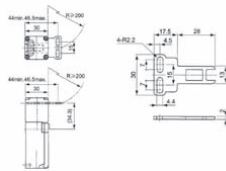
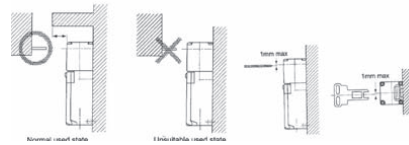
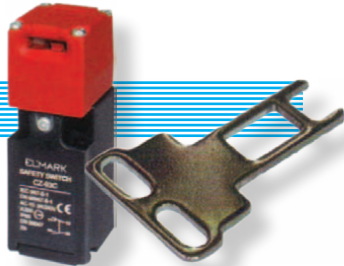
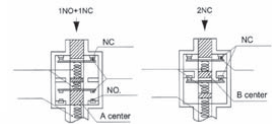

Type	Key type	Power of starting	Power of release	Switching position	General movement	Rated current	Packing/Box (pcs)	Catalogue number
CZ-93BPG01	CZ93-K1	147N	29.4N	6 mm	28mm	10A-active 3A-inductive	10 / 100	46CZ08
CZ-93CPG01	CZ93-K1	147N	29.4N	6 mm	28mm	10A-active 3A-inductive	10 / 100	46CZ09

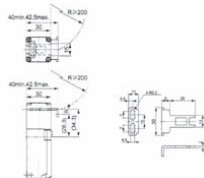
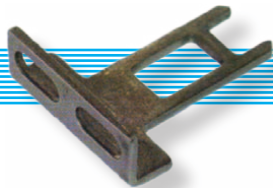

Type	Key type	Power of starting	Power of release	Switching position	General movement	Rated current	Packing/Box (pcs)	Catalogue number
CZ-93BPG02	CZ93-K2	147N	29.4N	6 mm	28mm	10A-active 3A-inductive	10 / 100	46CZ10
CZ-93CPG02	CZ93-K2	147N	29.4N	6 mm	28mm	10A-active 3A-inductive	10 / 100	46CZ11

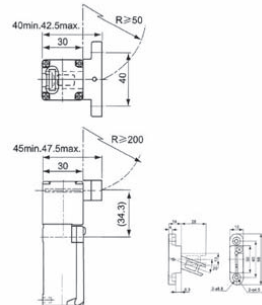

Type	Key type	Power of starting	Power of release	Switching position	General movement	Rated current	Packing/Box (pcs)	Catalogue number
CZ-93BPG03	CZ93-K3	147N	29.4N	6 mm	28mm	10A-active 3A-inductive	10 / 100	46CZ12
CZ-93CPG03	CZ93-K3	147N	29.4N	6 mm	28mm	10A-active 3A-inductive	10 / 100	46CZ13

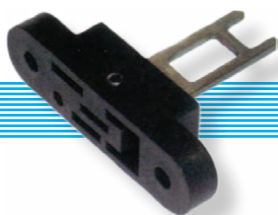

Type	Key Actuating	Packing / Box (pcs)	Catalogue number
CZ 93 - K 1	Horizontal	1 / 100	46CZ931
CZ 93 - K 2	Vertical	1 / 100	46CZ932
CZ 93 - K 3	Adjustable	1 / 100	46CZ933

Proximity induction sensors are all-purpose switches used in machine systems and equipment for no contact surveillance of metal elements motion. They can also be used in other machine systems applications as no contact control sensors for level of liquids, control sensors for the speed and position of rotating chains, etc. They are developed on the base of PNP and NPN transition. They have small dimensions and feature a metal cylindrical shell resistant to vibrations and a plastic lid which is oil and water resistant.

All-purpose proximity switch – series LM xx

- * Insulating resistance: $\geq 50\text{ M}\Omega$
- * Gearing distance: from 2 mm to 7 mm
- * Precision of repetition: 0.01
- * Ambient temperature: -25°C to $+70^\circ\text{C}$
- * Gearing speed: 5mm/s
- * Rated voltage: 6-36VDC; 90-230VAC
- * Protection degree: IP 67

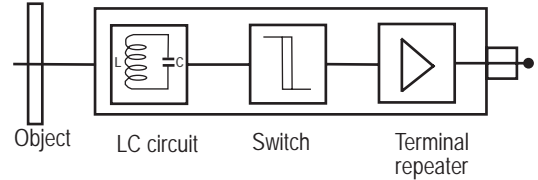

EL-LM8

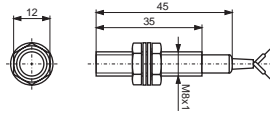

EL-LM12

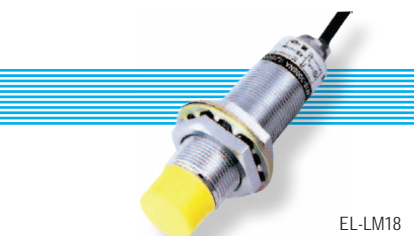
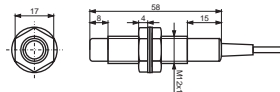
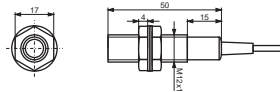

EL-LM18

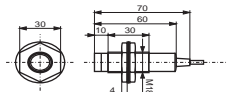
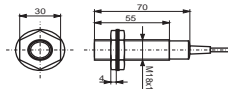

EL-LM22

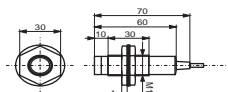
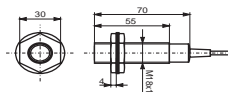
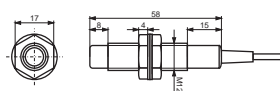
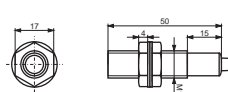
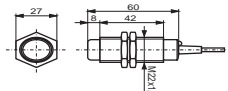

Type	Start distance	Min. size of object	Power supply voltage	Type of transition contact	Type of load	Output	Packing / Box (pcs)	Catalogue number
EL-LM8-3002NA	2 mm	8 x 8 x 1	24 VDC	NPN	NO	130 mA	2 / 200	46LM 8-32NA
EL-LM8-3002NB	2 mm	8 x 8 x 1	24 VDC	NPN	NC	130 mA	2 / 200	46LM 8-32NB
EL-LM8-3002PA	2 mm	8 x 8 x 1	24 VDC	PNP	NO	130 mA	2 / 200	46LM 8-32PA
EL-LM8-3002PB	2 mm	8 x 8 x 1	24 VDC	PNP	NC	130 mA	2 / 200	46LM 8-32PB
EL-LM8-2002A	2 mm	8 x 8 x 1	230 VAC	SCR	NO	150 mA	2 / 200	46LM 8-22A

Type	Start distance	Min. size of object	Power supply voltage	Type of transition contact	Type of load	Output	Packing / Box (pcs)	Catalogue number
EL-LM12-3004NA	4 mm	15 x 15 x 1	24 VDC	NPN	NO	200 mA	2 / 200	46LM 12-34NA
EL-LM12-3004NB	4 mm	15 x 15 x 1	24 VDC	NPN	NC	200 mA	2 / 200	46LM 12-34NB
EL-LM12-3004PA	4 mm	15 x 15 x 1	24 VDC	PNP	NO	200 mA	2 / 200	46LM 12-34PA
EL-LM12-3004PB	4 mm	15 x 15 x 1	24 VDC	PNP	NC	200 mA	2 / 200	46LM 12-34PB
EL-LM12-2004A	4 mm	15 x 15 x 1	230 VAC	SCR	NO	300 mA	2 / 200	46LM 12-24A

Type	Start distance	Min. size of object	Power supply voltage	Type of transition contact	Type of load	Output	Packing / Box (pcs)	Catalogue number
EL-LM18-3008NA	8 mm	18 x 18 x 1	24 VDC	NPN	NO	200 mA	1 / 100	46LM 18-38NA
EL-LM18-3008NB	8 mm	18 x 18 x 1	24 VDC	NPN	NC	200 mA	1 / 100	46LM 18-38NB
EL-LM18-3008PA	8 mm	18 x 18 x 1	24 VDC	PNP	NO	200 mA	1 / 100	46LM 18-38PA
EL-LM18-3008PB	8 mm	18 x 18 x 1	24 VDC	PNP	NC	200 mA	1 / 100	46LM 18-38PB
EL-LM18-2008A	8 mm	18 x 18 x 1	230 VAC	SCR	NO	300 mA	1 / 100	46LM 18-28A

Type	Start distance	Min. size of object	Power supply voltage	Type of transition contact	Type of load	Output	Packing / Box (pcs)	Catalogue number
EL-LM22-3010NA	10 mm	22x 22 x 1	24 VDC	NPN	NO	200 mA	1 / 100	46LM 22-30NA
EL-LM22-3010NB	10 mm	22x 22 x 1	24 VDC	NPN	NC	200 mA	1 / 100	46LM 22-30NB
EL-LM22-3010PA	10 mm	22x 22 x 1	24 VDC	PNP	NO	200 mA	1 / 100	46LM 22-30PA
EL-LM22-3010PB	10 mm	22x 22 x 1	24 VDC	PNP	NC	200 mA	1 / 100	46LM 22-30PB
EL-LM22-2010A	10 mm	22x 22 x 1	230 VAC	SCR	NO	300 mA	1 / 100	46LM 22-20A

Type	Start distance	Min. size of object	Power supply voltage	Type of transition contact	Type of load	Output	Packing / Box (pcs)	Catalogue number
EL-LM12-4002A	2 mm	15 x 15 x 1	230 V	inductive	NO	100 mA	2 / 200	46LM 12-44A
EL-LM12-4004A	4 mm	15 x 15 x 1	230 V	inductive	NO	300 mA	2 / 200	46LM 12-46A

Type	Start distance	Min. size of object	Power supply voltage	Type of transition contact	Type of load	Output	Packing / Box (pcs)	Catalogue number
EL-LM18-4006A	5 mm	18 x 18 x 1	230 V	inductive	NO	100 mA	1 / 100	46LM 18-44A
EL-LM18-4008A	8 mm	18 x 18 x 1	230 V	inductive	NO	300 mA	1 / 100	46LM 18-48A

Capacitive sensors

Capacitive sensors are used in machine systems and equipment for no-contact motion surveillance. They consist of two coaxial electrodes, a condenser and RC generator. This type of sensors reacts to both metal and non-metal objects, as the gearing distance for non-metal objects depends on their dielectric constants. They allow gearing distance adjustment for non-magnetic conductive materials. They are developed on the base of PNP and NPN transition. They have small dimensions and feature a metal cylindrical shell resistant to vibrations and a plastic lid which is oil and water resistant.

Capacitive sensors – series CM xx

- * Insulating resistance: $\geq 50 \text{ M } \Omega$
- * Gearing distance: from 2 mm to 15 mm
- * Precision of repetition: 0.01
- * Ambient temperature: -25°C to $+70^{\circ}\text{C}$
- * Gearing speed: 5mm/s
- * Rated voltage: 6~36VDC; 90~230VAC
- * Protection degree: IP 54

General scheme of a capacitive transducer

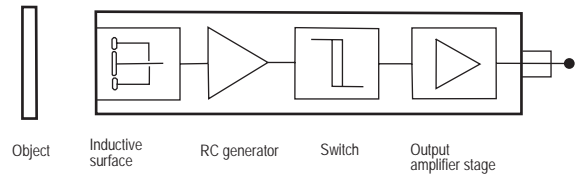

EL-CM12



EL-CM18



EL-CM24



EL-SM12



EL-XM18

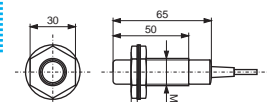
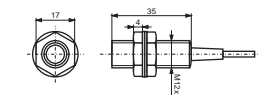
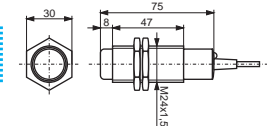
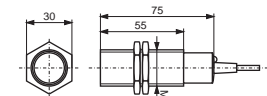
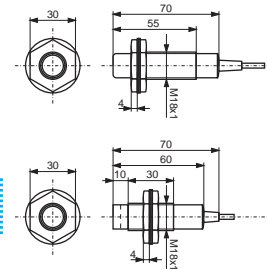
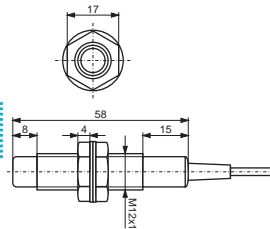

Type	Start distance	Power supply voltage	Type of transition	Type of contact	Output load	Packing / Box (pcs)	Catalogue number
EL-CM12-3004NA	0-4 mm	24 VDC	NPN	NO	200 mA	1 / 100	46CM 12-32NA
EL-CM12-3004NB	0-4 mm	24 VDC	NPN	NC	200 mA	1 / 100	46CM 12-32NB
EL-CM12-3004PA	0-4 mm	24 VDC	PNP	NO	200 mA	1 / 100	46CM 12-32PA
EL-CM12-3004PB	0-4 mm	24 VDC	PNP	NC	200 mA	1 / 100	46CM 12-32PB

Type	Start distance	Power supply voltage	Type of transition	Type of contact	Output load	Packing / Box (pcs)	Catalogue number
EL-CM18-3008NA	0-8 mm	24 VDC	NPN	NO	200 mA	1 / 100	46CM 18-38NA
EL-CM18-3008NB	0-8 mm	24 VDC	NPN	NC	200 mA	1 / 100	46CM 18-38NB
EL-CM18-3008PA	0-8 mm	24 VDC	PNP	NO	200 mA	1 / 100	46CM 18-38PA
EL-CM18-3008PB	0-8 mm	24 VDC	PNP	NC	200 mA	1 / 100	46CM 18-38PB
EL-CM18-2008A	0-8 mm	230 VAC	SCR	NO	300 mA	1 / 100	46CM 18-28A

Type	Start distance	Power supply voltage	Type of transition	Type of contact	Output load	Packing / Box (pcs)	Catalogue number
EL-CM24-3012NA	8 mm	24 VDC	NPN	NO	200 mA	1 / 100	46CM 24-12NA
EL-CM24-3012NB	8 mm	24 VDC	NPN	NC	200 mA	1 / 100	46CM 24-12NB
EL-CM24-3012PA	8 mm	24 VDC	PNP	NO	200 mA	1 / 100	46CM 24-12PA
EL-CM24-3012PB	8 mm	24 VDC	PNP	NC	200 mA	1 / 100	46CM 24-12PB
EL-CM24-2012A	8 mm	230 VAC	SCR	NO	300 mA	1 / 100	46CM 24-12A

Type	Start distance	Power supply voltage	Type of transition	Type of contact	Output load	Packing / Box (pcs)	Catalogue number
EL-SM12-3110NA	10 mm	24 VDC	NPN	NO	200 mA	2 / 200	46SM 12-31NA
EL-SM12-3110NB	10 mm	24 VDC	NPN	NC	200 mA	2 / 200	46SM 12-31NB
EL-SM18-3110PA	10 mm	24 VDC	PNP	NO	200 mA	1 / 100	46SM 18-31PA
EL-SM18-3110PB	10 mm	24 VDC	PNP	NC	200 mA	1 / 100	46SM 18-31PB

Type	Start distance	Power supply voltage	Type of transition	Type of contact	Output load	Packing / Box (pcs)	Catalogue number
EL-XM18-305PMI	5 mm	24 VDC	inductive	NO	100 mA	1 / 100	46XM 18-35A
EL-XM18-305PMU	5 mm	24 VDC	inductive	NC	100 mA	1 / 100	46XM 18-35B

Note: Sensor of Hal

Type	Start distance	Power supply voltage	Type of transition	Type of contact	Output load	Packing / Box (pcs)	Catalogue number
EL-XM24-308PMI	8 mm	24 VDC	inductive	NO	300 mA	1 / 100	46XM 24-38A
EL-XM24-308PMU	8 mm	24 VDC	inductive	NC	300 mA	1 / 100	46XM 24-38B

Note: MI - current type
MU - voltage type

Photoelectrical sensors of the Gxx series are all-purpose switches used in machine systems and equipment for no contact surveillance of motion of elements. They are based on the photoelectric principle of operation – inside the sensor there is a photo signal emitter and receiver of the returned signal. There are three types of sensors: diffuse sensors, reflector sensors and emitter-receiver sensors. These types of sensors differ in the way of returning the signal. They allow for gearing distance adjustment. They are developed on the base of PNP and NPN transition. They have small dimensions and feature a metal cylindrical shell resistant to vibrations and a plastic lid which is oil and water resistant.

Technical features:

- * Insulating resistance: $\geq 50 \text{ M } \Omega$
- * Gearing distance: from 2 mm to 7 mm
- * Precision of repetition: 0.01
- * Ambient temperature: -25°C to $+70^{\circ}\text{C}$
- * Gearing speed: 5mm/s
- * Rated voltage: 6–36VDC; 90–230VAC
- * Protection degree: IP 67

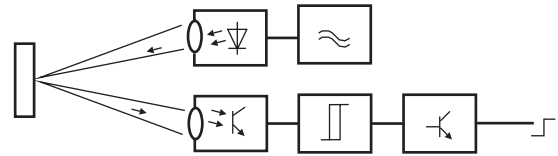

EL-G12



EL-G18

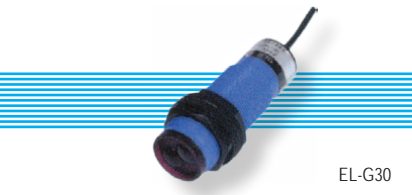
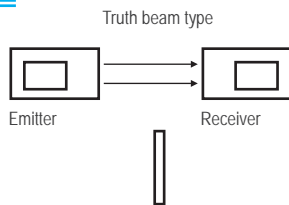

EL-G30

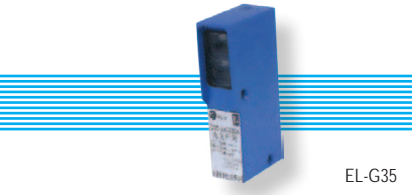
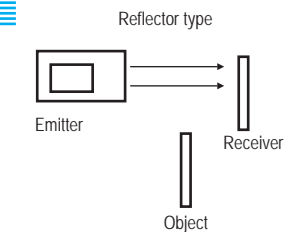

EL-G35

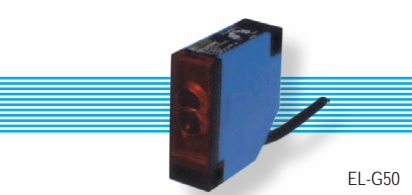
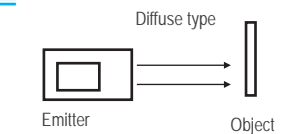

EL-G50

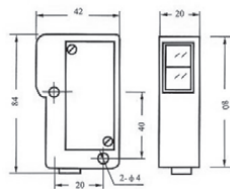

EL-BZJ

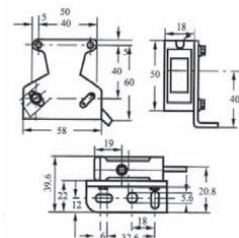

Type	Start distance	Power supply voltage	Type of transition	Type of contact	Type of sensor	Packing / Box (pcs)	Catalogue number
EL-G12-3A07NA	70 mm	24 VDC	NPN	Ø12; l=50	Diffuse	1 / 100	46G12A071
EL-G12-3A07PA	70 mm	24 VDC	PNP	Ø12; l=50	Diffuse	1 / 100	46G12A072
EL-G12-3B1NA	1 m	24 VDC	NPN	Ø12; l=50	Reflector	1 / 100	46G123B11
EL-G12-3B1PA	1 m	24 VDC	PNP	Ø12; l=50	Reflector	1 / 100	46G123B12
EL-G12-3C3NA	3 m	24 VDC	NPN	Ø12; l=50	Truth beam	1 / 100	46G123C11
EL-G12-3C3PA	3 m	24 VDC	PNP	Ø12; l=50	Truth beam	1 / 100	46G123C12

Type	Start distance	Power supply voltage	Type of transition	Type of contact	Type of sensor	Packing / Box (pcs)	Catalogue number
EL-G18-3A10NA	100 mm	24 VDC	NPN	Ø18; l=70	Diffuse	1 / 100	46G18A101
EL-G18-3A10PA	100 mm	24 VDC	PNP	Ø18; l=70	Diffuse	1 / 100	46G18A102
EL-G18-3B2NA	2 m	24 VDC	NPN	Ø18; l=70	Reflector	1 / 100	46G183B11
EL-G18-3B2PA	2 m	24 VDC	PNP	Ø18; l=70	Reflector	1 / 100	46G183B12
EL-G18-3C5NA	5 m	24 VDC	NPN	Ø18; l=70	Truth beam	1 / 100	46G185C11
EL-G18-3C5PA	5 m	24 VDC	PNP	Ø18; l=70	Truth beam	1 / 100	46G185C12

Type	Start distance	Power supply voltage	Type of transition	Type of contact	Type of sensor	Packing / Box (pcs)	Catalogue number
EL-G30-3A70NA	500 mm	24 VDC	NPN	Ø22; l=70	Diffuse	1 / 100	46G30A101
EL-G30-3A70PA	500 mm	24 VDC	PNP	Ø22; l=70	Diffuse	1 / 100	46G30A102
EL-G30-3B3NA	3 m	24 VDC	NPN	Ø22; l=70	Reflector	1 / 100	46G303B11
EL-G30-3B3PA	3 m	24 VDC	PNP	Ø22; l=70	Reflector	1 / 100	46G303B12
EL-G30-3C101NA	10 m	24 VDC	NPN	Ø22; l=70	Truth beam	1 / 52	46G305C11
EL-G30-3C101PA	10 m	24 VDC	PNP	Ø22; l=70	Truth beam	1 / 52	46G305C12

Type	Start distance	Power supply voltage	Type of transition	Type of contact	Type of sensor	Packing / Box (pcs)	Catalogue number
EL-G35-3A50NA	500 mm	24 VDC	NPN	NO	Diffuse	1 / 100	46G35A101
EL-G35-3A50PA	500 mm	24 VDC	PNP	NO	Diffuse	1 / 100	46G35A102
EL-G35-3B3NA	3 m	24 VDC	NPN	NO	Reflector	1 / 100	46G353B11
EL-G35-3B3PA	3 m	24 VDC	PNP	NO	Reflector	1 / 100	46G353B12
EL-G35-3C5NA	5 m	24 VDC	NPN	NO	Truth beam	1 / 50	46G355C11
EL-G35-3C5PA	5 m	24 VDC	PNP	NO	Truth beam	1 / 50	46G355C12

Type	Start distance	Power supply voltage	Type of transition	Type of contact	Type of sensor	Packing / Box (pcs)	Catalogue number
EL-G50-3A30NA	500 mm	24 VDC	NPN	NO	Diffuse	1 / 100	46G50A101
EL-G50-3A30PA	500 mm	24 VDC	PNP	NO	Diffuse	1 / 100	46G50A102
EL-G50-3B4NA	4 m	24 VDC	NPN	NO	Reflector	1 / 100	46G503B11
EL-G50-3B4PA	4 m	24 VDC	PNP	NO	Reflector	1 / 100	46G503B12
EL-G50-3C5NA	5 m	24 VDC	NPN	NO	Truth beam	1 / 50	46G505C11
EL-G50-3C5PA	5 m	24 VDC	PNP	NO	Truth beam	1 / 50	46G505C12

Type	Start distance	Power supply voltage	Type of transition	Type of contact	Type of sensor	Packing / Box (pcs)	Catalogue number
EL-BZJ-211	10 mm	24 VDC	Reflector	NO	Colour detector	1 / 50	46BZJ211
EL-BZJ-311	9mm	24 VDC	Reflector	NO	Colour detector	1 / 50	46BZJ311
EL-BZJ-411	9mm	24 VDC	Reflector	NO	Colour detector	1 / 50	46BZJ411

Float switches

Float switches of the type QW-xx-xx are sealed units for direct pump control. They are intended for continuous liquid level maintenance in pools, tanks or ponds exercised through direct control of the pumping in or out process in the respective reservoir. They are pre-wired and depending on the chosen configuration can control either the pumping in, or pumping out of the reservoir. They allow direct control of single phase pumps with mounted power of 1 kW. Float switches are waterproof.

The automatic level control units of the DHC1Y-xx series are intended for mounting on pumping control panels. They do not use any additional sensors, but conductive probes to contact the liquid. The unit sends low (harmless) voltage signals to the probes and once a contact between a probe and liquid is established, the unit changes its contactors' state. Units are available in three variants with different number of control contacts suitable for different applications. Each contact can transfer current of up to 5A, which is enough to ensure control over the powerful pumps' contactors or to directly control pumps with mounted power of 1 kW. The automatic level control units can be installed on a DIN rail.

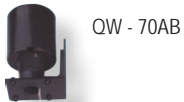

QW - 70AB



QW - M 15 - 3

Type	Number of probes (No. of levels)	Output Load (A)	Accuracy	Operating Voltage (V)	Note	Packing / Box (pcs)	Catalogue number
DHC1Y - S	1	5	±1%	230	-	100	46DW001
DHC1Y - SD	3	5	±1%	230	-	100	46DW002
DHC1Y - T	1	5	±1%	230	2 pumps control	100	46DW003

Type	Number of probes (No. of levels)	Output Load (A)	Accuracy	Operating Voltage (V)	Note	Packing / Box (pcs)	Catalogue number
QW - M 15 - 3	2	6	±1%	230	-	1 / 30	46DW004
QW - 70AB	2	4	±1%	230	-	1 / 20	46DW005

Power supplies

The DRP-xx-xx series of power supplies are voltage reduction and rectification units ideally suited to provide stable power supply of systems and equipment for contact-free movement monitoring elements (such as inductive, capacity and photo sensors, logic elements and systems, etc.). They have small overall dimensions and can be installed on a DIN rail. The power units have metal or plastic cases resistant to vibrations and plastic oil- and waterproof covers. They are able to provide stable output voltage at comparatively fluctuating input voltage. Devices have built-in overload and short circuit protection, allowing short time overload of up to 130%. Power supplies are available with various output voltages (5, 12, 15 and 24 V DC) and different output power rates.

Technical Specifications:

- * Input voltage: 80 ~ 230V AC
- * Over-voltage: 115 ~ 135% of the rated output voltage
- * Overload: 120 ~ 120% of the rated output power
- * Terminals: Input – 2 screw terminals; Output: 4 screw terminals;
- * Protection level: IP44
- * Power indicator
- * Installation: DIN rail
- * Cooling: Free air cooling convection



Type	Output Voltage (V)	Output Load (A)	Tolerance	Power (W)	Dimensions WH/L (mm)	Packing / Box (pcs)	Catalogue number
DR - 45 - 5	5	5	±2%	25	78 / 93 / 56	1 / 50	46DR455
DR - 45 - 12	12	3.5	±1%	42	78 / 93 / 56	1 / 50	46DR4512
DR - 45 - 15	15	2.8	±1%	42	78 / 93 / 56	1 / 45	46DR4515
DR - 45 - 24	24	2	±1%	48	78 / 93 / 56	1 / 16	46DR4524

Type	Output Voltage (V)	Output Load (A)	Tolerance	Power (W)	Dimensions WH/L (mm)	Packing / Box (pcs)	Catalogue number
DR - 75 - 12	12	6.3	±2%	75	55.5 / 125.3 / 100	1 / 18	46DR7512
DR - 75 - 24	24	3.2	±1%	75	55.5 / 125.3 / 100	1 / 18	46DR7524
DRP - 240 - 24	24	10	±1%	240	125.5 / 125.3 / 100	1 / 12	46DR2424

Rotary switches LW26 series

The rotary switches LW26 series are produced for switching on/off electrical circuits with commutated current from 20 to 160A. They are designed on the bases of the rotor-eccentric switching on which is realized through turning of the handle to 60 or 90 degrees. The normal operation is used for commutation of two, three or four conductor systems. There are special rotary switches that switch on under given connection schemes and are used to control motors, electric welding machines and other consumers.

Documentation corresponding to the product:

Standard: EN 60947-1; EN 60947-3-1

Technical data:

- * Power supply voltage: 230/400V; 50Hz
- * Insulation voltage: 690V
- * Impulse voltage wear resistance: 6000V
- * Mechanical wear resistance: 3x10⁵ commutation cycles
- * Operating temperature: -10 - +50°C
- * Humidity: 35 – 85% RH
- * Commuting capacity: up to 160A according to the tables
- * Plastic: UV rays wear resistance
- * IP code:
 - IP42 for the ordinary breakers mounted in a panel
 - IP65 for the breakers offered in a box
- * Cable connection: screw joining
- * Tightening moment of the bolt: 1.33N
- * Maximum section of the power supply conductors: according to the dimensions table
- * Weight: according to the number of the contacts

Mounting:

- * directly to the control panel
- * thickness of the surface to which it is mounted: max 5mm

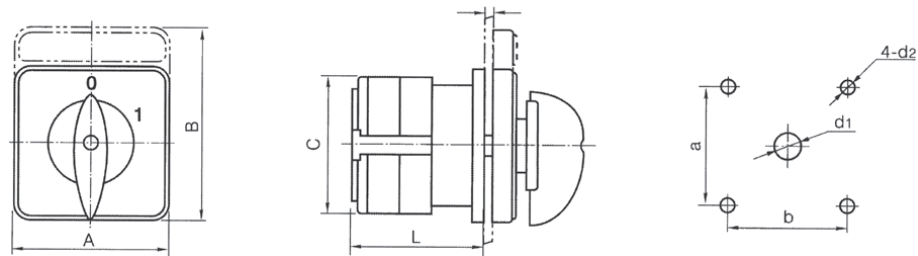

Dimensions

Dimensions	Front panel	Joining conductor (mm ²)	Overall dimensions (mm)				Mounting dimensions (mm)			
			A	B	C	L	a	b	d1	d2
LW26-20	M1 panel	1x2.5	48	48	43	22 + 9.6n	36	36	Ø8.5	Ø4.5
	M1 panel with inscription field		48	60	43	22 + 9.6n	36	36	Ø8.5	Ø4.5
LW26-25	M1 panel	1x4.0	48	48	45.2	23+12.8n	36	36	Ø8.5	Ø4.5
LW26-32	M2 panel	1x6.0	64	64	58	29.2 + 12.8n	48	48	Ø10	Ø4.5
LW26-63	M2 panel	1x16	64	64	66	29.2 + 21.5n	48	48	Ø10	Ø4.5
LW26-125	M3 panel	1x35	88	88	84	35 + 26.5n	68	68	Ø13	Ø6
LW26-160	M3 panel	1x50	88	88	88	35 + 32.5n	68	68	Ø13	Ø6

* n - number of modules

Rotary switches



Type	Scheme	In (A)	Levels	Packing / Box (pcs)	Catalogue number
LW26 - 10Q	Q10 three-poles switching on; motor starting and stopping; voltage turning on/off to the consumers	10	2	1 / 100	492101
LW26 - 16Q		16	2	1 / 100	492161
LW26 - 20Q		20	2	1 / 100	492201
LW26 - 25Q		25	2	1 / 100	492251
LW26 - 32Q		32	2	1 / 72	492321
LW26 - 63Q		63	2	1 / 64	492631
LW26 - 125Q		125	2	1 / 24	492951
LW26 - 160Q		160	2	1 / 27	492961



Type	Scheme	In (A)	Levels	Packing / Box (pcs)	Catalogue number
LW26GS - 20/04	Q11 three-poles switching over; motor starting and stopping; voltage turning on/off to the consumers; possibility for access control	20	2	1 / 100	492207
LW26GS - 25/04		25	2	1 / 100	492257
LW26GS - 32/04		32	2	1 / 72	492327
LW26GS - 63/04		63	2	1 / 64	492637

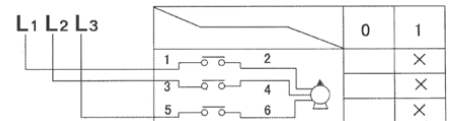
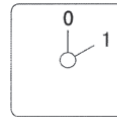

Type	Scheme	In (A)	Levels	Packing / Box (pcs)	Catalogue number
LW26 - 20N	N11 3-position – 2 start positions and 1 stop; for motor reversing	20	3	1 / 100	492202
LW26 - 25N		25	3	1 / 100	492252
LW26 - 32N		32	3	1 / 64	492322
LW26 - 63N		63	3	1 / 48	492632
LW26 - 125N		125	3	1 / 24	492952
LW26 - 160N		160	3	1 / 18	492962

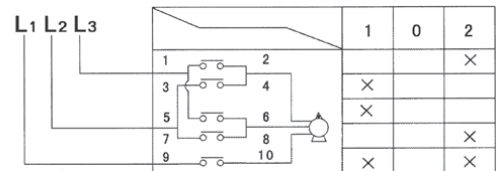
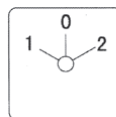

Type	Scheme	In (A)	Levels	Packing / Box (pcs)	Catalogue number
LW26 - 25S	S19 3-position – 2 start positions and 1 stop; for two speed motor control; switching over between charging*	25	4	1 / 100	492253
LW26 - 63S		63	4	1 / 48	492633
LW26 - 125S		125	4	1 / 24	492953
LW26 - 160S		160	4	1 / 18	492963

Note: It is necessary that additional bridges be placed at switching over between charging

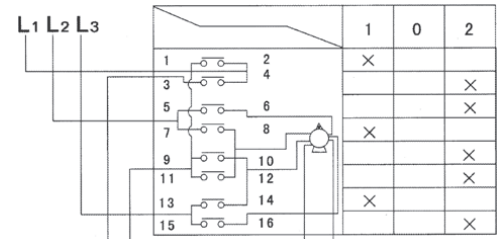
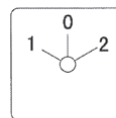



Type	Scheme	In (A)	Levels	Packing / Box (pcs)	Catalogue number
LW26 - 25 SD	S21	25	4	1 / 100	492025
LW26 - 63 SD	3-position switching on star/delta	63	4	1 / 48	492063

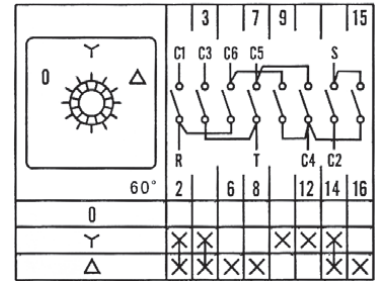

Type	Scheme	In (A)	Levels	Packing / Box (pcs)	Catalogue number
LW26 - 32H 5881/3	H5881/3 - 85 for welding transformer windings switching over	32	3	1 / 64	492324
LW26 - 63H 5881/3		63	3	1 / 48	492634

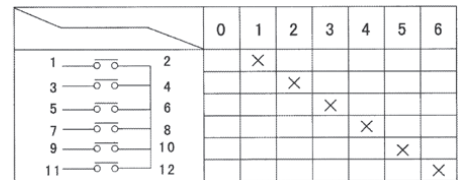
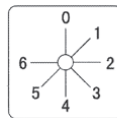

Type	Scheme	In (A)	Levels	Packing / Box (pcs)	Catalogue number
LW26 - 20 YH5/3	YH5/3 - 66 for voltage switching over	20	3	1 / 72	492205

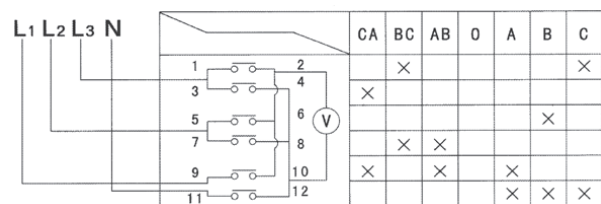
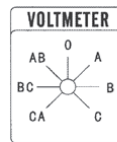

Type	Scheme	In (A)	Levels	Packing / Box (pcs)	Catalogue number
LW26 - 20 LH3/3	LH3/3 - 58 for amperemeter switching on to current transformers	20	3	1 / 100	492206

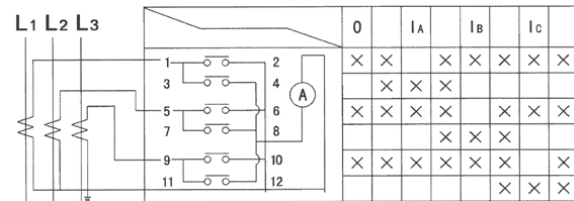
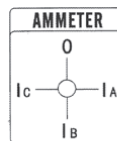

Type	Scheme	Ingress protecting rating	Packing / Box (pcs)	Catalogue number
LW26 - 20-25-Q	Box for LW26-20/25	IP 42	1 / 76	492037
LW26 - 32-Q	Box for LW26-32	IP 42	1 / 30	492038
LW26 - 20-25-DIN	Adaptor for DIN-rail for LW26-20/25		15 / 1500	492039



Type	Scheme	In (A)	Levels	Packing / Box (pcs)	Catalogue number
LW26 4.I7168/7	4.I7168/7	20	7	1 / 100	492028

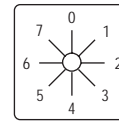

4.I7168/7

	0	1	2	3	4	5	6	7
1								X
3				X				
5				X				
7								X
9		X						
11								X
13					X			
15		X						
17								X
19				X				
21		X						
23					X			
25		X	X	X	X			
27								X



Type	Scheme	In (A)	Levels	Packing / Box (pcs)	Catalogue number
LW26 4.H6518/5	4.H6518/5	25	5	1 / 100	492029

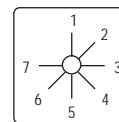

4.H6518/5

	1	2	3	4	5	6	7
1				X	X		
3							
5							
7	X	X					
9							
11							X
13							X
15			X	X			
17							X
19				X	X		

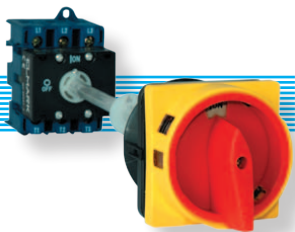

Type	Scheme	In (A)	Levels	Packing / Box (pcs)	Catalogue number
LW30-20	LW30-20	20	3	1 / 32	492030
LW30-32	LW30-32	32	3	1 / 32	492031
LW30-40	LW30-40	40	3	1 / 32	492033
LW30-63	LW30-63	63	3	1 / 32	492034

* Possibility for access control

LW30-20-100A
ON/OFF switch 3 poles

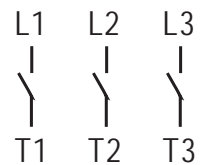

LW30-20-100A
ON/OFF switch 3 poles

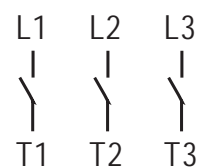

Type	Scheme	Ingress protecting rating	In (A)	Levels	Packing / Box (pcs)	Catalogue number
LW30-32	LW30-32	IP54	32	3	1 / 30	492032

* Possibility for access control

Buttons and LED indicators

These are devices used in control and indication systems, command boards and panels in industrial automation systems. They are manufactured to commute controlling circuits and to control the switching on or off executive mechanisms such as relays, contactors, etc. The signal lamps and indicators find broad application in all industrial fields. The devices endure short time current overload up to 10A, and normally they can commute thermal current up to 6A in their contact system. The connection to the contact terminals is through screw terminals to which operational conductors with section up to 2.5mm² can be joined.

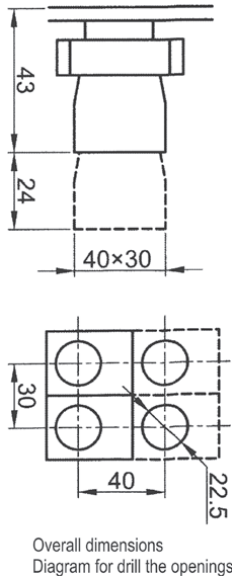

Documentation corresponding to the product:
Standard: EN 60947-1; EN 60947-5-1

Technical data:

- * Insulation voltage: 660V; 50/60Hz
- * Impulse voltage wear resistance: 6000V;
- * Rated current: 6A (230V AC); 0.3A (230V DC)
- * Short circuit protection: safety device 10A gG outside in the circuit
- * Mechanical wear resistance: 1x10⁶ commutation cycles
- * Power of mechanical compression:
 - at closing: 20N
 - at opening: 8N
- * Operating temperature: -20 - +70°C
- * Humidity: 35 – 85%RH
- * Tightening moment of the joining conductors: 0.15Nm
- * Section of the conductor: 1x0.5; 1x0.75; 1x1; 1x1.5; 1x2.5mm²

Mounting:

- * to a flat metal or plastic surface with thickness: max 4mm
- * opening with size: Ø 22.5mm



Type	Description	Type of contacts	Rated current (A) at 400V	Colour	Note	Packing / Box (pcs)	Catalogue number
EL 2- BA 21	Button round with spring reverse	NO	6	black		20 / 300	401021
EL 2- BA 31		NO	6	green		20 / 300	401031
EL 2- BA 51		NO	6	yellow		20 / 300	401051
EL 2- BA 61		NO	6	blue		20 / 300	401061
EL 2- BA 42		NC	6	red		20 / 300	401042

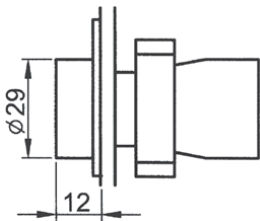

Type	Description	Type of contacts	Rated current (A) at 400V	Colour	Note	Packing / Box (pcs)	Catalogue number
EL 2- BP 31	Button round with spring reverse	NO	6	green	IP=65 Provided from silicon lid	20 / 300	401032
EL 2- BP 42		NC	6	red	IP=65 Provided from silicon lid	20 / 300	401043

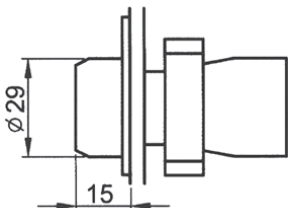

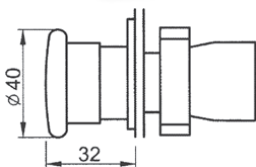
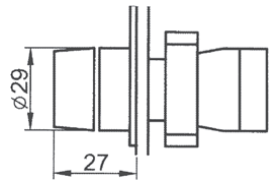
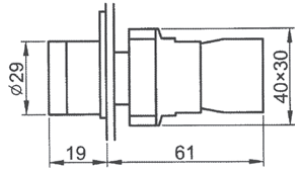

Type	Description	Voltage for the indicator	Rated current (A) at 400V	Colour	Note	Packing / Box (pcs)	Catalogue number
EL 2- BW3471	Button round with spring reverse and LED indicator	24V	6	red		20 / 200	401474
EL 2- BW3371		24V	6	green		20 / 200	401374
EL 2- BW3571		24V	6	yellow		20 / 200	401574
EL 2- BW3671		24V	6	blue		20 / 200	401674
EL 2- BW3471		110V	6	red		20 / 200	401473
EL 2- BW3371		110V	6	green		20 / 200	401373
EL 2- BW3571		110V	6	yellow		20 / 200	401573
EL 2- BW3671		110V	6	blue		20 / 200	401673
EL 2- BW3471		230V	6	red		20 / 200	401471
EL 2- BW3371		230V	6	green		20 / 200	401371
EL 2- BW3571		230V	6	yellow		20 / 200	401571
EL 2- BW3671		230V	6	blue		20 / 200	401671

Type	Description	Type of contacts	Rated current (A) at 400V	Colour	Note	Packing / Box (pcs)	Catalogue number
EL 2- BD 21	Switch with arrest	1NO	6	black	two-position	20 / 200	401421
EL 2- BD 33	Switch with arrest	2NO	6	black	three-position	20 / 200	401433

Type	Description	Type of contacts	Rated current (A) at 400V	Colour	Note	Packing / Box (pcs)	Catalogue number
EL 2- BC 42	Button with head "mushroom" type	1NC	6	red	spring reverse	15 / 150	401642

Type	Description	Type of contacts	Rated current (A) at 400V	Colour	Note	Packing / Box (pcs)	Catalogue number
EL 2- BS 545	Button with head "mushroom" type	1NC + 1NO	6	red	release with spinning	15 / 150	401545



Type	Description	Type of contacts	Rated current (A) at 400V	Colour	Note	Packing / Box (pcs)	Catalogue number
EL 2- BW8475	Button double	1NO+1NC	6		Green and red button + LED indicator	20 / 200	401845

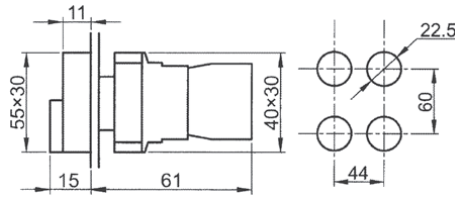

Type	Description	Type of contacts	Rated current (A) at 400V	Colour	Note	Packing / Box (pcs)	Catalogue number
EL 2- BG 21	Change-over switch with switch	1NO	6		two-position with switch	20 / 200	401121

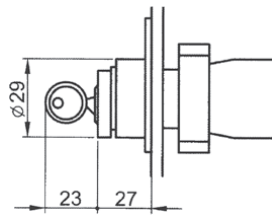

Type	Description	Un	Colour	Packing / Box (pcs)	Catalogue number
AD56-22-W-230	LED indication	230V AC	white	10 / 500	401123
AD56-22-W-110		110V AC	white	10 / 500	401111
AD56-22-W-24		24V AC/DC	white	10 / 500	401124
AD56-22-A-110		110V AC	amber	10 / 500	401211
AD56-22-A-24		24V AC/DC	amber	10 / 500	401224
AD56-22-A-230		230V AC	amber	10 / 500	401223
AD56-22-PG-230		230V AC	green	10 / 500	401323
AD56-22-PG-110		110V AC	green	10 / 500	401311
AD56-22-PG-24		24V AC/DC	green	10 / 500	401324
AD56-22-B-230		230V AC	blue	10 / 500	401523
AD56-22-B-110		110V AC	blue	10 / 500	401511
AD56-22-B-24		24V AC/DC	blue	10 / 500	401524
AD56-22-Y-230		230V AC	yellow	10 / 500	401723
AD56-22-Y-110		110V AC	yellow	10 / 500	401711
AD56-22-Y-24		24V AC/DC	yellow	10 / 500	401724
AD56-22-R-230		230V AC	red	10 / 500	401423
AD56-22-R-110	110V AC	red	10 / 500	401411	
AD56-22-R-24	24V AC/DC	red	10 / 500	401424	

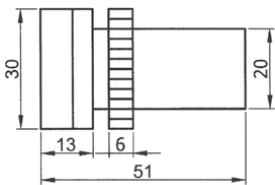

Type	Description	Type of contacts	Colour	Packing / Box (pcs)	Catalogue number
EL 02 - BE101	1	1 NO	green	100 / 1000	401001
EL 02 - BE102	2	1 NC	red	100 / 1000	401002



Type	Description	Ingress protecting rating	Overall dimensions (mm)			Type of the contact	Colour	Packing / Box (pcs)	Catalogue number
			L	H	W				
EL1-B134	switching on 0-1	IP44	68	68	50	1 NO	black	1 / 100	401134



Type	Description	Ingress protecting rating	Overall dimensions (mm)			Type of the contact	Colour	Packing / Box (pcs)	Catalogue number
			L	H	W				
EL1-B102	1 button with spring return	IP44	68	68	50	1 NO	green	1 / 100	401102
EL1-BP102	1 button with spring return	IP65	68	68	50	1 NO	green	1 / 100	401132



Type	Description	Ingress protecting rating	Overall dimensions (mm)			Type of the contact	Colour	Packing / Box (pcs)	Catalogue number
			L	H	W				
EL1-B213	2 buttons with spring return	IP44	104	68	50	1 NC 1 NO	1 - red 1 - green	1 / 100	401213
EL1-BP213	2 buttons with spring return	IP65	104	68	50	1 NC 1 NO	1 - red 1 - green	1 / 100	401233

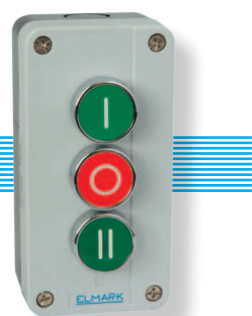

Type	Description	Ingress protecting rating	Overall dimensions (mm)			Type of the contact	Colour	Packing / Box (pcs)	Catalogue number
			L	H	W				
EL1-B339	3 buttons with spring return	IP44	134	68	50	1 NO 1 NC 1 NO	1 - green 1 - red 1 - green	1 / 50	401339
EL1-BP339	3 buttons with spring return	IP65	134	68	50	1 NO 1 NC 1 NO	1 - green 1 - red 1 - green	1 / 50	401349



Type	Description	Ingress protecting rating	Overall dimensions (mm)			Type of the contact	Colour	Packing / Box (pcs)	Catalogue number
			L	H	W				
EL1-B174	Emergency button with head "mushroom" type Ø40. Release through turning	IP44	68	68	50	1 NC	red	1 / 100	401174

These are devices used in control and indication systems adjusted for mounting in command boards and panels directly on DIN-rail. They are manufactured to commutate controlling circuits and to control the switching on or off executive mechanisms such as relays, contactors, etc. The signal lamps and indicators find broad application in all industrial fields. The devices endure short time current overload up to 20A, and normally they can commutate current up to 10A with their contact system. The connection to the contact terminals is through screw terminals to which operational conductors with section up to 2.5mm² can be joined. There are also designed buttons combined with lamps.

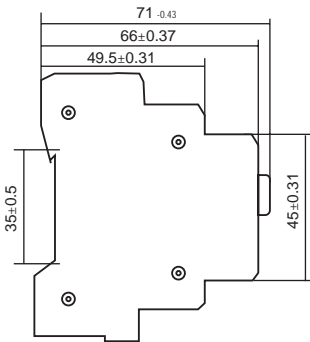

Documents corresponding to the product:
Standard EN 60947-1
EN 60 947-5-1 t

Technical data:

- * Insulation voltage: 660V; 50/60Hz
- * Impulse voltage wear resistance: 6000V;
- * Rated current: up to 10A (230V AC)
- * Short circuit protection: safety device 10A gG outside in the circuit
- * Rated consumed current (for indicators and buttons combined with indicators): <20mA
- * wear resistance (indicators): >2000h
- * Mechanical wear resistance (buttons): 1x10⁶ commutation cycles
- * Power of mechanical compression:
 - at closing: 20N
 - at opening: 8N
- * Operating temperature: -20 - +70°C
- * Humidity: 35 – 85%RH
- * Tightening moment of the joining conductors: 0.15Nm
- * Section of the conductor: 1x0.5; 1x0.75; 1x1; 1x1.5; 1x2.5mm²
- * Plastic: UV rays wear resistance

Mounting:

- * to a DIN-rail
- * Altitude: up to 2000m



Type	Description	Rated current (A) at 400V	Type of the contact	Colour	Packing / Box (pcs)	Catalogue number
ELB - BL - DIN	button	<10	2NO+ 1 NC	black	12 / 240	401505
ELB - BL - DIN	button	<10	1NO+ 2 NC	black	12 / 240	401506
ELB - G - DIN	button	<10	2NO+ 1 NC	green	12 / 240	401507
ELB - G - DIN	button	<10	1NO+ 2 NC	green	12 / 240	401508
ELB - Y - DIN	button	<10	2NO+ 1 NC	yellow	12 / 240	401509
ELB - Y - DIN	button	<10	1NO+ 2 NC	yellow	12 / 240	401510
ELB - R - DIN	button	<10	2NO+ 1 NC	red	12 / 240	401512
ELB - R - DIN	button	<10	1NO+ 2 NC	red	12 / 240	401513

Type	Description	Voltage (V)	Rated current (A) at 400V	Colour	Packing / Box (pcs)	Catalogue number
ELD - G - DIN	lamp	230V	<20	green	12 / 240	401500
ELD - R - DIN	lamp	230V	<20	red	12 / 240	401501
ELD - Y - DIN	lamp	230V	<20	yellow	12 / 240	401502
ELD - B - DIN	lamp	230V	<20	blue	12 / 240	401503
ELD - W - DIN	lamp	230V	<20	white	12 / 240	401504

Type	Description	Voltage (V)	Rated current (A) at 400V	Type of the contact	Colour	Packing / Box (pcs)	Catalogue number
ELBD - G - DIN	button + lamp	230V	<20	2NO+ 1 NC	green	12 / 240	401514
ELBD - G - DIN	button + lamp	230V	<20	1NO+ 2 NC	green	12 / 240	401515
ELBD - R - DIN	button + lamp	230V	<20	2NO+ 1 NC	red	12 / 240	401516
ELBD - R - DIN	button + lamp	230V	<20	1NO+ 2 NC	red	12 / 240	401517
ELBD - Y - DIN	button + lamp	230V	<20	2NO+ 1 NC	yellow	12 / 240	401518
ELBD - Y - DIN	button + lamp	230V	<20	1NO+ 2 NC	yellow	12 / 240	401519

Devices for telfer control MBP type

They represent different combinations of START and STOP buttons mounted in plastic boxes in different sizes. They are connected to the operating circuits of cranes or telfers and serve as a remote control of their movement. They are connected directly to the operating cable of the telfer and send commands directly to the executive mechanisms. They are designed to provide protection from dust and moisture IP65.

Technical data:

- * Supplying voltage: 230V; 50/60Hz
- * Consumed power: <5VA
- * Electrical wear resistance: 1x10⁵ cycles
- * Operating temperature: -10 +40°C
- * Dampness: 35 – 85% RH
- * Number of contacts: according to the number of the buttons
- * Commuting capacity: up to 6A
- * Plastic: UV rays wear resistance
- * IP code: IP65
- * Weight: according to the number of the contacts

Mounting:

- * directly to the control cable of the telfer (crane)

MBP-Axxxx — stop button type
 — button type – one-speed (x81) or two-speed (x91)
 — number of buttons



Type	Number of buttons	Contact block and scheme		Packing / Box (pcs)	Catalogue number
		Emergency	For the directions		
MBP-A281	2	-	NO+NC	1 / 20	46281
MBP-A291 two-speed	2	-	NO+NC	1 / 20	46291
MBP-A2813	2+1	emergency button	NO+NC	1 / 20	46283
MBP-A2813K	2+1	emergency button with switch	NO+NC	1 / 20	46283K
MBP-A2913 two-speed	2+1	emergency button	NO+NC	1 / 20	46294
MBP-A481	4	-	NO+NC	1 / 20	46481
MBP-A491 two-speed	4	-	NO+NC	1 / 20	46491
MBP-A4813	4+1	emergency button	NO+NC	1 / 20	46483
MBP-A4813K	4+1	emergency button with switch	NO+NC	1 / 20	46483K
MBP-A4913 two-speed	4+1	emergency button	NO+NC	1 / 20	46493
MBP-A681	6	-	NO+NC	1 / 20	46681
MBP-A691 two-speed	6	-	NO+NC	1 / 20	46691
MBP-A6813	6+1	emergency button	NO+NC	1 / 20	46683
MBP-A6813K	6+1	emergency button with switch	NO+NC	1 / 20	46683K
MBP-A6913 two-speed	6+1	emergency button	NO+NC	1 / 20	46693
MBP-A881	8	-	NO+NC	1 / 20	46881
MBP-A891 two-speed	8	-	NO+NC	1 / 20	46891
MBP-A8813	8+1	emergency button	NO+NC	1 / 20	46883
MBP-A8813K	8+1	emergency button with switch	NO+NC	1 / 20	46883K
MBP-A8913 two-speed	8+1	emergency button	NO+NC	1 / 20	46893

Warning lights and towers

The revolving warning lights and towers are devices intended for use as status indicators in the human-machine control systems. They are suitable for installation on control cabinets and panels or directly on machines. They are manufactured in different color combinations to attract attention of operators working in a given production sector. Warning lights and towers are widely used in almost any industrial branch. They can be mounted on movable components or such, creating potential danger and can warn all workers for a critical situation with their blinking light and siren. These devices are electrically connected through cables, protruding out of the lamp casing.



Technical Specification:

- * Rated voltage: 230V; 50/60 Hz;
- * Isolation voltage: 660V; 50/60 Hz;
- * Impulse voltage stability: 6000V
- * Rated power: see the tables below
- * Short circuit protection: 1A gG external fuse
- * Operating Temperature: - 20°C + 70°C
- * Humidity: 35 – 85% RH
- * Plastic cover: UV resistant polycarbonate not considered as being harmful to human health

Installation:

- * Warning lights are fixed to the respective machine body with the studs protruding from the light plastic casing.



Type	Description	Voltage (V)	Rated Power (W)	Colour	Packing / Box (pcs)	Catalogue number
LTE1101 - R	Warning light	12	10	Red	1 / 30	401525R
LTE1101 - G	Warning light	12	10	Green	1 / 30	401525G
LTE1101 - Y	Warning light	12	10	Yellow	1 / 30	401525Y
LTE1101J - R	Warning light + siren	12	11	Red	1 / 30	401526R
LTE1101J - G	Warning light + siren	12	11	Green	1 / 30	401526G
LTE1101J - Y	Warning light + siren	12	11	Yellow	1 / 30	401526Y
LTE1101 - R	Warning light	230	8	Red	1 / 30	402525R
LTE1101 - G	Warning light	230	8	Green	1 / 30	402525G
LTE1101 - Y	Warning light	230	8	Yellow	1 / 30	402525Y
LTE1101J - R	Warning light + siren	230	9	Red	1 / 30	402526R
LTE1101J - G	Warning light + siren	230	9	Green	1 / 30	402526G
LTE1101J - Y	Warning light + siren	230	9	Yellow	1 / 30	402526Y



Type	Description	Voltage (V)	Rated Power (W)	Colour	Packing / Box (pcs)	Catalogue number
LTE1161 - R	Warning light	12	35	Red	1 / 8	401527R
LTE1161 - G	Warning light	12	35	Green	1 / 8	401527G
LTE1161 - Y	Warning light	12	35	Yellow	1 / 8	401527Y
LTE1161 - R	Warning light	230	28	Red	1 / 8	402527R
LTE1161 - G	Warning light	230	28	Green	1 / 8	402527G
LTE1161 - Y	Warning light	230	28	Yellow	1 / 8	402527Y



Type	Description	Voltage (V)	Rated Power (W)	Colour	Packing / Box (pcs)	Catalogue number
LTA205 - 1	Tower / flashing	12	4		1 / 20	401528
LTA205 - 2	Tower / flashing	12	8	1 - Red	1 / 20	401529
LTA205 - 3	Tower / flashing	12	12	2 - Red/Green	1 / 20	401530
LTA205 - 3J	Tower / flashing + siren	12	12	3 - Red/Yellow/Green	1 / 20	401531
LTA205 - 5	Tower / flashing	12	18	3 - Red/Yellow/Green	1 / 20	401532
LTA205 - 1	Tower / flashing	230	6	5 - Red/Yellow/Green/Blue/Transparent	1 / 20	402528
LTA205 - 2	Tower / flashing	230	8	1 - Red	1 / 20	402529
LTA205 - 3	Tower / flashing	230	10	2 - Red/Green	1 / 20	402530
LTA205 - 3J	Tower / flashing + siren	230	11	3 - Red/Yellow/Green	1 / 20	402531
LTA205 - 5	Tower / flashing	230	14	5 - Red/Yellow/Green/Blue/Transparent	1 / 20	402532



Type	Description	Voltage (V)	Rated Power (W)	Sound level (dB)	Packing / Box (pcs)	Catalogue number
MS-290A	metal siren	230	60	100	1 / 24	401533
MS-290B	plastic siren	230	60	100	1 / 10	401541



Type	Description	Voltage (V)	Rated Power (W)	Sound level (dB)	Packing / Box (pcs)	Catalogue number
MS-390	siren	230	160	120	1 / 50	401534



Type	Description	Voltage (V)	Rated Power (W)	Sound level (dB)	Packing / Box (pcs)	Catalogue number
CB-4	alarm bell	12	-	85	1 / 50	401535
CB-4	alarm bell	24	-	85	1 / 50	401536
CB-4	alarm bell	110	-	85	1 / 50	401537
CB-4	alarm bell	230	-	85	1 / 50	401538



Type	Description	Voltage (V)	Rated Power (W)	Sound level (dB)	Packing / Box (pcs)	Catalogue number
FA-01	fire alarm	230	-	-	1 / 50	401540



Motion Infrared Sensor ST 07

Motion detector with built-in infrared sensor, sensitive to changes in the infrared spectre. Once the sensor detects movement within the detector's range, it sends a signal to the microprocessor to activate the system.

Applications:

- * Lights switching on at motion detection.
- * Security system activation at motion detection.

Technical Specifications:

- * Power Supply: 230VAC, 50/60 Hz
- * Rated Load: 1200W
- * Detection Range: 360°
- * Reach: 6 m (max. <24°)
- * Light Control: <10Lux
- * Time Setting: 5 sec., 1 min, 5 min, 8 min
- * Reaction to movement with speed of: 0.6 ~ 1.5 m/s
- * Operating Temperature: - 20 °C ~ 40 °C
- * Humidity: < 93% RH

Installation: ceiling mounting

Type	Packing / Box (pcs)	Catalogue number
ST 07	1 / 50	46DS400

Motion Infrared Sensor ST 01

Motion detector with built-in infrared sensor, sensitive to changes in the infrared spectre or to sound effects. Once the sensor detects movement within the detector's range, it sends a signal to the microprocessor to activate the system.

Applications:

- * Lights switching on at motion detection.
- * Security system activation at motion detection.

Technical Specifications:

- * Power Supply: 230VAC, 50/60 Hz
- * Rated Load: 500W
- * Detection Range: >140°
- * Reach: 12m (max. <24°)
- * Detection System:infrared radar
- * Light Control : < 2Lux~1000Lux
- * Time Setting: from 5 sec to 9 min
- * Reaction to movement with speed of: 0.6 ~ 1.5 m/s
- * Sound control sensitivity: adjustable 30db ~ 90dB
- * Installation: wall mounting 0.4~1.8m; mounting into round console box for concrete and brick
- * Humidity: < 93% RH



Type	Packing / Box (pcs)	Catalogue number
ST 01	1 / 100	46DS402

Motion Infrared Sensor ST 08

Motion detector with built-in infrared sensor, sensitive to changes in the infrared spectre or to sound effects. Once the sensor detects movement within the detector's range, it sends a signal to the microprocessor to activate the system. The sensor is intended for outdoor use.

Applications:

- * Lights switching on at motion detection.
- * Security system activation at motion detection.

Technical Specifications:

- * Power Supply: 230VAC, 50/60 Hz
- * Rated Load: 1200W
- * Detection Range: 180°
- * Reach: 12 m (max. <24°)
- * Detection System:infrared radar
- * Light Control:< 3Lux ~ daylight
- * Time Setting: 5 sec to 8 min
- * Reaction to movement with speed of: 0.6 ~ 1.5 m/s
- * Degree of Protection: IP44
- * Operating Temperature: - 20 °C ~ 40 °C
- * Humidity: < 93% RH
- * Installation: 0.5 ~ 3.5 m



Type	Packing / Box (pcs)	Catalogue number
ST 08	1 / 50	46DS403



Smoke Alarm ST82

Smoke alarm with photoelectric sensor. Whenever the sensor detects presence of smoke in the room as a result of fire, the photoelectric sensor sends a signal to the microprocessor to activate the alarm.

Applications:

- * Fire alarm activation at detecting smoke in the room.

Technical Specifications:

- * Power Supply: 230VAC, 50/60 Hz
- * Output Load: 10 mA
- * Alarm Sound: 85dB(3m)
- * Operating Temperature: - 10 oC ~ 40 oC
- * Humidity: < 93% RH
- * Low Voltage Alarm: 5.5V-6.2V
- * Support Battery: 7 ~ 15 days
- * Installation: ceiling mounting

Type	Packing / Box (pcs)	Catalogue number
ST 82	1	46DS404



Smoke Alarm ST85-2

Smoke alarm with photoelectric sensor. Whenever the sensor detects presence of smoke in the room as a result of fire, the photoelectric sensor sends a signal to the microprocessor to activate the alarm. Suitable for incorporation in building fire and security systems.

Applications:

- * Fire alarm activation at detecting smoke in the room.

Technical Specifications:

- * Power Supply: 12/24 V DC
- * Output Load: 17 mA
- * Alarm Sound: 85dB(3m)
- * Operating Temperature: - 5 oC ~ 40 oC
- * Humidity: < 93% RH
- * Installation: ceiling mounting

Type	Packing / Box (pcs)	Catalogue number
ST 85-2	1	46DS405

Bases for high power safety devices

Documents corresponding to the product:
Standard EN 60269-1

The series bases for high power safety device is manufactured of permittivity alloy with mounted contact jaws of electrolytic copper supplied with special springs for contact compression and easy fuse links taking out. All current leading parts are connected to inlet outlet terminals with bolts; the terminals also end with bolts, to which the power supply conductors are connected. The bases are offered in five type sizes corresponding to the five types of fuse links.

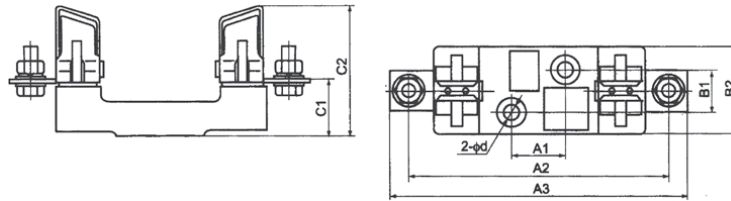

Base type	Overall dimensions (mm)							
	A1	A2	A3	B1	B2	C1	C2	Ød
SIST00	25	100	120	-	30	25	60	7.5
SIST 0	25	150	170	-	30	37	72	7.5
SIST1	25	175	200	30	58	38	84	10.5
SIST2	25	200	225	30	60	38	100	10.5
SIST3	25	210	250	30	60	40	105	10.5

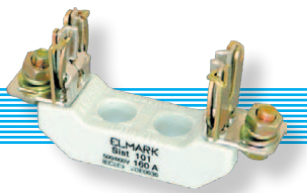

Base type	Fuse link type	Rated current (A)	Rated voltage Un (V)	Weight (gr)	Packing / Box (pcs)	Catalogue number
SIST00	NT 00	up to 160	600	193	5 / 120	12001
SISP00	NT 00	up to 160	600	215	5 / 120	12001P

Remark : Fuse bases SISP are made of porcelain



Base type	Fuse link type	Rated current (A)	Rated voltage Un (V)	Weight (gr)	Packing / Box (pcs)	Catalogue number
SIST0	NT 0	up to 160	600	295	3 / 54	12010
SISP0	NT 0	up to 160	600	319	3 / 54	12010P

Remark : Fuse bases SISP are made of porcelain

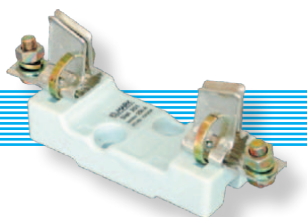

Base type	Fuse link type	Rated current (A)	Rated voltage Un (V)	Weight (gr)	Packing / Box (pcs)	Catalogue number
SIST1	NT 1	up to 250	600	550	3 / 36	12100
SISP1	NT 1	up to 250	600	550	3 / 36	12100P

Remark : Fuse bases SISP are made of porcelain

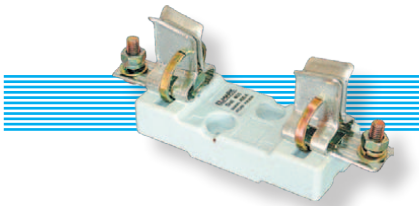

Base type	Fuse link type	Rated current (A)	Rated voltage Un (V)	Weight (gr)	Packing / Box (pcs)	Catalogue number
SIST2	NT 2	up to 400	600	770	1 / 20	12200
SISP2	NT 2	up to 400	600	810	1 / 20	12200P

Remark : Fuse bases SISP are made of porcelain

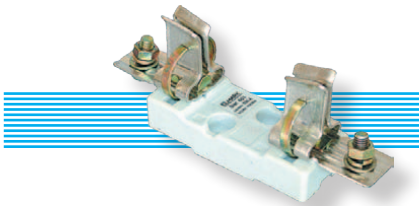

Base type	Fuse link type	Rated current (A)	Rated voltage Un (V)	Weight (gr)	Packing / Box (pcs)	Catalogue number
SIST3	NT 3	up to 630	600	965	1 / 15	12300
SISP3	NT 3	up to 630	600	987	1 / 20	12300P

Remark : Fuse bases SISP are made of porcelain

Documents corresponding to the product:
Standard EN 60269-1
EN 60269-2

Fuse links for high power safety devices

The series fuse links for high power safety devices is designed for short circuit protection. They are distinguished with high speed of operation and high reliability. The element is a ceramic (porcelain) body filled with fine quartz sand for voltaic arc lowering. In the ceramic body is mounted a fusible, specially profiled wafer connecting the current leading terminals. These terminals are manufactured of copper alloy with special nickel coating and have the form of knives to provide more contact surface. The fuse links correspond to "gL – gG" class which means that they are with common function and normal response time.

NH Fuses

Two operating classes of NH Fuses are available:

- * Operating class gL/gG – general purpose, line protection, slow acting
- * Operating class "aM" – fast acting, suitable for motor overload and short circuit protection

Technical data:

- * Rated voltage: 500V
- * Rated short circuit current: 120 kAeff
- * IP code: IP 00
- * Ambient temperature: -5 to +55°C
- * Altitude: up to 2000m

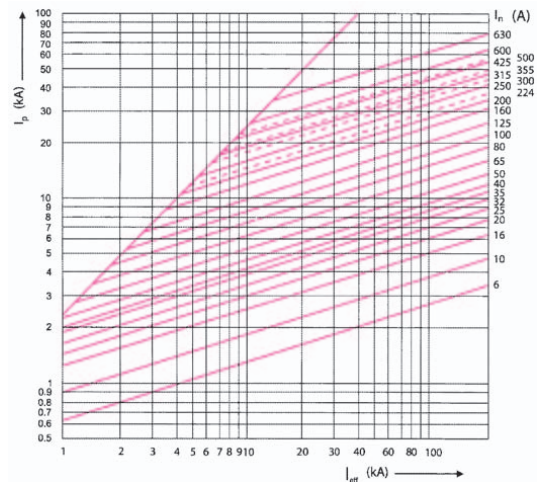
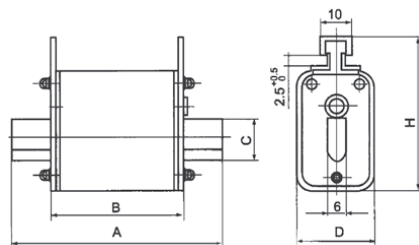

Base type	Overall dimensions (mm)				
	A	B	C	D	H
NT00	78	40	15	29	56.5
NT 0	125	68	15	29	56.5
NT1	135	68	21	48	62
NT 2	150	68	27	58	72
NT 3	150	68	33	67	84.5

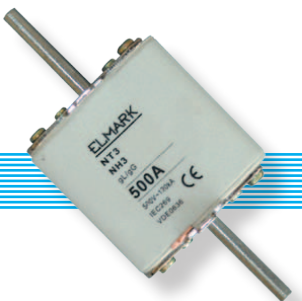

Type	In (A)	Un (V)	Packing / Box (pcs)	Catalogue number class gL-gG
NT00	16	500,600	3 / 120	10001
NT00	25	500,600	3 / 120	10002
NT00	32	500,600	3 / 120	10003
NT00	40	500,600	3 / 120	10004
NT00	50	500,600	3 / 120	10005
NT00	63	500,600	3 / 120	10006
NT00	80	500,600	3 / 120	10008
NT00	100	500,600	3 / 120	10009
NT00	125	500,600	3 / 120	10012
NT00	160	500,600	3 / 120	10016

Type	In (A)	Un (V)	Packing / Box (pcs)	Catalogue number class gL-gG
NT0	16	500,600	3 / 90	10015
NT0	25	500,600	3 / 90	10025
NT0	32	500,600	3 / 90	10032
NT0	40	500,600	3 / 90	10040
NT0	50	500,600	3 / 90	10050
NT0	63	500,600	3 / 90	10063
NT0	80	500,600	3 / 90	10080
NT0	100	500,600	3 / 90	10090
NT0	125	500,600	3 / 90	10092
NT0	160	500,600	3 / 90	10096

Type	In (A)	Un (V)	Packing / Box (pcs)	Catalogue number class gL-gG
NT1	80	500,600	3 / 54	10108
NT1	100	500,600	3 / 54	10110
NT1	125	500,600	3 / 54	10112
NT1	160	500,600	3 / 54	10116
NT1	200	500,600	3 / 54	10120
NT1	225	500,600	3 / 54	10122
NT1	250	500,600	3 / 54	10125

Type	In (A)	Un (V)	Packing / Box (pcs)	Catalogue number class gL-gG
NT2	160	500,600	1 / 30	10216
NT2	200	500,600	1 / 30	10220
NT2	250	500,600	1 / 30	10225
NT2	315	500,600	1 / 30	10231
NT2	400	500,600	1 / 30	10240

Type	In (A)	Un (V)	Packing / Box (pcs)	Catalogue number class gL-gG
NT3	500	500,600	1 / 24	10350
NT3	630	500,600	1 / 24	10363

Isolating switches

Documents corresponding to the product:
 Standard EN 60947-1;
 EN 60947-3

Designed in two types – horizontal and vertical. They represent a combination of low voltage isolating switch and high power safety devices mounted in a common plastic corpus. They are used for low voltage distribution boards and complete transformer substations (CTS) where visible circuit distribution is necessary. They provide safety and convenience at fuse links change. The plastic corpus increases the IP code and the plastic lid provides simultaneous circuits switching on/off. The lid allows easy removing which is additional measure at repairs. The vertical isolating switches are mounted directly to the power supply rails which enables the exploitation and improves the safety of the staff.

Technical data:

- * Rated voltage: 500V
- * Rated short circuit current: according to the mounted fuse links
- * Number of poles: 3
- * Impulse voltage wear resistance: 8kV
- * Mechanical wear resistance: 3000 cycles
- * IP code: IP 40
- * Plastic: UV rays wear resistance
- * Ambient temperature: -5 to +55°C
- * Altitude: up to 2000m

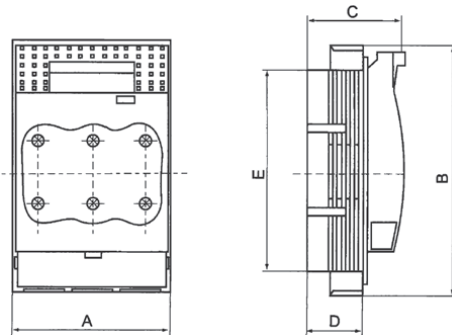

Base type	Overall dimensions (mm)				
	A	B	C	D	E
THB - 160	105	160	85	45	100
THB - 250	185	220	111	66	180
THB - 400	210	260	130	88	205
THB - 630	256	270	140	94.5	245

Type	In (A)	Un (V)	Fuse link size	Packing / Box (pcs)	Catalogue number
THB	160	500, 660	NT00	1 / 18	44801
THB	250	500, 660	NT1	1 / 6	44802
THB	400	500, 660	NT2	1 / 4	44803
THB	630	500, 660	NT3	1/4	44804

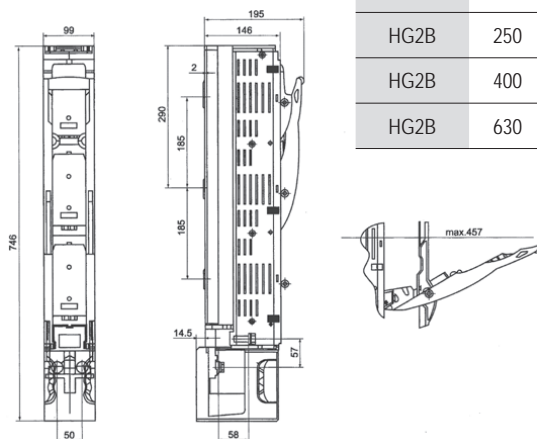

Type	In (A)	Un (V)	Fuse link size	Packing / Box (pcs)	Catalogue number
HG2B	160	500, 660	NT00	1 / 4	44805
HG2B	250	500, 660	NT1	1 / 4	44806
HG2B	400	500, 660	NT2	1 / 4	44807
HG2B	630	500, 660	NT3	1 / 4	44808



Documents corresponding to the product:
Standard EN 60269-2; IEC269-2

The series of switch disconnectors are developed for short-circuit protection. They have a high speed of start and high reliability. They have a plastic body of inflammable plastics adapted for mounting on a DIN rail, where a porcelain round plug, which is filled with fine quartz sand for extinguishing the electric arc. LED indicator is mounted on the front panel to show fuse link condition. In this ceramic body is mounted melting, specifically profiled plate, which connects the input power terminals. These terminals are produced from copper alloy with especially laid nickel layer and contact with the projecting bolts from the plastic body. There are offered two types of insertions according to the degree of quick operation: normally quickly operating ones – class “gG” and over quickly operating ones class “aR”. Suitable for DC system.

Technical data:

- * Rated voltage: 500V
- * Insulation voltage: >2500V
- * Rated current on short-circuit: 100 kA
- * Direct mounting to the load
- * Two insulated points to the load
- * Protection rate: IP 44
- * Cross-section of the supply conductors: up to 35mm²
- * Environmental temperature: -5° to +55°C
- * Utilization category: AC - 20B
DC - 20B
- * Altitude: up to 2000m

Overall dimensions

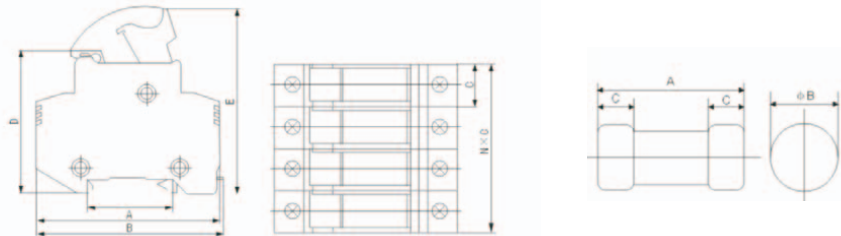

Base type	Number of poles	Rated current (A)	Type of the fuse	Base dimensions (mm)					Packing / Box (pcs)	Catalogue number
				A	B	C	D	E		
1PRT18 - 32x	1P	32	xxG1038	80	82	18	60	78	12 / 240	10RT1831
1NRT18 - 32x	1P+N	32	xxG1038	80	82	36	60	78	12 / 240	10RT18311
2PRT18 - 32x	2P	32	xxG1038	80	82	36	60	78	12 / 240	10RT1832
3PRT18 - 32x	3P	32	xxG1038	80	82	54	60	78	12 / 240	10RT1833
3NRT18 - 32x	3P+N	32	xxG1038	80	82	72	60	78	12 / 240	10RT18331
1PRT18 - 63x	1P	63	xxG1451	103	105	27	80	110	6 / 108	10RT1861
1NRT18 - 63x	1P+N	63	xxG1451	103	105	54	80	110	6 / 108	10RT18611
2PRT18 - 63x	2P	63	xxG1451	103	105	54	80	110	6 / 108	10RT1862
3PRT18 - 63x	3P	63	xxG1451	103	105	81	80	110	6 / 108	10RT1863
3NRT18 - 63x	3P+N	63	xxG1451	103	105	108	80	110	6 / 108	10RT18631

Type of the fuse class gG	Voltage (V)	Rated current (A)	Size of the fuse A x ØB x C	Packing / Box (pcs)	Catalogue number
01G1038	500	1	38xØ10.3x10mm	10 / 2000	10G10381
02G1038	500	2	38xØ10.3x10mm	10 / 2000	10G10382
04G1038	500	4	38xØ10.3x10mm	10 / 2000	10G10384
06G1038	500	6	38xØ10.3x10mm	10 / 2000	10G10386
10G1038	500	10	38xØ10.3x10mm	10 / 2000	10G103810
16G1038	500	16	38xØ10.3x10mm	10 / 2000	10G103816
20G1038	500	20	38xØ10.3x10mm	10 / 2000	10G103820
25G1038	500	25	38xØ10.3x10mm	10 / 2000	10G103825
32G1038	500	32	38xØ10.3x10mm	10 / 2000	10G103832
40G1451	500	40	51xØ14.3x12mm	10 / 1000	10G145140
50G1451	500	50	51xØ14.3x12mm	10 / 1000	10G145150
63G1451	500	63	51xØ14.3x12mm	10 / 1000	10G145163





Bell

Used for sound signalization in housing and industrial buildings.

* Sound level: 70 dB

Consumption:

-3.6VA for power supply 8 -12V

-5VA for power supply 230V

* Mounting on DIN-rail

Type	Un (V)	Packing / Box (pcs)	Catalogue number
Bell	8-12	1 / 17 170	5012
Bell	230	1 / 17 170	5220



Bell transformer

Modified for power supply of bells and other signal devices with alternating voltage 8V, 12V, 24V and capacity up to 3.8A.

* The voltage of the primary winding voltage is 230V

* Mounting on DIN-rail

Type	Packing / Box (pcs)	Catalogue number
Bell transformer	1 / 80	5001

ELECTRICAL SWITCHES AND SOCKETS

ELECTRICAL SWITCHES AND SOCKETS

EL[®]MARK

ELECTRICAL SWITCHES AND SOCKETS



ELECTRICAL SWITCHES AND SOCKETS

Electrical switches and sockets

RHYME

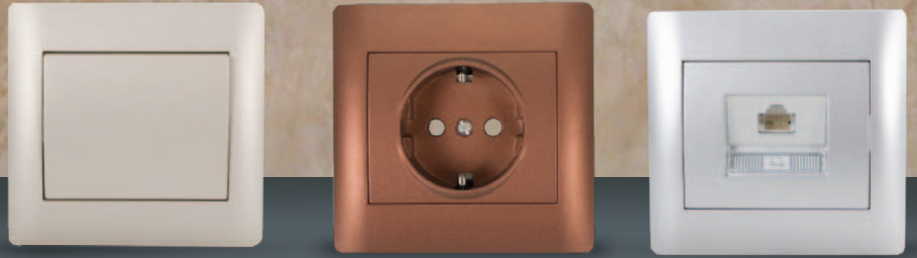
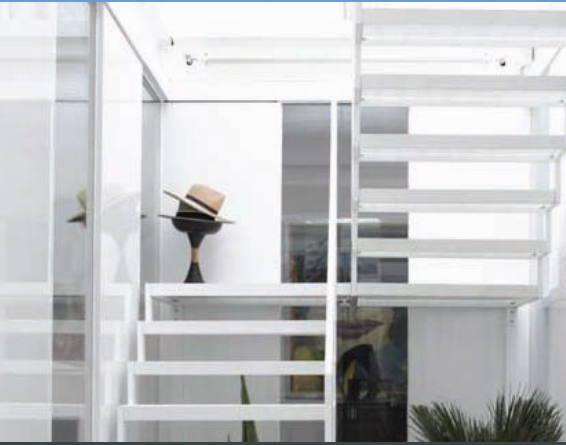

Packing: 10/100 pcs
Rated Current: 10A



Type	White metallic	Champagne metallic	Gold metallic	Grey metallic	Graphite metallic	Coffee metallic
1 button 1 way switch	11011	11012	11013	11014	11015	11016
1 button 2 way switch	11021	11022	11023	11024	11025	11026

Packing: 10/100 pcs
Rated Current: 10A



Type	White metallic	Champagne metallic	Gold metallic	Grey metallic	Graphite metallic	Coffee metallic
2 buttons 1 way switch	11041	11042	11043	11044	11045	11046

Packing: 10/100 pcs
Rated Current: 10A



Type	White metallic	Champagne metallic	Gold metallic	Grey metallic	Graphite metallic	Coffee metallic
door bell switch	11181	11182	11183	11184	11185	11186

Packing: 10/100 pcs
Power: 500W



Type	White metallic	Champagne metallic	Gold metallic	Grey metallic	Graphite metallic	Coffee metallic
dimmer switch	11191	11192	11193	11194	11195	11196

Packing: 10/100 pcs
Rated Current: 16A



Type	White metallic	Champagne metallic	Gold metallic	Grey metallic	Graphite metallic	Coffee metallic
German type socket	11211	11212	11213	11214	11215	11216
French type socket	11211F	11212F	11213F	11214F	11215F	11216F



Packing:
10/100 pcs

Type	White metallic	Champagne metallic	Gold metallic	Grey metallic	Graphite metallic	Coffee metallic
TV socket	11251	11252	11253	11254	11255	11256



Packing:
10/100 pcs

Type	White metallic	Champagne metallic	Gold metallic	Grey metallic	Graphite metallic	Coffee metallic
Phone socket	11261	11262	11263	11264	11265	11266



Packing:
10/100 pcs

Type	White metallic	Champagne metallic	Gold metallic	Grey metallic	Graphite metallic	Coffee metallic
Computer socket	11281	11282	11283	11284	11285	11286



Packing:
10/100 pcs

Type	White metallic	Champagne metallic	Gold metallic	Grey metallic	Graphite metallic	Coffee metallic
Key card power switch	11331	11332	11333	11334	11335	11336



Packing:
20/200 pcs

Type	White metallic	Champagne metallic	Gold metallic	Grey metallic	Graphite metallic	Coffee metallic
Double panel	11551	11552	11553	11554	11555	11556



Packing:
15/150 pcs

Type	White metallic	Champagne metallic	Gold metallic	Grey metallic	Graphite metallic	Coffee metallic
Triple panel	11661	11662	11663	11664	11665	11666



Packing: 10/100 pcs
Rated Current: 10A

Type	White metallic	Champagne metallic	Gold metallic	Grey metallic	Graphite metallic	Coffee metallic
Push light switch	11181C	11182C	11183C	11184C	11185C	11186C



Packing: 10/100 pcs
Rated Current: 10A

Type	White metallic	Champagne metallic	Gold metallic	Grey metallic	Graphite metallic	Coffee metallic
door bell switch with name card	11181B	11182B	11183B	11184B	11185B	11186B

Electrical switches and sockets

SPLENDOR

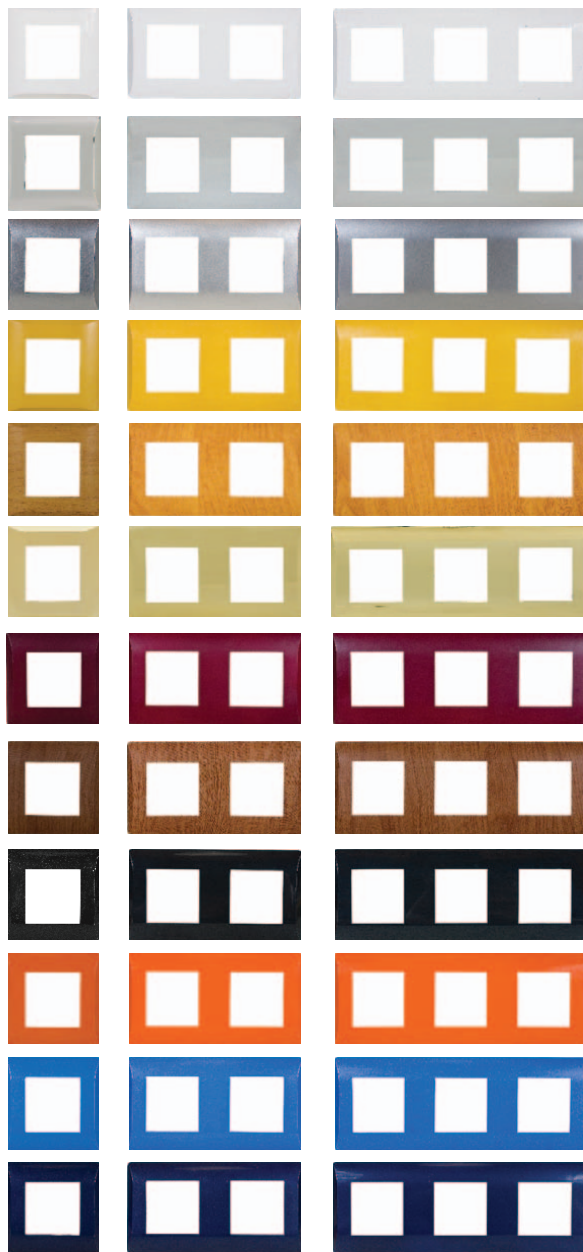

Colour	WHITE			
Type	single	single with cover	double	triple
Catalogue №	06301	0629	06311	06321

Colour	CHROME		
Type	single	double	triple
Catalogue №	063010	063110	063210

Colour	SILVER GRAY		
Type	single	double	triple
Catalogue №	06302	06312	06322

Colour	YELLOW		
Type	single	double	triple
Catalogue №	06304	06314	06324

Colour	PEAR-TREE		
Type	single	double	triple
Catalogue №	06305	06315	06325

Colour	GOLDEN		
Type	single	double	triple
Catalogue №	063011	063111	063211

Colour	BORDO		
Type	single	double	triple
Catalogue №	06307	06317	06327

Colour	CHERRY-TREE		
Type	single	double	triple
Catalogue №	06306	06316	06326

Colour	BLACK			
Type	single	single with cover	double	triple
Catalogue №	06303	1629	06313	06323

Colour	ORANGE		
Type	single	double	triple
Catalogue №	063012	063112	063212

Colour	LIGHT BLUE		
Type	single	double	triple
Catalogue №	06308	06318	06328

Colour	DARK BLUE		
Type	single	double	triple
Catalogue №	06309	06319	06329

Packing: single: 30/300 pcs / single with cover: 20/200 pcs / double: 20/200 pcs / triple: 15/150 pcs



Type	Rated current In (A)	Colour	Packing (pcs)	Catalogue number
one button one way switch	10	white	10/100	0601
	10	dark grey	10/100	1601
one button two way switch	10	white	10/100	0602
	10	dark grey	10/100	1602
one button cross switch	10	white	10/100	0603
	10	dark grey	10/100	1603



Type	Rated current In (A)	Colour	Packing (pcs)	Catalogue number
two buttons one way switch	10	white	10/100	0610
	10	dark grey	10/100	1610
two buttons one way switch with light	10	white	10/100	0612
	10	dark grey	10/100	1612
two buttons two way switch	10	white	10/100	0611
	10	dark grey	10/100	1611



Type	Rated current In (A)	Colour	Packing (pcs)	Catalogue number
German type socket	16	white	10/100	0616
	16	dark grey	10/100	1616
French type socket	16	white	10/100	0616F
	16	dark grey	10/100	1616F



Type	Rated current In (A)	Colour	Packing (pcs)	Catalogue number
one button one way switch with light	10	white	10/100	0606
	10	dark grey	10/100	1606
one button two way switch with light	10	white	10/100	0607
	10	dark grey	10/100	1607



Type	Rated current In (A)	Colour	Packing (pcs)	Catalogue number
Push light switch	10	white	10/100	0605
	10	dark grey	10/100	1605
Door bell switch with light	10	white	10/100	0609
	10	dark grey	10/100	1609



Type	Power (W)	Colour	Packing (pcs)	Catalogue number
Dimmer switch	600	white	10/100	0618
	600	dark grey	10/100	1618
Fan speed switch	500	white	10/100	0619
	500	dark grey	10/100	1619



Type	Colour	Packing (pcs)	Catalogue number
TV socket	white	10/100	0621
	dark grey	10/100	1621



Type	Colour	Packing (pcs)	Catalogue number
Phone socket	white	10/100	0623
	dark grey	10/100	1623
Phone socket double	white	10/100	06232
	dark grey	10/100	16232
Computer socket	white	10/100	0624
	dark grey	10/100	1624



Type	Rated current In (A)	Colour	Packing (pcs)	Catalogue number
German type socket (double)	16	white	10/100	0637
Key card power switch	10	white	10/100	0633
	10	dark grey	10/100	1633



Electrical switches and sockets

LIFE STYLE



Colour	WHITE					
Type	single	double	triple	quadruple	sixfold	
Catalogue №	34601	34613	34625	34637	34660	



Colour	CHROME					
Type	single	double	triple	quadruple	sixfold	
Catalogue №	34609	34621	34633	34645	-	



Colour	SILVER GRAY					
Type	single	double	triple	quadruple	sixfold	
Catalogue №	34610	34622	34634	34646	34662	



Colour	YELLOW					
Type	single	double	triple	quadruple	sixfold	
Catalogue №	34602	34614	34626	34638	-	



Colour	PEAR-TREE					
Type	single	double	triple	quadruple	sixfold	
Catalogue №	34611	34623	34635	34647	-	



Colour	GOLDEN					
Type	single	double	triple	quadruple	sixfold	
Catalogue №	34608	34620	34632	34644	-	



Colour	BORDO					
Type	single	double	triple	quadruple	sixfold	
Catalogue №	34606	34618	34630	34642	-	



Colour	CHERRY-TREE					
Type	single	double	triple	quadruple	sixfold	
Catalogue №	34162	34624	34636	34648	-	



Colour	DARK GREY					
Type	single	double	triple	quadruple	sixfold	
Catalogue №	34607	34619	34631	34643	34661	



Colour	GREEN					
Type	single	double	triple	quadruple	sixfold	
Catalogue №	34603	34615	34627	34639	-	



Colour	LIGHT BLUE					
Type	single	double	triple	quadruple	sixfold	
Catalogue №	34605	34617	34629	34641	-	



Colour	DARK BLUE					
Type	single	double	triple	quadruple	sixfold	
Catalogue №	34604	34616	34628	34640	-	

Packing: single : 40/480 pcs double : 40/480 pcs triple : 40/480 pcs quadruple : 35/420 pcs sixfold : 35/420 pcs



Type	Rated current In (A)	Colour	Packing (pcs)	Catalogue number
one button one way switch	16	white	4 / 48 / 960	20501
	16	dark grey	4 / 48 / 960	21501
one button cross switch	16	white	4 / 48 / 960	20579
	16	dark grey	4 / 48 / 960	21579



Type	Rated current In (A)	Colour	Packing (pcs)	Catalogue number
one button two way switch	16	white	4 / 48 / 960	20506
	16	dark grey	4 / 48 / 960	21506
one button two way switch with light	16	white	4 / 48 / 960	20507
	16	dark grey	4 / 48 / 960	21507



Type	Rated current In (A)	Colour	Packing (pcs)	Catalogue number
door bell switch with light	10	white	4 / 48 / 960	20510A
	10	dark grey	4 / 48 / 960	21510A
push light switch with light	10	white	4 / 48 / 960	20510B
	10	dark grey	4 / 48 / 960	21510B



Type	Rated current In (A)	Colour	Packing (pcs)	Catalogue number
curtain switch	10	white	4 / 48 / 960	20521
	10	dark grey	4 / 48 / 960	21521



Type	Power (W)	Colour	Packing (pcs)	Catalogue number
dimmer switch	500	white	8 / 48 / 960	20803
	500	dark grey	8 / 48 / 960	21803
fan speed switch	500	white	8 / 48 / 960	20803A
	500	dark grey	8 / 48 / 960	21803A



Type	Power (VA)	Colour	Packing (pcs)	Catalogue number
bell 230V	8	white	8 / 48 / 960	20616
	8	dark grey	8 / 48 / 960	21616



Type	Rated current In (A)	Colour	Packing (pcs)	Catalogue number
German type socket	16	white	4 / 24 / 480	20265
	16	dark grey	4 / 24 / 480	21265
French type socket	16	white	4 / 24 / 480	20265F
	16	dark grey	4 / 24 / 480	21265F



Type	Rated current In (A)	Colour	Packing (pcs)	Catalogue number
Italian standard multi socket	16	white	4 / 48 / 960	20203
	16	dark grey	4 / 48 / 960	21203



Type	Rated current In (A)	Colour	Packing (pcs)	Catalogue number
TV socket	-	white	4 / 48 / 960	20228
	-	dark grey	4 / 48 / 960	21228
Satellite socket	-	white	4 / 48 / 960	30301
	-	dark grey	4 / 48 / 960	31301



Type	Rated current In (A)	Colour	Packing (pcs)	Catalogue number
phone socket	RG 11	white	4 / 48 / 960	20251
	RG 11	dark grey	4 / 48 / 960	21251
computer socket	RG 45	white	4 / 48 / 960	20266
	RG 45	dark grey	4 / 48 / 960	21266



Type	Rated current In (A)	Colour	Packing (pcs)	Catalogue number
decorative cover	-	white	10 / 2000	20056
	-	dark grey	10 / 2000	21056





Plastic cable trunking CT2 for switches and sockets

Type	Size (mm)	Length (m)	Colour	Packing (m)	Catalogue number
PLASTIC CABLE TRUNKING CT2 FOR SWITCHES AND SOCKETS	100x35	2	white	24	56210035M
PLASTIC CABLE TRUNKING CT2 FOR SWITCHES AND SOCKETS	100x50	2	white	16	56210050M

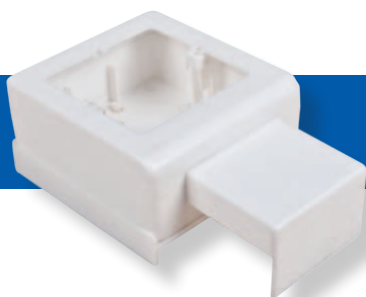

Single side box

Type	Used for cable trunking	Colour	Packing (pcs)	Catalogue number
SINGLE SIDE BOX	12x12	white	6	56212222
SINGLE SIDE BOX	15x10	white	6	56212222
SINGLE SIDE BOX	16x16	white	6	56212222
SINGLE SIDE BOX	25x16	white	6	56212222
SINGLE SIDE BOX	25x25	white	6	56212222
SINGLE SIDE BOX	40x16	white	6	56212222
SINGLE SIDE BOX	40x25	white	6	56212222
SINGLE SIDE BOX	40x40	white	6	56212222

Note: The mounting of switches and sockets should be made with additional screws - not included in the box set.

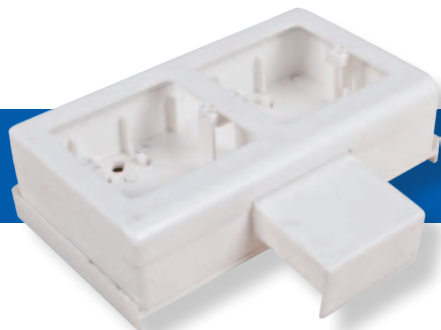

Double side box

Type	Used for cable trunking	Colour	Packing (pcs)	Catalogue number
DOUBLE SIDE BOX	12x12	white	3	56212223
DOUBLE SIDE BOX	15x10	white	3	56212223
DOUBLE SIDE BOX	16x16	white	3	56212223
DOUBLE SIDE BOX	25x16	white	3	56212223
DOUBLE SIDE BOX	25x25	white	3	56212223
DOUBLE SIDE BOX	40x16	white	3	56212223
DOUBLE SIDE BOX	40x25	white	3	56212223
DOUBLE SIDE BOX	40x40	white	3	56212223

Note: The mounting of switches and sockets should be made with additional screws - not included in the box set.



Separator

Type	Length (m)	Used for cable trunking	Colour	Packing (pcs)	Catalogue number
SEPARATOR 40	2	60x40	white	40	56261111
SEPARATOR 40	2	80x40	white	40	56261111
SEPARATOR 40	2	100x40	white	40	56261111
SEPARATOR 60	2	60x60	white	40	56261112
SEPARATOR 60	2	80x60	white	40	56261112
SEPARATOR 60	2	100x60	white	40	56261112

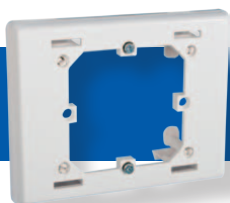

Frames

Type	Used for cable trunking	Colour	Packing (pcs)	Catalogue number
FRAME SINGLE	100x50	white	5	562100444
FRAME DOUBLE	100x50	white	5	562100445
FRAME TRIPLE	100x50	white	5	562100446

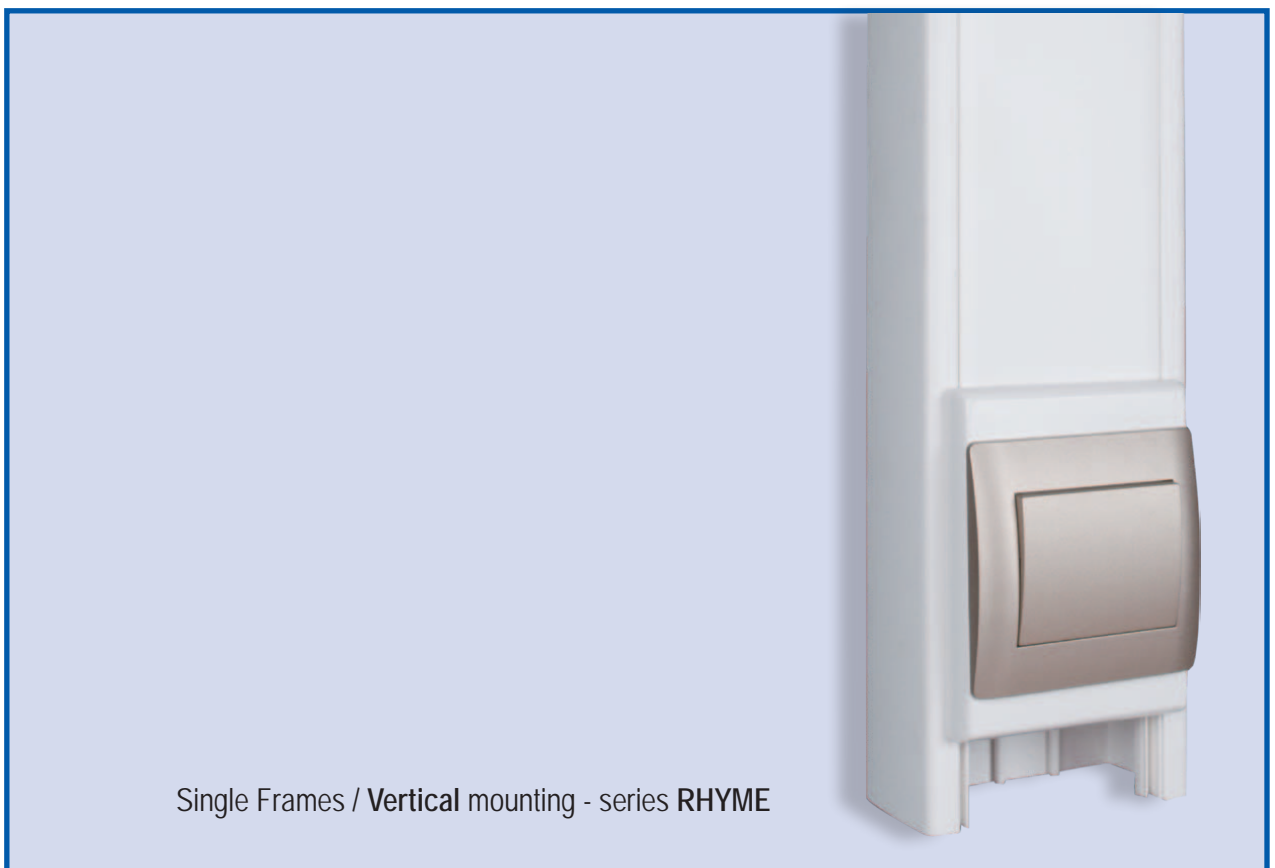



German type socket waterproof with transparent cover

Type	IP	Packing (pcs)	Catalogue number
Single	44	120	19221304



German type socket waterproof with transparent cover

Type	IP	Packing (pcs)	Catalogue number
Double	44	60	1922100311



German type socket waterproof with transparent cover

Type	IP	Packing (pcs)	Catalogue number
Triple	44	50	1922100312



German type socket waterproof with white cover

Type	IP	Packing (pcs)	Catalogue number
Single	44	120	1922130101



German type socket waterproof with white cover

Type	IP	Packing (pcs)	Catalogue number
Double	44	60	1922100307



German type socket waterproof with white cover

Type	IP	Packing (pcs)	Catalogue number
Triple	44	50	1922100309



Switch - waterproof

Type	IP	Packing (pcs)	Catalogue number
One way switch	44	120	1922130104
One button two way switch	44	120	1922130106



Switch - waterproof

Type	IP	Packing (pcs)	Catalogue number
Two buttons one way switch	44	120	1922130105



Switch - waterproof

Type	IP	Packing (pcs)	Catalogue number
Push light switch/door bell switch	44	120	1922130107



Surface mounting box - for LIFE STYLE series

Type	Packing (pcs)	Catalogue number
double	5 / 250	2702
triple	5 / 200	2703
quadruple	5 / 150	2704



Watertight box - for LIFE STYLE series

Type	IP	Packing (pcs)	Catalogue number
triple	44	1 / 100	22451A
quadruple	44	1 / 100	22461A



Frame - for LIFE STYLE series

Type	Packing (pcs) box / carton	Catalogue number
double frame	10 / 400	24262
triple frame	10 / 400	24201
quadruple frame	10 / 400	24202
sixfold frame	10 / 200	24206LF

* Single switch or socket use triple frame



Console box for brick and concrete - for LIFE STYLE series

Type	Packing (pcs)	Catalogue number
triple	10 / 300	24203
quadruple	10 / 200	71304
sixfold	10 / 200	68206

* Single, double and triple switch or socket use triple console



Console box for plasterboard

Type	Packing (pcs)	Catalogue number
triple	160	24205
quadruple	150	24206

* Single, double and triple switch or socket use triple console



Waterproof junction boxes

Plastic junction boxes with different shapes and dimensions. Designed for cable lines extension or tapping at cable installations laying. Made of ABS material with openings for input - output conductors, with rubber gasket to provide the corresponding IP rate. Resistant to chemical, thermal and UV rays. Direct wall mounting with screws.

Documentation corresponding to the product:
Standard: EN 60670-1

- Technical data:
 * Rated voltage: up to 1000V
 * Material: ABS
 * IP rate: IP 44/54

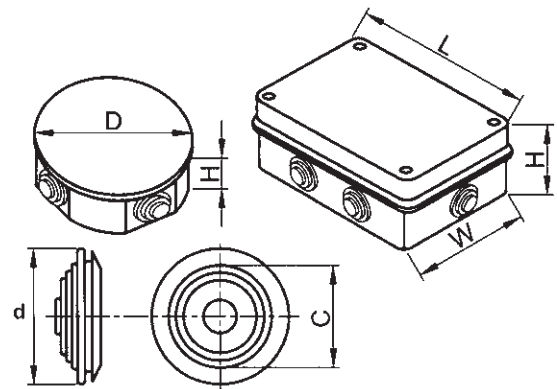

Box type	Box dimensions (mm)				Gasket dimensions (mm)		Ingress protection rating IP	Packing / Box	Catalogue number
	D	L	W	H	d	C			
WB50/50	50	-	-	50	22.5	17	44	320	8070
WB80/50	80	-	-	50	22.5	17	44	240	8071
WB85/85/50	-	85	85	50	22.5	18.5	44	200	8072
WB100/100/70	-	100	100	70	30	23	54	100	8073
WB150/110/70	-	150	110	70	28	23	54	60	8076
WB150/150/70	-	150	150	70	35	29	54	56	8074
WB200/100/70	-	200	100	70	35	29	54	60	8075
WB200/155/80	-	200	155	80	35	29	54	40	8077
WB255/200/80	-	255	200	80	35	29	54	30	8078
WB300/250/120	-	300	250	120	35	29	54	10	8079
WB400/350/120	-	400	350	120	35	29	54	5	8080

INDUSTRIAL PLUGS AND SOCKETS

INDUOS PLUGS AND PLUGS A

EL[®]MARK

INDUSTRIAL PLUGS AND SOCKETS

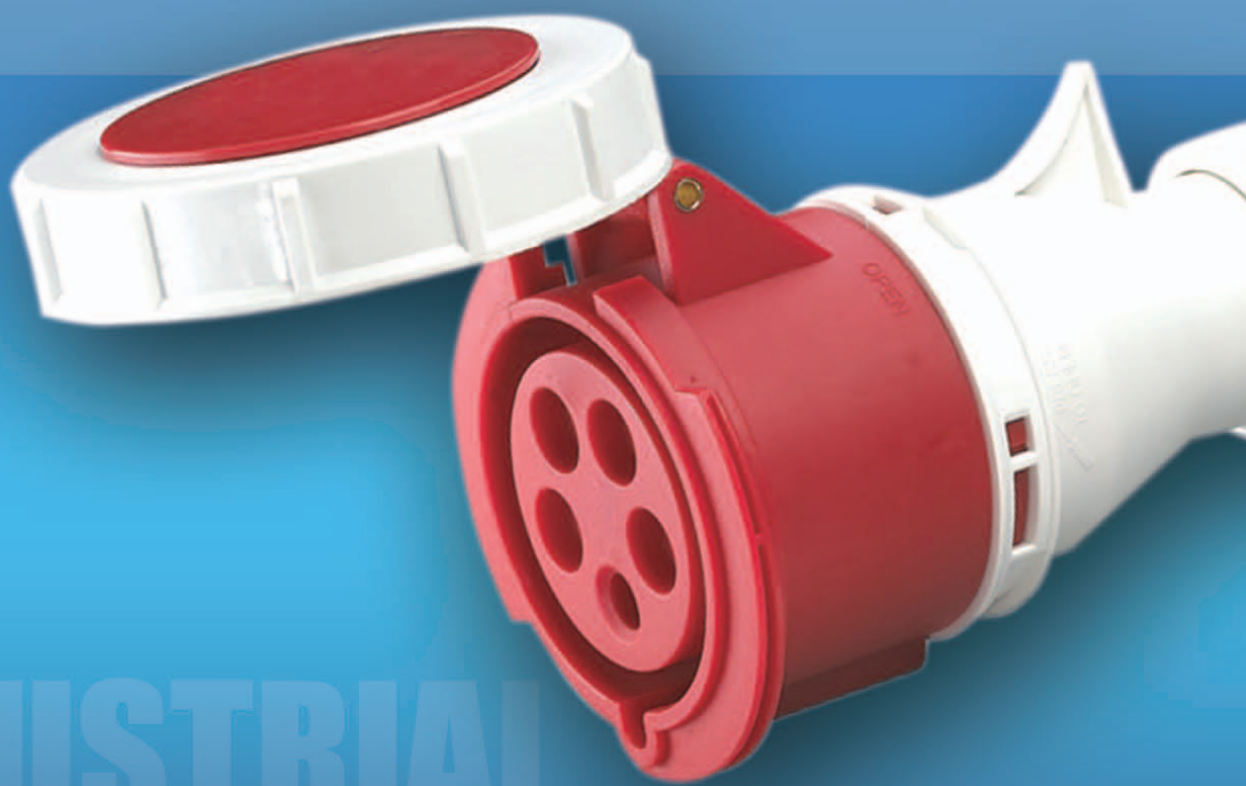

INDUSTRIAL PLUGS AND SOCKETS



Industrial plugs and sockets HT/HTN type

Made of special high quality plastic with alloys against aging at sun light exposing and for increasing the mechanical strength. They are designed in accordance with standard EN 60309 and provide reliable connection and high protection level against electrical current. They provide IP protection not less than IP 44/67. They are designed for surface or flush mounting, movable or fixed type.

Technical data:

- * Rated voltage: 500V
- * Rated short circuit current: according to the mounted protection in the boards
- * Impulse voltage wear resistance: 8kV
- * Mechanical wear resistance: 3000 cycles
- * IP rate: IP 44/67
- * Plastic: UV rays wear resistance
- * Ambient temperature: -5 to +55°C
- * Altitude: up to 2000m
- * Plugs and sockets: 6h

Documents corresponding to the product:
Standard EN 60309-1; EN 60309-2

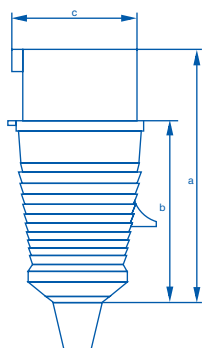

Model	In (A)	Poles	Un (V)	Dimensions (mm) a / b / c	Ingress protection rating IP	Packing/Box	Catalogue number
HT-013	16	1P+N+E	230	121 / 84 / 53	44	2 / 10 / 100	37013
HT-023	32	1P+N+E	230	138 / 92 / 63	44	2 / 10 / 60	37023



Model	In (A)	Poles	Un (V)	Dimensions (mm) a / b / c	Ingress protection rating IP	Packing/Box	Catalogue number
HT-014	16	3P+E	400	121 / 84 / 51	44	2 / 10 / 100	37014
HT-024	32	3P+E	400	138 / 92 / 63	44	2 / 10 / 60	37024
HT-034	63	3P+E	400	230 / 109 / 36	44	2 / 10	37034
HT-044	125	3P+E	400	295 / 124 / 50	44	2 / 10	37044



Model	In (A)	Poles	Un (V)	Dimensions (mm) a / b / c	Ingress protection rating IP	Packing/Box	Catalogue number
HT-015	16	3P+N+E	400	129 / 92 / 62	44	2 / 10 / 60	37015
HT-025	32	3P+N+E	400	149 / 97 / 70	44	2 / 10 / 60	37025
HT-035	63	3P+N+E	400	230 / 109 / 36	44	2 / 10	37035
HT-045	125	3P+N+E	400	295 / 124 / 50	44	2 / 10	37045



Model	In (A)	Poles	Un (V)	Dimensions (mm) a / b / c	Ingress protection rating IP	Packing/Box	Catalogue number
HTN 0131	16	1P+N+E	230	120/71/12	67	1 / 60	37131
HTN 0231	32	1P+N+E	230	150/93/17	67	1 / 40	37231



Model	In (A)	Poles	Un (V)	Dimensions (mm) a / b / c	Ingress protection rating IP	Packing/Box	Catalogue number
HTN 0141	16	3P+E	400	125/79/12	67	2 / 60	37141
HTN 0241	32	3P+E	400	150/93/17	67	2 / 40	37241
HTN 0341	63	3P+E	400	230/109/36	67	10	37341
HTN 0441	125	3P+E	400	230/109/36	67	10	37441



Model	In (A)	Poles	Un (V)	Dimensions (mm) a / b / c	Ingress protection rating IP	Packing/Box	Catalogue number
HTN 0151	16	3P+N+E	400	133/87/12	67	2 / 60	37151
HTN 0251	32	3P+N+E	400	155/99.5/17	67	2 / 40	37251
HTN 0351	63	3P+N+E	400	230/109/36	67	10	37351
HTN 0451	125	3P+N+E	400	295/124/50	67	10	37451

Fixed industrial plugs



Model	In (A)	Poles	Un (V)	Dimensions (mm) a / b	Ingress protection rating IP	Packing/Box	Catalogue number
HT-513	16	1P+N+E	230	121/79	44	2 / 10 / 60	37513
HT-523	32	1P+N+E	230	131/83	44	2 / 10 / 60	37523



Model	In (A)	Poles	Un (V)	Dimensions (mm) a / b	Ingress protection rating IP	Packing/Box	Catalogue number
HT 514	16	3P+E	400	121/76	44	2 / 10 / 60	37514
HT 524	32	3P+E	400	131/83	44	2 / 10 / 60	37524



Model	In (A)	Poles	Un (V)	Dimensions (mm) a / b	Ingress protection rating IP	Packing/Box	Catalogue number
HT 515	16	3P+N+E	400	123/79	44	2 / 10 / 60	37515
HT 525	32	3P+N+E	400	132/84	44	2 / 10 / 60	37525
HT 535	63	3P+N+E	400	132/84	44	2 / 10 / 60	37535

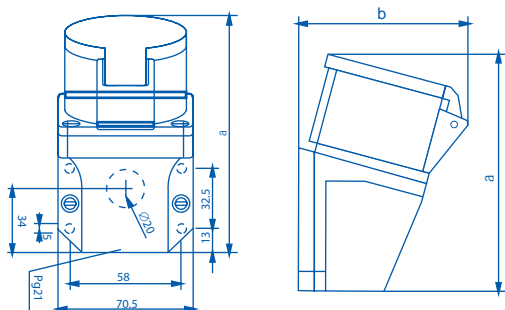

Model	In (A)	Poles	Un (V)	Dimensions (mm) a / b	Ingress protection rating IP	Packing/Box	Catalogue number
HT-113	16	1P+N+E	230	126 / 86	44	2 / 10 / 60	37113
HT-123	32	1P+N+E	230	141 / 97	44	2 / 10 / 60	37123

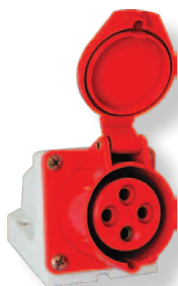

Model	In (A)	Poles	Un (V)	Dimensions (mm) a / b	Ingress protection rating IP	Packing/Box	Catalogue number
HT-114	16	3P+E	400	132 / 91	44	2 / 10 / 60	37114
HT-124	32	3P+E	400	141 / 96	44	2 / 10 / 60	37124
HT-134	63	3P+E	400	193 / 122	44	2 / 10	37134
HT-144	125	3P+E	400	220 / 140	44	2 / 10	37144



Model	In (A)	Poles	Un (V)	Dimensions (mm) a / b	Ingress protection rating IP	Packing/Box	Catalogue number
HT-115	16	3P+N+E	400	129 / 96	44	2 / 10 / 60	37115
HT-125	32	3P+N+E	400	141 / 98	44	2 / 10 / 60	37125
HT-135	63	3P+N+E	400	193 / 122	44	2 / 10	37135
HT-145	125	3P+N+E	400	220 / 140	44	2 / 10	37145



Model	In (A)	Poles	Un (V)	Dimensions (mm) a / b / c	Ingress protection rating IP	Packing/Box	Catalogue number
HTN 1131	16	1P+N+E	230	101/150/93.5	67	2 / 40	37731
HTN 1231	32	1P+N+E	230	114/162/93.5	67	2 / 40	37631



Model	In (A)	Poles	Un (V)	Dimensions (mm) a / b / c	Ingress protection rating IP	Packing/Box	Catalogue number
HTN 1141	16	3P+E	400	104/150/93.5	67	2 / 40	37741
HTN 1241	32	3P+E	400	116/162/93.5	67	2 / 40	37641
HTN 1341	63	3P+E	400	171/170/230	67	1 / 10	37842
HTN 1441	125	3P+E	400	171/170/230	67	1 / 6	37844



Model	In (A)	Poles	Un (V)	Dimensions (mm) a / b / c	Ingress protection rating IP	Packing/Box	Catalogue number
HTN 1151	16	3P+N+E	400	107/150/93.5	67	2 / 40	37751
HTN 1251	32	3P+N+E	400	116/162/93.5	67	2 / 40	37651
HTN 1351	63	3P+N+E	400	171/170/230	67	10	37852
HTN 1451	125	3P+N+E	400	171/170/230	67	6	37854

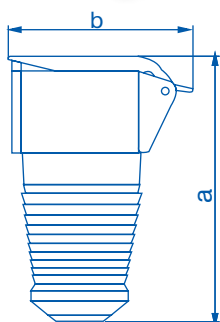

Movable industrial sockets for surface mounting



Model	In (A)	Poles	Un (V)	Dimensions (mm) a / b	Ingress protection rating IP	Packing/Box	Catalogue number
HT-213	16	1P+N+E	230	130 / 96	44	2 / 10 / 100	37213
HT-223	32	1P+N+E	230	149 / 90	44	2 / 10 / 60	37223





Model	In (A)	Poles	Un (V)	Dimensions (mm) a / b	Ingress protection rating IP	Packing/Box	Catalogue number
HT-214	16	3P+E	400	131 / 96	44	2 / 10 / 100	37214
HT-224	32	3P+E	400	149 / 90	44	2 / 10 / 60	37224
HT-234	63	3P+E	400	230/109	44	2 / 10	37234
HT-244	125	3P+E	400	290/124	44	2 / 10	37244



Model	In (A)	Poles	Un (V)	Dimensions (mm) a / b	Ingress protection rating IP	Packing/Box	Catalogue number
HT-215	16	3P+N+E	400	139 / 90	44	2 / 10 / 60	37215
HT-225	32	3P+N+E	400	154 / 100	44	2 / 10 / 60	37225
HT-235	63	3P+N+E	400	230/100	44	2 / 10	37235
HT-245	125	3P+N+E	400	290/124	44	2 / 10	37245



Model	In (A)	Poles	Un (V)	Dimensions (mm) a / b	Ingress protection rating IP	Packing/Box	Catalogue number
HTN 2131	16	 1P+N+E	230	131/90	67	2 / 60	37831
HTN 2231	32	 1P+N+E	230	149/90	67	2 / 40	37931



Model	In (A)	Poles	Un (V)	Dimensions (mm) a / b	Ingress protection rating IP	Packing/Box	Catalogue number
HTN 2141	16	3P+E	400	131/76	67	2 / 60	37841
HTN 2241	32	 3P+E	400	149/90	67	2 / 40	37941
HTN 2341	63	3P+E	400	271/115	67	10	37942
HTN 2441	125	3P+E	400	295/137	67	6	37943



Model	In (A)	Poles	Un (V)	Dimensions (mm) a / b	Ingress protection rating IP	Packing/Box	Catalogue number
HTN 2151	16	3P+N+E	400	139/90	67	2 / 60	37851
HTN 2251	32	 3P+N+E	400	154/100	67	2 / 40	37951
HTN 2351	63	3P+N+E	400	240/112	67	10	37952
HTN 2451	125	3P+N+E	400	300/126	67	6	37953

Industrial sockets for flush mouting



Model	In (A)	Poles	Un (V)	Dimensions (mm) a / b	Ingress protection rating IP	Packing/Box	Catalogue number
HT-413	16	1P+N+E	230	70/85	44	2 / 10 / 60	37413
HT-423	32	1P+N+E	230	80/97	44	2 / 10 / 60	37423



Model	In (A)	Poles	Un (V)	Dimensions (mm) a / b	Ingress protection rating IP	Packing/Box	Catalogue number
HT-414	16	3P+E	400	70/85	44	2 / 10 / 60	37414
HT-424	32	3P+E	400	80/97	44	2 / 10 / 60	37424



Model	In (A)	Poles	Un (V)	Dimensions (mm) a / b	Ingress protection rating IP	Packing/Box	Catalogue number
HT-415	16	3P+N+E	400	70/85	44	2 / 10 / 60	37415
HT-425	32	3P+N+E	400	80/97	44	2 / 10 / 60	37425

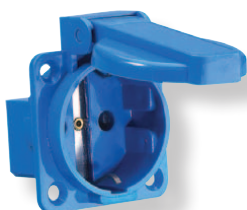

Model	In (A)	Poles	Un (V)	Dimensions (mm) a / b	Ingress protection rating IP	Packing/Box	Catalogue number
HT-105SR	16	German type	230	70/70	44	500	37105



Model	In (A)	Poles	Un (V)	Cable length (mm)	Ingress protection rating IP	Packing/Box	Catalogue number
213L-2P-W	16	1P+N+E	230	450	44	48	37003

DISTRIBUTION BOXES

DISTRIB BOXES

EL[®]MARK

DISTRIBUTION

S



DISTRIBUTION

BOXES



Distribution boxes with industrial plugs and sockets and protection device section

Documents corresponding to the product:

Standard EN 60309-1;
EN 60309-2; EN 60 529

They are specially designed distribution boxes with mounted industrial plugs and sockets fabric cabled with possibility for protection devices mounting (breakers, residual current devices). They are designed for building sites mounting, industrial projects for power supply of mobile – movable consumers, exhibition centers, outdoor concerts or repair- reconstruct operations with temporary character. The boxes are made of special high quality plastic with impurity against aging at sun light exposing and for increasing the mechanical strength. They are designed in accordance with standard EN 60529 and provide reliable connection and high protection rate of the staff from electrical current. They provide IP protection not less than IP 44.

Technical data:

- * Rated voltage: 400V
- * Rated short circuit current: according to the mounted safety fuses and residual current devices
- * Impulse voltage wear resistance: 8kV
- * Power supply cable: 5x2.5mm²
- * Mechanical wear resistance: 3000 cycles
- * IP rate: IP 44
- * Plastic: UV rays wear resistance
- * Ambient temperature: -5 to +55°C
- * Altitude: up to 2000m
- * Overall dimensions of the box: 136x94x425 mm



Type	Inlet power supply conductor (mm ²)	Outlets	Packing / Box	Catalogue number
EDB 100 - 401	3x2.5	3 sockets 16A 1P+N+E	1 / 8	53401
EDB 100 - 402	5x2.5	1 sockets 16A 3P+N+E and 2 sockets 16A 1P+N+E	1 / 8	53402
EDB 200 - 401	3x2.5	3 sockets 32A 1P+N+E	1 / 8	53421
EDB 100 - 501*	3x2.5	3 sockets 16A 1P+N+E	1 / 8	53501*

Note: * The distribution box is supplied with extension cable with section 3x2.5mm² and length 1.5m



Plastic distribution boxes for surface mounting

The distribution boxes are designed for mounting in newly built buildings or buildings in re-construction. They are a module box with mounted protective devices of the given flats electrical current circuit circles. They are supplied with transparent door for each row opening upwards to 90°. They are made of white self-extinguishing plastic, resistant to heat and high temperature with IP rate IP 40. The mounted device in the box is protected from direct contact to the current leading parts. They are offered with DIN-rail for device mounting and terminal strips for the neutral and earthing conductor joining. Mounted directly on the walls with screws.

Documents corresponding to the product:

Standard EN 62 208;
EN 60439-1;EN 60 439-3

Technical data:

- * Maximum insulation voltage: 690V; 50Hz
- * fire resistance rate: UL 94
- * IP rate: IP 40
- * Class of current limiting: 2

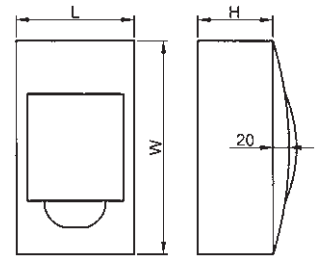

Number of rows	Module capacity (number of devices)	Terminal strips number	Openings number	Dimensions (mm)			Packing / Box	Catalogue number
				L	W	H		
1	4	2	9	110	205	75	1 / 20	60040
1	6	2	9	150	205	75	1 / 20	60060
1	8	2	14	190	205	75	1 / 20	60080
1	12	3	17	260	205	75	1 / 10	60120
1	18	4	25	365	220	75	1 / 10	60180
2	24	6	34	270	330	75	1 / 10	60240
3	36	8	43	310	475	85	1 / 5	60360



Plastic distribution boxes for flush mounting

The distribution boxes are designed for mounting in newly built buildings or buildings in reconstruction. They are a module box with mounted protective devices of the given flats electrical current circuit circles. They are supplied with transparent door for each row opening upwards to 90°. They are made of white self-extinguishing plastic, resistant to heat and high temperature with IP 40. The mounted device in the box is protected from indirect contact to the current leading parts. They are offered with DIN-rail for device mounting and terminal blocks for the neutral and grounded conductor joining. Mounted through building-in in openings on the wall under plaster or in plasterboard (through special brackets).

Documents corresponding to the product:

Standard EN 62 208;
EN 60439-1;EN 60 439-3

Technical data:

- * Maximum insulation voltage: 690V; 50Hz
- * fire resistance rate: UL 94
- * IP rate: IP 40
- * Class of current limiting: 2

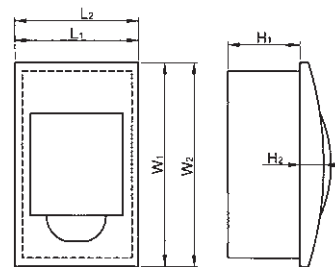

Number of rows	Module capacity (number of devices)	Terminal strips number	Openings number	Dimensions (mm)			Packing / Box	Catalogue number
				L	W	H		
1	4	2	9	110	205	75	1 / 20	60041
1	6	2	9	150	205	75	1 / 20	60061
1	8	2	14	190	205	75	1 / 20	60081
1	12	3	17	260	205	75	1 / 10	60121
1	18	4	25	365	220	75	1 / 10	60181
2	24	6	34	270	330	75	1 / 10	60241
3	36	8	43	310	475	85	1 / 5	60361



catalogue number 60085

Note: For plasterboard mounting should be used special brackets (4 pcs. set, catalogue number 60085, general packing - 10 sets).



Moisture-proof distribution boxes for surface mounting - IP 55

The distribution boxes are designed for mounting in newly built buildings or buildings in re-construction. They are a module box with mounted protective devices of the given flats electrical installation current circles. They are supplied with transparent door for each row opening upwards to 90°. They are made of white non-self-extinguishing plastic, resistant to heat and high temperature. The special design of the lids and gaskets provides IP rate IP 55. The mounted device in the box is protected from indirect contact to the current leading parts. They are offered with DIN-rail for device mounting and terminal strips for the neutral and earthing conductor joining. For direct wall mounting with screws.

Documents corresponding to the product:

Standard EN 62 209;
EN 60439-1;EN 60 439-3

Technical data:

- * Maximum insulation voltage: 690V; 50Hz
- * fire resistance rate: UL 94
- * IP rate: IP 55
- * Class of current limiting: 2

Type	Number of rows	Module capacity (number of devices)	Terminal strips number	Openings number	Dimensions (mm)			Packing / Box	Catalogue number
					L	W	H		
WP4	1	4	2	9	127	214	93	1 / 20	60100
WP6	1	6	2	9	162	214	93	1 / 20	60101
WP8	1	8	2	14	216	214	93	1 / 20	60102
WP12	1	12	3	17	270	214	93	1 / 12	60103
WP18	1	18	4	25	378	233	93	1 / 8	60104
WP24	2	24	6	34	340	288	93	1 / 8	60105



Stainless steel metal boxes

Supplied with a special lock, metal plate for fixing of electrical devices, lid for the input-output conductors, grounded dowel pin, gaskets, etc. Option to change the opening direction. Made of single stainless steel sheet. The mounting plate is treated with anti-corrosion and decorative powder coating. They are used in case of special requirements regarding the exposure of corrosion.

Documents corresponding to the product:

Standard EN 62 208;
EN 60439-1;EN 60 439-3

Technical data:

- * Rated voltage: up to 1000V
- * Maximum current: up to 800A
- * Material: stainless steel
- * IP rate: IP 55
- Mounting:
- * vertically on flat surface

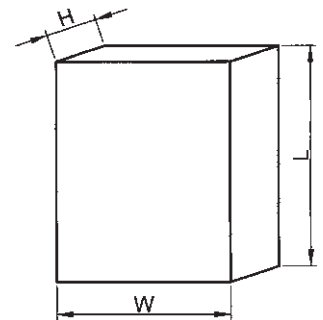

Type	Thickness of metal sheet (mm)	Metal box dimensions (mm)			Packing / Box	Catalogue number
		L (height)	W (width)	H (depth)		
SXF 25/25/15	1.0	250	250	150	1	54025
SXF 30/25/15	1.0	300	250	150	1	54030
SXF 40/30/20	1.0	400	300	200	1	54040
SXF 50/40/20	1.2	500	400	200	1	54050
SXF 60/40/20	1.2	600	400	200	1	54060
SXF 70/50/20	1.2	700	500	200	1	54070
SXF 80/60/25	1.5	800	600	250	1	54080
SXF 100/80/30	1.5	1000	800	300	1	54100
SXF 120/80/30	1.5	1200	800	300	1	54120



Metal distribution boxes

Supplied with a special lock, metal plate for fixing of electrical devices, lid for the input-output conductors, grounded dowel pin, gaskets, etc. Option to change the opening direction. Made of single steel sheet, treated with decorative powder coating.

Technical data:

- * Rated voltage: up to 1000V
- * Maximum current: up to 1250A
- * Material: steel
- * RAL 7032
- * Coating: powder style painting
- * IP rate: IP 55
- Mounting:
- * vertically on flat surface

Documents corresponding to the product:
Standard EN 62208;
EN 60439-1;EN 60 439-3

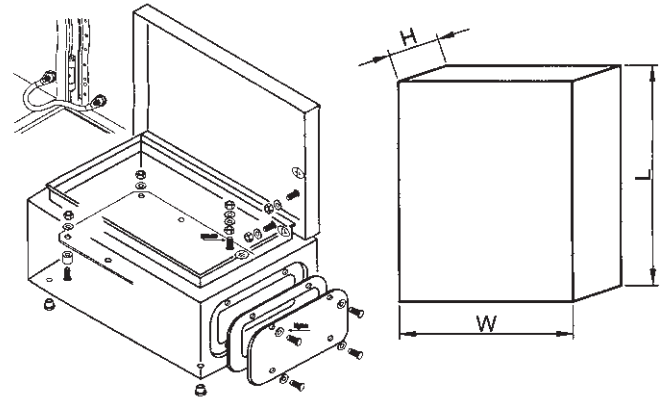
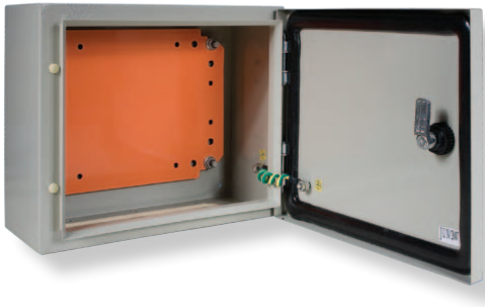

Type	Thickness of metal sheet (mm)	Metal box dimensions (mm)			Nominal working current In (A)	Packing / Box	Catalogue number
		L (height)	W (width)	H (depth)			
JXF 25/25/15	1.0	250	250	150	80	1	53025
JXF 25/30/15	1.0	250	300	150	100	1	53026
JXF 30/25/15	1.0	300	250	150	100	1	53030
JXF 30/40/20	1.0	300	400	200	160	1	53031
JXF 40/30/20	1.0	400	300	200	160	1	53040
JXF 40/50/20	1.2	400	500	200	250	1	53041
JXF 40/40/20	1.2	400	400	200	250	1	53044
JXF 50/40/20	1.2	500	400	200	250	1	53050
JXF 40/60/20	1.2	400	600	200	250	1	53051
JXF 60/40/20	1.2	600	400	200	250	1	53060
JXF 60/60/20	1.2	600	600	200	250	1	53066
JXF 70/50/20	1.2	700	500	200	350	1	53070
JXF 80/60/25	1.5	800	600	250	400	1	53080
JXF 100/80/30	1.5	1000	800	300	630	1	53100
JXF 120/80/30	1.5	1200	800	300	630	1	53120
JXF 140/80/30	1.5	1400	800	300	800	1	53140
JXF 180/80/30	1.5	1800	800	300	1000	1	53188
JXF 180/100/30*	1.5	1800	1000	300	1250	1	53180

Note: *Metal boxes with double door

Electric Switchboards with Type-Approval Certificates

The company has produced and successfully passed the type-approval procedures for the following metal and plastic electric control boxes and boards with ELMARK automation:

- Tower Mounted Switchgear
- Low Voltage Meter Box
- Low Voltage Main Switchboard
- Distribution Switchboard
- Power Compensation System

Documents corresponding to the product:
Standard EN 60439-1;
EN 60 439-3

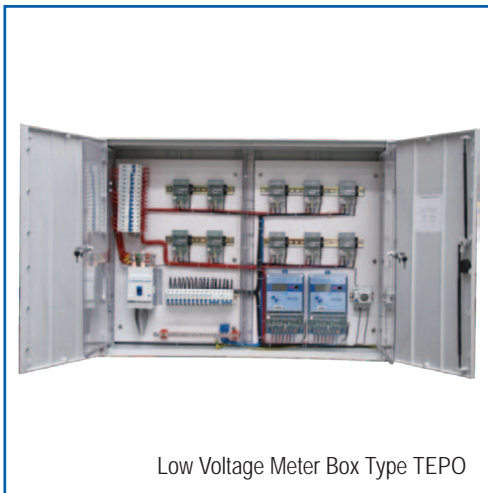

Low Voltage Meter Box Type TEPO

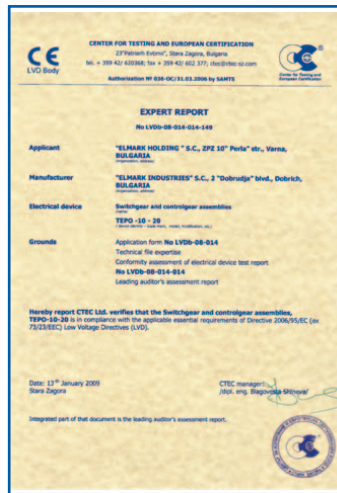

Low Voltage Main Switchboard Type GRT

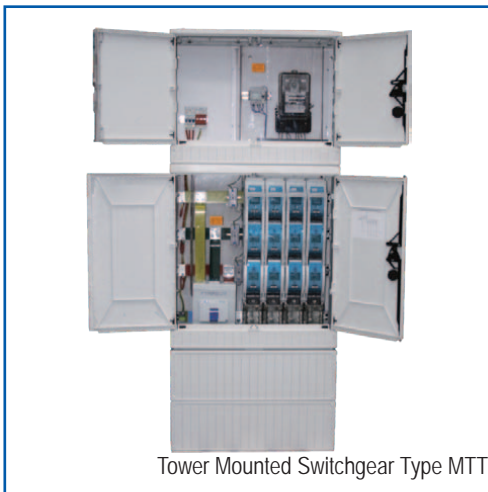

Tower Mounted Switchgear Type MTT



Power Compensation System Type CCU



Distribution Switchboard Type KRSH

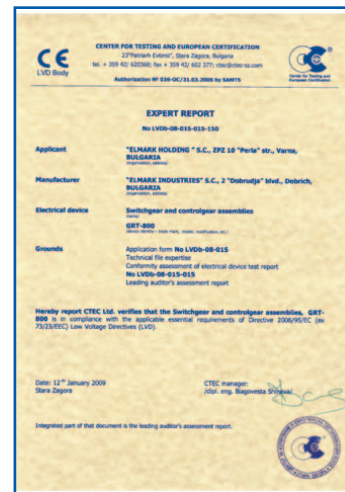
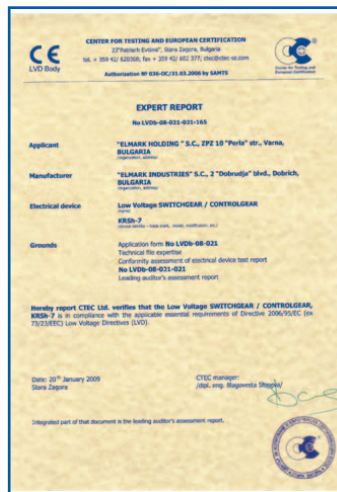



Plastic distribution boards

Plastic distribution boards of various sizes. Intended for extension or distribution of cable lines. They can also be used as meter boxes. Boards are made of polyester or ABS. They are resistant to chemical agents, thermal and UV rays.

Documents corresponding to the product:
Standard EN 60439 -1
EN 60439 -5

Technical Specifications:

- Resistance: chemical agents, weak acids, alkali, oils, salts, etc.
- Rated Voltage: up to 690V
- Maximum Current: up to 800A
- Thermal Deformation: over 240°C
- Operating Temperature: -35°C + 40°C
- Material: ABS
- IP rate: IP65
- Colour: RAL7035 grey
- Recyclable
- adjustable mounting plate position

Mounting:

- Vertically on flat surface



Board Type	Material Type	L (mm)	W (mm)	H (mm)	Packing / Box	Catalogue number
CP 5001	ABS	210	280	130	1	5312128130
CP 5002	ABS	250	330	130	1	5312533130
CP 5003	ABS	300	400	165	1	5313040165
CP 5003D	ABS	300	400	195	1	5313040195
CP 5007	ABS	350	500	195	1	5313550195
CP 5004	ABS	400	500	175	1	5314050175
CP 5005	ABS	400	600	200	1	5314060200

Note: Open door angle 180°



Board Type	Material Type	L (mm)	W (mm)	H (mm)	Packing / Box	Catalogue number
CP 5111-8modules	ABS	210	280	130	1	5322128130
CP 5112-18modules	ABS	250	330	130	1	5322533130
CP 5113-24modules	ABS	300	400	165	1	5323040165
CP 5114-54modules	ABS	400	500	175	1	5324050175
CP 5115-60modules	ABS	400	600	200	1	5324060200

Note: Transperent door



Board Type	Material Type	L (mm)	W (mm)	H (mm)	Packing / Box	Catalogue number
CP 501	polyester	300	200	150	1	5333020150
CP 503	polyester	250	300	155	1	5332530155
CP 504	polyester	300	400	180	1	5333040180
CP 505	polyester	400	500	190	1	5334050190
CP 506	polyester	400	600	200	1	5334060200
CP 508	polyester	500	800	285	1	5335080285

Note: Open door angle 90°

CABLETTE

CABLE TERMINALS

EL[®]MARK



Connection tubes - GTY type

Copper pipes with galvanic tin coating, used for joining of copper rigid or multicore conductors with different sections. The assembling is made by mechanical pressing with crimping tool.

- Technical data:
 * Material: copper alloy
 * Coating: tin
 * Application: general

Standard: EN 61 238-1

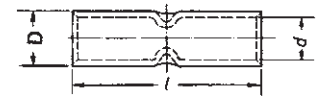

Type	Length L (mm)	Outer diameter D (mm)	Inner diameter d (mm)	Cable (mm ²)	Packing / Box (pcs)	Catalogue number
GTY-4	20	5	3	4	1000 / 16000	59213
GTY-6	25	5.3	3.7	6	500 / 1500 / 12000	59201
GTY-10	30	6.3	4.5	10	500 / 1500 / 12000	59202
GTY-16	35	7.5	5.7	16	100 / 200 / 4800	59203
GTY-25	40	9	7.2	25	100 / 500 / 2000	59204
GTY-35	45	10.8	8.5	35	100 / 200 / 1600	59205
GTY-50	50	12.5	9.8	50	20 / 200 / 1600	59206
GTY-70	55	14.5	11.5	70	10 / 100 / 800	59207
GTY-95	60	17	13.7	95	10 / 80 / 640	59208
GTY-120	65	19	15	120	10 / 60 / 480	59209
GTY-150	70	21	16.7	150	10 / 50 / 400	59210
GTY-185	75	23	18.5	185	10 / 40 / 320	59211
GTY-240	80	26	21	240	10 / 30 / 240	59212



Bimetalllic connection tube - GTL type

Pipes made of two metals – copper and aluminum without galvanic coating. They are designed for joining copper and aluminum conductors – rigid or multicore conductors with different section. The connection is accomplished through crimping pliers, through mechanical pressing of the butt terminals and the conductor. They are used for protection against electrochemical corrosion got at two metals contact with different chemical properties and conductivity at electrical current feed. They are manufactured under modern technology and have high quality and long exploitation period.

Standard: EN 61 238-1

Technical data:

* Material: copper aluminum alloy

* Coating: none

* Application: general for joining of two types of conductors

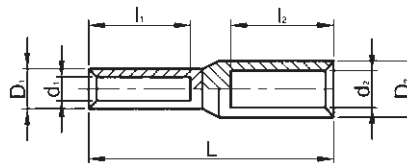

Butt terminal type	d1	D1	d2	D2	l1	l2	L	Packing / Box (pcs)	Catalogue number
GTL - 16	5	9	6	10	30	30	75	20 / 200 / 1200	59214
GTL - 25	6	10	7	12	30	33	82	20 / 400 / 1500	59215
GTL - 35	7	11	8.5	14	30	40	90	20 / 300 / 1000	59216
GTL - 50	8.5	13	9.8	16	32	42	95	20 / 800	59217
GTL - 70	9.5	15	11.5	18	38	50	105	10 / 600	59218
GTL - 95	11.5	17	13.5	21	40	50	110	10 / 500	59219
GTL - 120	13.5	19	15	23	42	55	112	10 / 400	59220
GTL - 150	15	21	17	25	44	55	118	10 / 350	59221
GTL - 185	17	23	18.5	27	46	60	125	10 / 300	59222
GTL - 240	19	26	21	30	54	60	130	10 / 200	59223



Cable terminals without insulation - JM type

They are used for joining copper conductors - multicore conductors with different section to electrical devices or connections to combine all cores of the conductor, to provide safe connection at tightening in terminals and safe connection at the base of the terminal. Thus the connection stability against vibrations is increased and the possibility for short circuit is decreased. They are made of copper alloy with galvanic tin coating. The connection is realized through crimping pliers, through mechanic pressing of the terminal and conductor. Two types are offered with standard length SC and extended base JM. They are manufactured under modern technology and have high quality and long exploitation period.

Standard: EN 61 238-1

Technical data:

- * Material: copper alloy
- * Coating: tin
- * Application: general for joining conductors to electrical devices.

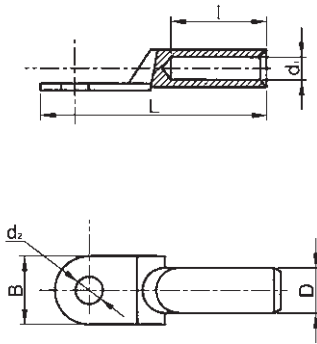

Shoe type	d1 (mm)	D (mm)	d2 (mm)	L (mm)	Packing / Box (pcs)	Catalogue number
JM - 2.5/6	2.2	4.5	6	24	1000 / 3000 / 24000	59240
JM - 4/6	3.0	4.8	6	24	1000 / 2000 / 16000	59241
JM - 6/6	3.8	5.5	6	24	500 / 2000 / 16000	59035
JM - 6/8	3.8	5.5	8	24	500 / 2000 / 16000	59059
JM - 10/6	4.8	6.8	6	25.5	500 / 1500 / 12000	59036
JM - 10/8	4.8	6.8	8	25.5	500 / 1500 / 12000	59037
JM - 16/6	5.5	7.5	6	30.5	400 / 800 / 6400	59038
JM - 16/8	5.5	7.5	8	30.5	400 / 800 / 6400	59039
JM - 16/10	5.5	7.5	10	30.5	400 / 800 / 6400	59040
JM - 25/8	7	9	8	34	250 / 500 / 4000	59041
JM - 25/10	7	9	10	34	250 / 500 / 4000	59042
JM - 35/8	8.2	10.5	8	38	200 / 400 / 3200	59043
JM - 35/10	8.2	10.5	10	38	200 / 400 / 3200	59044
JM - 35/12	8.2	10.5	12	38	200 / 400 / 3200	59045
JM - 50/8	9.8	12.5	8	45	100 / 200 / 1600	59046
JM - 50/10	9.8	12.5	10	45	100 / 100 / 1600	59047
JM - 50/12	9.8	12.5	12	45	100 / 200 / 1600	59048
JM - 70/10	11.5	14.5	10	50	80 / 100 / 1280	59049
JM - 70/12	11.5	14.5	12	50	80 / 100 / 1280	59050
JM - 95/10	13.8	17.5	10	55.5	50 / 200 / 800	59051
JM - 95/12	13.8	17.5	12	55.5	50 / 200 / 800	59052
JM - 120/10	15.5	19.5	10	63	30 / 60 / 480	59053
JM - 120/12	15.5	19.5	12	63	30 / 60 / 480	59054
JM - 150/12	16.5	21	12	71	10 / 50 / 400	59055
JM - 185/12	18.8	23.5	12	78	10 / 40 / 320	59056
JM - 185/16	18.8	23.5	16	78	10 / 40 / 320	59057
JM - 240/16	21.3	26.5	16	92	10 / 30 / 240	59058



Bimetallic non-insulated cable terminals for crimping DTL

Standard: EN 61 238-1

They are used for joining aluminum conductors - multicore conductors with different section to electrical devices or connections to combine all cores of the conductor, to provide safe connection at tightening in terminals and safe connection at the base of the terminal. Thus the connection stability against vibrations is increased and the possibility for short circuit is decreased. They are made of copper and aluminum alloys as in the aluminum billet is made under special technology the copper terminal formed like an ear. The connection is realized through crimping pliers, through mechanic pressing of the terminal and conductor. They are manufactured under modern technology and have high quality and long exploitation period.

Technical data:

* Material: copper aluminum

* Application: general for joining conductors to electrical devices.

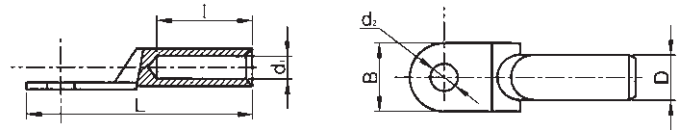

Shoe type	d1 (mm)	D (mm)	d2 (mm)	L (mm)	l (mm)	B (mm)	Packing / Box (pcs)	Catalogue number
DTL - 1 - 16	6	11	8	70	30	16	20 / 200 / 1440	59224
DTL - 1 - 25	7	12	8	75	34	18	20 / 180 / 1080	59225
DTL - 1 - 35	8.5	14	10	85	38	20.5	20 / 100 / 600	59226
DTL - 1 - 50	9.8	16	10	90	40	23	20 / 70 / 420	59227
DTL - 1 - 70	11.5	18	12	102	48	26	10 / 60 / 360	59228
DTL - 1 - 95	13.5	21	12	112	50	28	10 / 40 / 180	59229
DTL - 1 - 120	15	23	14	120	53	30	10 / 30 / 120	59230
DTL - 1 - 150	16.5	25	14	126	56	34	5 / 25 / 120	59231
DTL - 1 - 185	18.5	27	16	133	58	37	5 / 20 / 120	59232
DTL - 1 - 240	21	30	16	140	60	40	4 / 12 / 72	59233

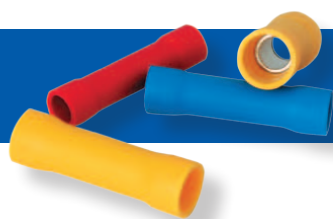

Insulated cable joints

Metal pipes with outside PVC insulation. They are used for joining/extending multicore conductors with section up to 6mm². It increases the connection stability against vibrations and decreases the possibility for short circuit. The connection is realized through crimping pliers, through mechanic pressing of the terminal and conductor. The different insulation colour corresponds to different conductor sections.

Standard: EN 61 238-1

Technical data:

* Material: copper alloy

* Coating: polyvinylchloride

* Application: general for joining of copper conductors

Type	Length (mm)	Colour	Conductor (mm ²)	Packing (pcs.)	Packing / Box (pcs.)	Catalogue number
PVT 1.25	16	red	1	100	10 / 120	59015
BV 1.25	25	red	1	100	10 / 120	59001
PVT 2	16	blue	1.5-2.5	100	10 / 120	59034
BV 2	25	blue	1.5-2.5	100	10 / 60	59002
PVT 5.5	20	yellow	4-6	100	5 / 60	59014
BV 5.5	25	yellow	4-6	100	5 / 60	59003

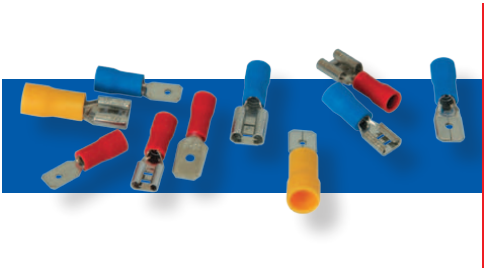

Insulated cable terminals - MDD/FDD types

They represent a cable terminal made of brass alloy with galvanic tin coating and insulated with polyvinylchloride. They are used as non-insulated terminals, as the insulated part protects the cores from bending and breaking in the joining point and at the same time it protects the staff from direct contact to the current - carrying parts. They are used for conductors with section up to 6 mm. The connection is realized through crimping pliers, through mechanic pressing of the terminal and cable. The different insulation colour corresponds to different conductor sections. They are manufactured under modern technology and have high quality and long exploitation period.

All insulated cable terminals are being offered in 100 pcs. packing

Technical data:

- * Material: copper alloy
- * Coating: polyvinylchloride
- * Application: general for joining copper conductors
- * Ambient temperature: -10 to +75°C

Type	Shape	Colour	Conductor (mm ²)	Shoe width	Packing (pcs.)	Packing / Box (pcs.)	Catalogue number
MDD 1.25 - 187	male	red	1	187	100	10 / 240	59012
MDD 1.25 - 250	male	red	1	250	100	10 / 240	59009
MDD 2 - 187	male	blue	1.5-2.5	187	100	10 / 240	59013
MDD 2 - 250	male	blue	1.5-2.5	250	100	10 / 180	59011
MDD 5.5 - 250	male	yellow	4-6	250	100	10 / 120	59010
FDD 1.25 - 187	female	red	1	187	100	20 / 240	59008
FDD 1.25 - 187	female	red	1	250	100	15 / 180	59006
FDD 2 - 187	female	blue	1.5-2.5	187	100	20 / 240	59007
FDD 2 - 250	female	blue	1.5-2.5	250	100	10 / 180	59004
FDD 5.5 - 250	female	yellow	4-6	250	100	10 / 120	59005

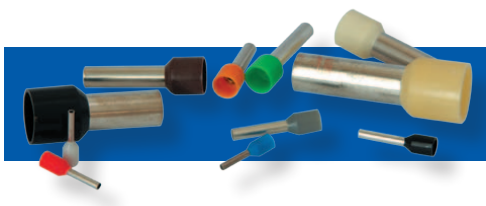

Insulated cable terminals - E type

Type	Colour	Terminal length (mm)	Conductor (mm ²)	Packing (pcs.)	Packing / Box (pcs.)	Catalogue number
E0508	white	8	0.5	100	50 / 600	59023
E7508	blue	8	0.75	100	50 / 600	59024
E1008	red	8	1.0	100	50 / 600	59025
E1510	black	10	1.5	100	30 / 360	59026
E2512	grey	12	2.5	100	30 / 300	59027
E4012	orange	12	4.0	100	20 / 240	59028
E6018	green	18	6.0	100	5 / 120	59029
E10-18	dark green	18	10	100	8 / 96	59030
E16-18	milky yellow	18	16	100	6 / 60	59031
E25-16	black	16	25	100	5 / 36	59032
E35-25	grey-yellow	25	35	100	2 / 24	59033



Insulated cable terminals - RVL type

Type	Size of the opening (mm)	Colour	Conductor (mm ²)	Packing (pcs.)	Packing / Box (pcs.)	Catalogue number
RVL 1.25-4	4	red	1	100	20 / 240	59021
RVL 1.25-5	5	red	1	100	15 / 180	59022
RVL 2-4	4	blue	1.5-2.5	100	15 / 180	59018
RVL 2-5	5	blue	1.5-2.5	100	10 / 120	59019
RVL 5.5-4	4	yellow	4-6	100	8 / 96	59020
RV 5.5-5	5	yellow	4-6	100	8 / 96	59016
RV 5.5-6	6	yellow	4-6	100	8 / 96	59017

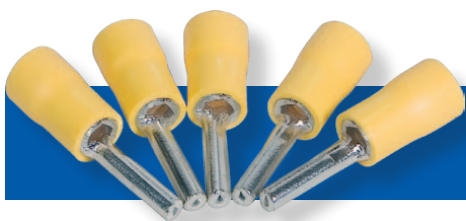

Insulated cable terminals - PTV type

Type	Shape	Colour	Conductor (mm ²)	Shoe width	Packing (pcs.)	Packing / Box (pcs.)	Catalogue number
PTV 1.25 - 10	male	red	0.25-1.5	1.9	100	20 / 240	59101
PTV 1.25 - 12	male	red	0.25-1.5	1.9	100	20 / 240	59102
PTV 2 - 10	male	blue	1.5-2.5	1.9	100	20 / 240	59103
PTV 2 - 12	male	blue	1.5-2.5	1.9	100	15 / 180	59104
PTV 5.5 - 13	male	yellow	4-6	2.9	100	8 / 96	59105

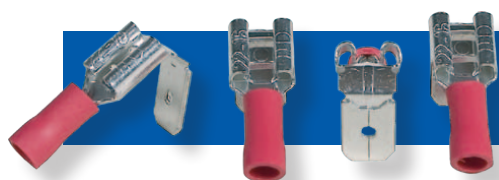

Insulated cable terminals - PBDD type

Type	Shape	Colour	Conductor (mm ²)	Shoe width	Packing (pcs.)	Packing / Box (pcs.)	Catalogue number
PBDD 1.25 - 250	male	red	0.25-1.5	6.3	100	5 / 60	59106
PBDD 2 - 250	male	blue	1.5-2.5	6.3	100	5 / 60	59107
PBDD 5.5 - 250	male	yellow	4-6	6.3	100	5 / 60	59108



Insulated cable terminals - MPD type

Type	Shape	Colour	Conductor (mm ²)	Shoe width	Packing (pcs.)	Packing / Box (pcs.)	Catalogue number
MPD 1.25 - 156	male	red	0.25-1.5	6.3	100	10 / 240	59109
MPD 2 - 195	male	blue	1.5-2.5	6.3	100	10 / 120	59110
MPD 5.5 - 195	male	yellow	4-6	6.3	100	10 / 120	59111



Insulated cable terminals - MDFN type

Type	Shape	Colour	Conductor (mm ²)	Shoe width	Packing (pcs.)	Packing / Box (pcs.)	Catalogue number
MDFN 1.25 - 250	male	red	0.25-1.5	4	100	5 / 60	59112
MDFN 2 - 250	male	blue	1.5-2.5	4	100	5 / 60	59113
MDFN 5 - 250	male	yellow	4-6	5	100	4 / 48	59114



Insulated cable terminals - CHS type

Type	Length (mm)	Conductor (mm ²)	Packing (pcs.)	Packing / Box (pcs.)	Catalogue number
CHS3	18.1	0.25-1.5	100	250	59115
CHS4	20.1	1.5-2.5	100	200	59116
CHS5	25.5	4-6	100	200	59117
CHS6	27.3	8	100	100	59118

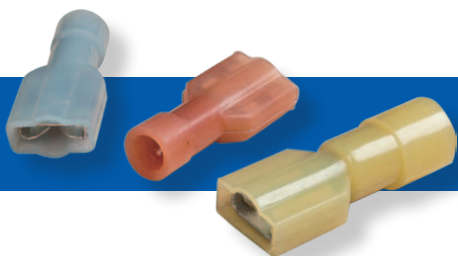

Insulated cable terminals - FDFNY type

Type	Length (mm)	Conductor (mm ²)	Colour	Packing / Box (pcs.)	Packing / Box (pcs.)	Catalogue number
FDFNY	250	1,25	red	100	10 / 60	59242
FDFNY	250	2	blue	100	10 / 60	59243
FDFNY	250	5,5	yellow	100	10 / 60	59244

ACCESSORIES

ACCESSORIES



EL[®]MARK

SORIES



ACCESSORIES

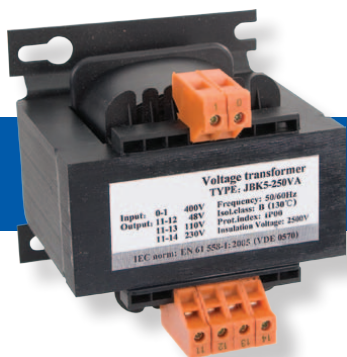

EVT5 - control voltage transformer

Documents corresponding to the product:
Standard EN 60051-1

Functions:

- Reduction of main voltage within standard range
- * Galvanic separation of the power supply circuit from the operation circuit

Technical features:

- * Input voltage: 400 or 230 V
- * Output voltage: See the table on the next page
- * Frequency : 50/60Hz
- * Short circuit resistance: unstable
- * Temperature class: B (130°C)
- * Construction: open (for installation in other products)
- * Magnetic circuit: cold rolled electric furnace steel
- * Coils: pure electrotechnical copper
- * Protection degree: IP20

Connection:

- * flexible or hard conductors of relevant section to terminals

Mounting:

- * Mounting in distribution boards or products
- * fastening: by means of screws/bolts to the surface
- * position: vertical
- * ambient temperature: -20 ÷ +40°C

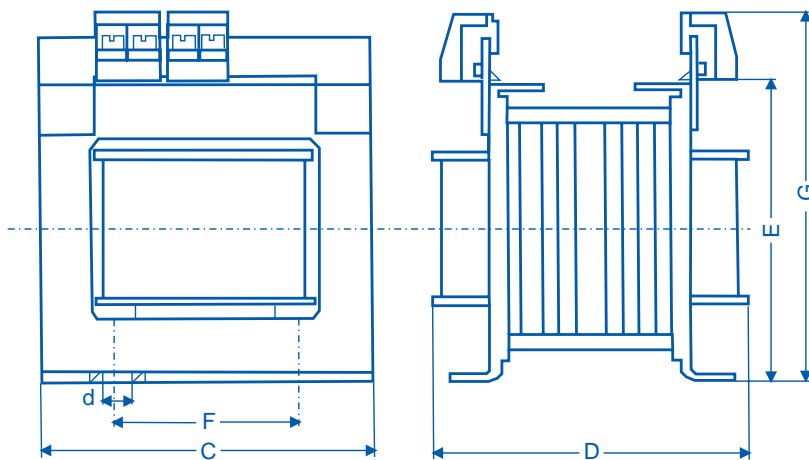

Type	Initial voltage (V)	Secondary voltage (V)	Power VA	Dimensions						Packing / Box (pcs.)	Catalogue number
				C	D	E	F	G	d		
EVT5 - 100VA	230	48-36	100	84	90	63	65	95	4	16	45248
EVT5 - 100VA	400	48-36	100	84	90	63	65	95	4	16	45448
EVT5 - 100VA	230	24-12	100	84	90	63	65	95	4	16	45243
EVT5 - 100VA	400	24-12	100	84	90	63	65	95	4	16	45443
EVT5 - 250VA	230	48-24-12	250	130	100	120	53	130	20	16	45242
EVT5 - 250VA	230	48-36	250	130	100	120	53	130	20	16	45242N
EVT5 - 250VA	400	48-24-12	250	130	100	120	53	130	20	12	45442
EVT5 - 250VA	400	48-36	250	130	100	120	53	130	20	12	45442N
EVT5 - 250VA	230	24-12	250	130	100	120	53	130	20	12	45244
EVT5 - 250VA	400	24-12	250	130	100	120	53	130	20	12	45444
EVT5 - 500VA	230	48-24-12	500	150	113	133	53	140	20	4	45245
EVT5 - 500VA	230	48-36	500	150	113	133	53	140	20	4	45245N
EVT5 - 500VA	400	48-24-12	500	150	113	133	53	140	20	4	45445
EVT5 - 500VA	400	48-36	500	150	113	133	53	140	20	4	45445N
EVT5 - 500VA	230	24-12	500	150	125	133	53	140	20	4	45246
EVT5 - 500VA	400	24-12	500	150	125	133	53	140	20	4	45446
EVT5 - 500VA	230	110-48-24	500	150	125	133	53	140	20	4	45215
EVT5 - 500VA	400	110-48-24	500	150	125	133	53	140	20	6	45415
EVT5 - 1000VA	230	48-24-12	1000	170	125	150	65	155	20	2	45241
EVT5 - 1000VA	230	48-36	1000	170	125	150	65	155	20	2	45241N
EVT5 - 1000VA	400	48-24-12	1000	170	125	150	65	155	20	2	45441
EVT5 - 1000VA	400	48-36	1000	170	125	150	65	155	20	2	45441N
EVT5 - 1000VA	230	24-12	1000	170	125	150	65	155	20	2	45247
EVT5 - 1000VA	400	24-12	1000	170	125	150	65	155	20	2	45447
EVT5 - 1600VA	230	48-24-12	1600	190	125	150	65	170	20	2	452416
EVT5 - 1600VA	230	48-36	1600	190	125	150	65	170	20	2	452416N
EVT5 - 1600VA	400	48-24-12	1600	190	125	150	65	170	20	2	454416
EVT5 - 1600VA	400	48-36	1600	190	125	150	65	170	20	2	454416N
EVT5 - 1600VA	230	24-12	1600	190	125	150	65	170	20	2	452417
EVT5 - 1600VA	400	24-12	1600	190	125	150	65	170	20	2	454417



German type socket for DIN rail mounting

German type socket for DIN rail mounting
It provides plug presence in electric boards and easy cabling.
* Supply voltage: 230V
* Computing option: up to 16A
* Operation temperature: from -10 up to +40°C
* Humidity: up to 85%RH
Mounting method:
* DIN rail

Type	Packing / Box (pcs)	Catalogue number
German type socket for DIN rail	5 / 100	37004

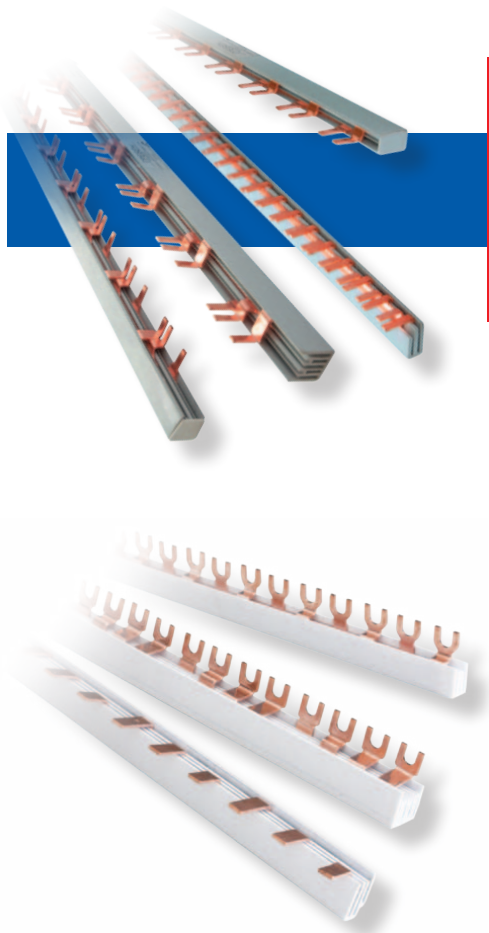

Supply busbar

Functions:

- * enables the supply of a group of conductors
- * provides simultaneous supply
- * conducting section – electrotechnical copper
- * insulation of the conducting section

Technical data:

- * Rated operating voltage: 230/400V
- * Isolating voltage: 500V
- * Abnormal heating wear resistance and fire of the outer parts: 960°C/3sec.
- * Rated current (phase): 63/100A

Connecting:

- * to the joining terminal of the breaker

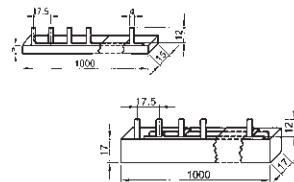

Type (copper busbar)	Length (m)	Poles (number)	In with one point of power supply	In with two points of power supply	Packing / Box (pcs)	Catalogue number
1P 63	1	54	63A	90A	20 / 100	14163
1P 100	1	54	100A	120A	20 / 100	14190
2P 63	1	28	63A	90A	10 / 50	14263
3P 63	1	18	63A	90A	6 / 30	14363
3P 100	1	18	100A	120A	5 / 50	14390
DP 1N	1	56	63A	90A	10 / 50	14463
C100 1P	1	-	125A	150A	20 / 100	14190T
C100 2P	1	-	125A	150A	10 / 50	14290T
C100 3P	1	-	125A	159A	5 / 20	14390T
U 1P 63	1	54	63A	90A	20 / 100	14163U
U 2P 63	1	28	63A	90A	10 / 50	14263U
U 3P 63	1	18	63A	90A	6 / 30	14363U
U 4P 63	1	13	63A	90A	5 / 20	14463U

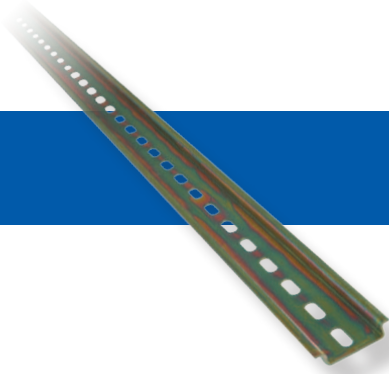

Mounting (DIN) rail

Functions:

- * serves for mounting breakers, residual current devices, contactors and other elements
- * provides a firm fixation of the elements

Technical data:

- * brass alloy with galvanic cover
- * factory drilled mounting openings
- * length up to 1m

Connecting:

- with bolts or other fixing elements to the mounting surface

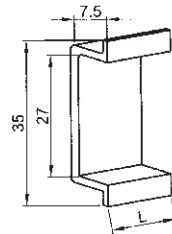

Length (m)	Packing / Box (pcs)	Catalogue number
1m	20 / 100	14001

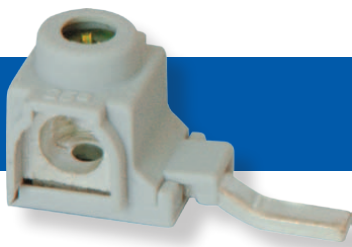

Insulating mounting terminal - TB25

Functions:

- * provides a firm joining of rigid or flexible conductors up to 35mm² to power supply busbar
- * provides a firm joining of the power supply conductor to the breaker
- * provides enough contact surface of the conductor

Technical data:

- * Brass alloy with galvanic cover
- * Fabric isolated with plastic cover
- * Appropriate for joining to copper or aluminum cables
- * Rated voltage: 230V
- * Rated current: up to 63A
- * Isolating voltage: ≥500V
- * IP rate: IP>20
- * Section of power supply conductor: up to 35mm²

Connecting:

- * to the joining terminal of the breaker

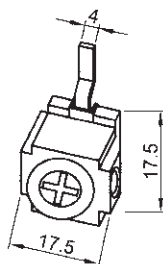

Type	Section of the conductor (mm ²)	Rated current I _n (A)	Packing / Box (pcs)	Catalogue number
TB 25	2.5 to 35	63	20 / 2000	31025

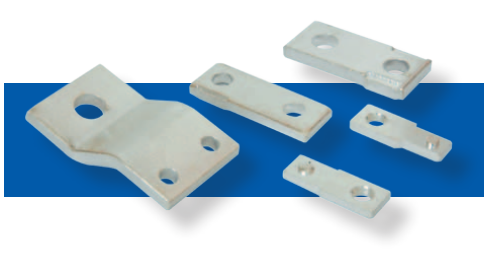

Terminal plates for MCCB - DS1 type

Straight copper electro-tinned extensions enabling cable connection outside the switch terminals and providing excellent contact with the switch terminal base. Terminal extensions with different cross section are available depending on the switch rated power.

Mounting:

Extensions are directly bolt mounted to the switch terminal base.

Type	Rated current (A)	Packing (pcs.)	Catalogue number
TP 125	125	6	31125
TP 160	160	6	31160
TP 250	250	6	31250
TP 400	400	6	31400
TP 630	630	6	31630
TP 800	800	6	31850
TP 1250	1250	6	311250

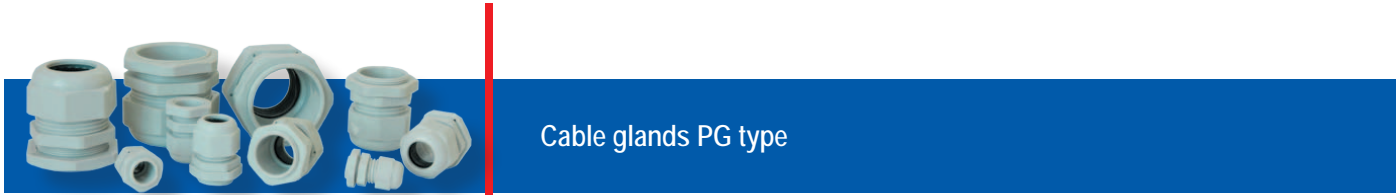

Cable glands PG type

Standard: EN 60 423; 48580-81

Plastic pipes supplied with the corresponding gaskets and nuts. Designed to provide necessary IP rate on the points where conductors pass through the walls of the electric distribution boxes. All cable gland elements are made of high quality plastic (PE) and rubber.

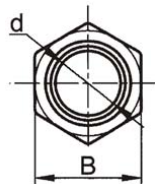
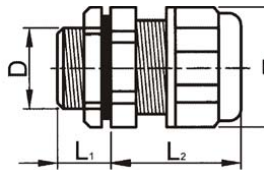

Technical data:

- * Material: polyethylene (PE)
- * Colour: gray
- * Application: general
- * Ambient temperature: -40 to +85°C
- * IP rate: IP 55

Type	Overlapping field	T (mm)	B (mm)	d (mm)	D (mm)	L1 (mm)	L2 (mm)	Packing / Box (pcs)	Catalogue number
PG-7	3.5-6.8	16.3	18	12	6.6	10	22	100 / 4000	500070
PG-9	5-8	18.9	21.7	15.5	8.5	10	25	100 / 4000	500090
PG-11	6-10	21.7	23.5	18.5	10.4	8.5	29	100 / 3000	500110
PG-13.5	7-12	23.6	26.5	20	13	10	29	100 / 2000	500135
PG-16	8-14	26.5	29.3	21.5	14	9	29	100 / 2000	500160
PG-19	9-17	29	32	23	17	12	29	100 / 2000	500190
PG-21	10-18	32.3	35.6	28	19	12	35	100 / 1000	500210
PG-25	15-22	32.6	32.6	29.8	24	13	31	100 / 1000	500250
PG-29	16-24	41.1	45.4	36	26	12.5	40	50 / 500	500290
PG-36	18-28	52	58	46	31.5	12.5	45	50 / 350	500360
PG-42	26-36	57.4	61.9	51	37.6	17.5	47	20 / 200	500420
PG-48	32-39	65.2	70.7	58	43	21	50	20 / 200	500480

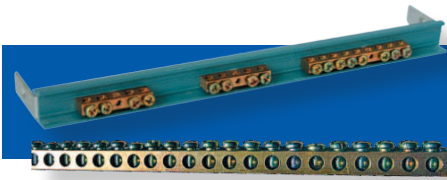

Zero rails

They represent a brass rail with rectangular section with fabric made openings for the conductors and bolts for clamping of the conductor. They are offered in types with insulated and non-insulated rail. They are used in the electrical distribution boxes for zeroing and earthing.

Technical data:

- * Material: brass for the current leading elements
- * Insulation material: plastic
- * Colour: gray/blue
- * Application: general
- * Ambient temperature: -40 to +85°C

Rail type	Length L (mm)	Height H (mm)	Width W (mm)	Ø D (mm)	Bolt	Number of terminals	Packing / Box (pcs)	Catalogue number
BRASS	1000	7.8	6	5	M4	54	100	14002
ZERO insulated	250	-	-	5	M4	16	200	14012

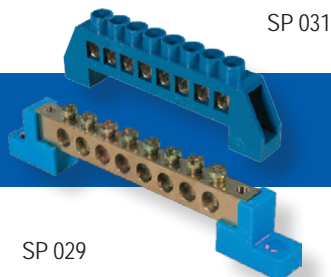

Zero terminals

Rail type	L (mm)	H (mm)	W (mm)	C	Ø D (mm)	M	Packing / Box (pcs)	Catalogue number
SP 029-4	82.9.4	21.5	12	70.5	70.5	5x10	10 / 500	14204
SP 029-6	100.9	21.5	12	88.5	88.5	5x10	10 / 800	14206
SP 029-8	118.9	21.5	12	106.5	106.5	5x10	20 / 300	14208
SP 029-10	136.9	21.5	12	124.5	124.5	5x10	20 / 300	14210
SP 029-12	182.4	21.5	12	170	170	5x10	20 / 250	14212
SP 031-4	59.5	31.5	12.4	48.5	48.5	5x10	5 / 400	14304
SP 031-6	76.5	31.5	12.4	65.5	65.5	5x10	5 / 400	14306
SP 031-8	93	31.5	12.4	82	82	5x10	5 / 400	14308
SP 031-10	111	31.5	12.4	100	100	5x10	5 / 400	14310
SP 031-12	128	31.5	12.4	117	117	5x10	5 / 300	14312

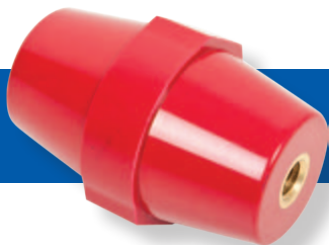

Support insulator for low voltage

Support insulators are used in control and distribution cabinets mounting when bars isolation is required. Provides reliable insulation of live parts.

Technical Specification:

- * Rated voltage: 1000V
- * Insulating voltage: 5000 V
- * Ambient temperature : -40 to +90 C

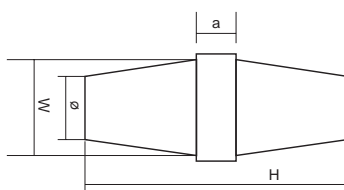

Type	Impulse voltage kV	Strength	Fasting strength	Bolt	Dimmensions (mm)				Packing (pcs.)	Catalogue number
					H	W	a	ø		
SM 25	6	500	6	6	25	30	13	23	10 / 600	31725
SM 30	8	550	8	8	30	32	10	27	10 / 500	31730
SM 35	10	600	10	8	35	32	10	28	10 / 400	31735
SM 40	12	650	12	8	40	40	10	33	10 / 240	31740
SM 51	15	1000	20	8	51	50	12	28	10 / 240	31751
SM 76	25	1500	40	10	76	45	16	34	10 / 120	31776

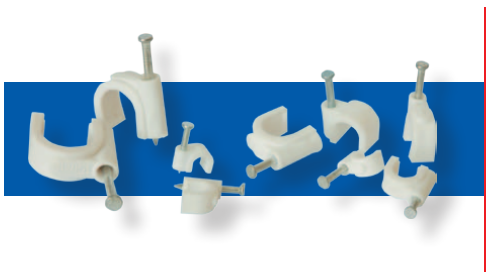

Cable fixing clips

Type	Diameter Ø (mm)	Packing (pcs)	Packing / Box (pcs)	Catalogue number
CHR-4	4	100	500	500004
CHR-5	5	100	500	500005
CHR-6	6	100	300	500006
CHR-7	7	100	300	500007
CHR-8	8	100	250	500008
CHR-9	9	100	200	500009
CHR-10	10	100	200	500010
CHR-12	12	100	100	500012
CHR-14	14	100	50	500014
CHR-16	16	100	50	500016



PVC insulating tape

Colour	Thickness (mm)	Width (mm)	Length (m)	Packing / Box (pcs)	Catalogue number
Black	0.15	19	18,28	10 / 200	51001
Red	0.15	19	18,28	10 / 200	51002
Yellow / Green	0.15	19	18,28	10 / 200	51004
White	0.15	19	18,28	10 / 200	51005
Blue	0.15	19	18,28	10 / 200	51006



Cable tags – sets

Type	Section (mm)	Number in a roller	Packing / Box (pcs)	Catalogue number
EC-0-0	1.5 - 3.2	1000	100	318000
EC-0-1	1.5 - 3.2	1000	100	318001
EC-0-2	1.5 - 3.2	1000	100	318002
EC-0-3	1.5 - 3.2	1000	100	318003
EC-0-4	1.5 - 3.2	1000	100	318004
EC-0-5	1.5 - 3.2	1000	100	318005
EC-0-6	1.5 - 3.2	1000	100	318006
EC-0-7	1.5 - 3.2	1000	100	318007
EC-0-8	1.5 - 3.2	1000	100	318008
EC-0-9	1.5 - 3.2	1000	100	318009

Type	Section (mm)	Number in a roller	Packing / Box (pcs)	Catalogue number
EC-0-a	1.5 - 3.2	1000	100	31800a
EC-0-b	1.5 - 3.2	1000	100	31800b
EC-0-R	1.5 - 3.2	1000	100	31800R
EC-0-S	1.5 - 3.2	1000	100	31800S
EC-0-T	1.5 - 3.2	1000	100	31800T
EC-0-N	1.5 - 3.2	1000	100	31800N
EC-0-P	1.5 - 3.2	1000	100	31800P
EC-0-E	1.5 - 3.2	1000	100	31800E
EC-0-A	1.5 - 3.2	1000	100	31800A
EC-0-B	1.5 - 3.2	1000	100	31800B
EC-0-C	1.5 - 3.2	1000	100	31800C
EC-0-Q	1.5 - 3.2	1000	100	31800Q

Type	Section (mm)	Number in a roller	Packing / Box (pcs)	Catalogue number
EC-1-0	2.6 - 4.2	1000	150	318010
EC-1-1	2.6 - 4.2	1000	150	318011
EC-1-2	2.6 - 4.2	1000	150	318012
EC-1-3	2.6 - 4.2	1000	150	318013
EC-1-4	2.6 - 4.2	1000	150	318014
EC-1-5	2.6 - 4.2	1000	150	318015
EC-1-6	2.6 - 4.2	1000	150	318016
EC-1-7	2.6 - 4.2	1000	150	318017
EC-1-8	2.6 - 4.2	1000	150	318018
EC-1-9	2.6 - 4.2	1000	150	318019

Type	Section (mm)	Number in a roller	Packing / Box (pcs)	Catalogue number
EC-1-a	2.6 - 4.2	1000	150	31801a
EC-1-b	2.6 - 4.2	1000	150	31801b
EC-1-R	2.6 - 4.2	1000	150	31801R
EC-1-S	2.6 - 4.2	1000	150	31801S
EC-1-T	2.6 - 4.2	1000	150	31801T
EC-1-N	2.6 - 4.2	1000	150	31801N
EC-1-P	2.6 - 4.2	1000	150	31801P
EC-1-E	2.6 - 4.2	1000	150	31801E
EC-1-A	2.6 - 4.2	1000	150	31801A
EC-1-B	2.6 - 4.2	1000	150	31801B
EC-1-C	2.6 - 4.2	1000	150	31801C
EC-1-Q	2.6 - 4.2	1000	150	31801Q

Type	Section (mm)	Number in a roller	Packing / Box (pcs)	Catalogue number
EC-2-0	3.6 - 5.2	500	150	318020
EC-2-1	3.6 - 5.2	500	150	318021
EC-2-2	3.6 - 5.2	500	150	318022
EC-2-3	3.6 - 5.2	500	150	318023
EC-2-4	3.6 - 5.2	500	150	318024
EC-2-5	3.6 - 5.2	500	150	318025
EC-2-6	3.6 - 5.2	500	150	318026
EC-2-7	3.6 - 5.2	500	150	318027
EC-2-8	3.6 - 5.2	500	150	318028
EC-2-9	3.6 - 5.2	500	150	318029

Type	Section (mm)	Number in a roller	Packing / Box (pcs)	Catalogue number
EC-2-a	3.6 - 5.2	500	150	31802a
EC-2-b	3.6 - 5.2	500	150	31802b
EC-2-R	3.6 - 5.2	500	150	31802R
EC-2-S	3.6 - 5.2	500	150	31802S
EC-2-T	3.6 - 5.2	500	150	31802T
EC-2-N	3.6 - 5.2	500	150	31802N
EC-2-P	3.6 - 5.2	500	150	31802P
EC-2-E	3.6 - 5.2	500	150	31802E
EC-2-A	3.6 - 5.2	500	150	31802A
EC-2-B	3.6 - 5.2	500	150	31802B
EC-2-C	3.6 - 5.2	500	150	31802C
EC-2-Q	3.6 - 5.2	500	150	31802Q

Type	Section (mm)	Number in a roller	Packing / Box (pcs)	Catalogue number
EC-3-0	5 - 7.2	250	150	318030
EC-3-1	5 - 7.2	250	150	318031
EC-3-2	5 - 7.2	250	150	318032
EC-3-3	5 - 7.2	250	150	318033
EC-3-4	5 - 7.2	250	150	318034
EC-3-5	5 - 7.2	250	150	318035
EC-3-6	5 - 7.2	250	150	318036
EC-3-7	5 - 7.2	250	150	318037
EC-3-8	5 - 7.2	250	150	318038
EC-3-9	5 - 7.2	250	150	318039

Type	Section (mm)	Number in a roller	Packing / Box (pcs)	Catalogue number
EC-3-a	5 - 7.2	250	150	31803a
EC-3-b	5 - 7.2	250	150	31803b
EC-3-R	5 - 7.2	250	150	31803R
EC-3-S	5 - 7.2	250	150	31803S
EC-3-T	5 - 7.2	250	150	31803T
EC-3-N	5 - 7.2	250	150	31803N
EC-3-P	5 - 7.2	250	150	31803P
EC-3-E	5 - 7.2	250	150	31803E
EC-3-A	5 - 7.2	250	150	31803A
EC-3-B	5 - 7.2	250	150	31803B
EC-3-C	5 - 7.2	250	150	31803C
EC-3-Q	5 - 7.2	250	150	31803Q



Heat shrinkage tubes ZDG type

Standard: EN 60 684

Thin-wall heat shrinkage tubes are used for insulation of cable connection, at conductors repair to protect the cable head from corrosion, for protection of the cable insulation from water and moisture, for restoring the cable insulation integrity, etc. It is a plastic thin wall pipe which at temperature higher than 120°C shrinks its initial diameter to a certain degree. The material has high temperature and UV rays wear resistance. The material represents the so called permanently netted plastic. This material is obtained as the plastic billet is processed with the help of high energy electron rays so that inner molecular bonds between adjacent molecules are formed. After that the pipe is heated to the boiling point, the pipe inflates, so do the inner molecular bonds. Then the pipe is sharply refrigerated and the molecules stay in the condition of inflated bonds for indefinite long time. Heating the pipe repeatedly (after being mounted to the given cable) the crystals melt again but due to the net structure, they resume the initial pipe diameter and take the form of the cable, pressing it and not allowing the moisture to get under the pipe.

Technical data:

- * Material: triple cross - linked polyolefin
- * Colours: blue, black, red, yellow, yellow-green, green, white
- * Shrinkage ratio: min 2 : 1
- * Ambient temperature: -40 to + 100°C
- * Shrinkage temperature: min 120°C
- * Condition of the material during fire exposure: slight burning
- * The material does not emit hazardous substances
- * Insulation resistance: $1 \times 10^{12} \Omega/\text{cm}$
- * Application: general
- * Insulating voltage 1000 V



Type	D1 (mm)	D2 (mm)	S (mm)	Packing / Box (m)	Catalogue number *
ZDG	1	0.5	0.04	200 / 4000	301001x
ZDG	1.5	0.75	0.04	200 / 4000	301115x
ZDG	2	1.0	0.05	200 / 4000	301002x
ZDG	3	1.5	0.05	200 / 2000	301003x
ZDG	4	2.0	0.08	100 / 1700	301004x
ZDG	5	2.5	0.08	100 / 1200	301005x
ZDG	6	3.0	0.08	100 / 1000	301006x
ZDG	7	3.5	0.08	100 / 1000	301007x
ZDG	8	4.0	0.08	100 / 1500	301008x
ZDG	9	4.5	0.08	100 / 1500	301009x
ZDG	10	5.0	0.08	100 / 1500	301010x
ZDG	11	5.5	0.08	100 / 1500	301011x
ZDG	12	6.0	0.08	100 / 1200	301012x
ZDG	13	6.5	0.08	100 / 1200	301013x
ZDG	14	7.0	0.08	100 / 1200	301014x
ZDG	15	7.5	0.08	100 / 1200	301015x
ZDG	16	8.0	0.08	100 / 1200	301016x
ZDG	18	9.0	0.08	50 / 600	301018x
ZDG	20	10	0.08	50 / 500	301020x
ZDG	22	11	0.08	50 / 500	301022x
ZDG	25	12.5	0.08	25 / 600	301025x
ZDG	28	14	0.08	25 / 300	301028x
ZDG	30	15	0.08	25 / 300	301030x
ZDG	35	17.5	0.08	25 / 300	301035x
ZDG	40	20	0.08	25 / 250	301040x
ZDG	50	25	0.08	25 / 200	301050x
ZDG	60	30	0.08	25 / 300	301060x
ZDG	70	35	0.08	25 / 250	301070x
ZDG	80	40	0.08	25 / 100	301080x
ZDG	90	45	0.08	25 / 150	301090x
ZDG	100	50	0.08	25 / 100	301100x
ZDG	120	60	0.08	25 / 200	301120x
ZDG	150	75	0.08	25 / 100	301150x

Note: * At orders after the catalogue number of the corresponding diameter a letter showing the colour must be added: B - blue; R - red; K - black; G - green; Y - yellow;

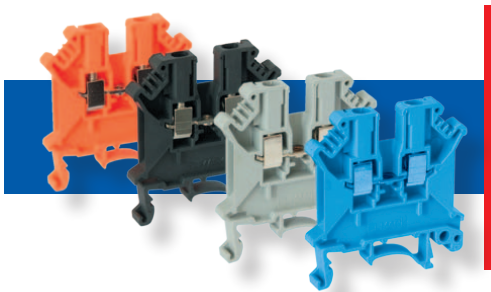

Fixed terminal blocks - LTU2 UK series

Fixed terminal blocks with universal application into electrical distribution boxes. For DIN-rail mounting. Variety of sizes for optimum using of available space by selection of appropriate terminals for the corresponding conductors. Made of non-flammable insulation polymeric material.

Standard: IEC - 60947-7-1

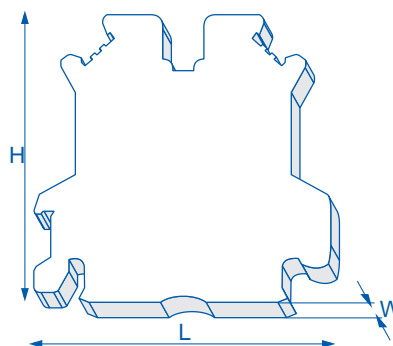

Type	Section of the conductor (mm ²)		Size of the terminal (mm)			In (A)	Un (V)	Colour	Packing / Box (pcs)	Catalogue number
	single-core	multicore	L	H	W					
LTU2UK 3N	0.2-4	0.2-2.5	42.5	47	5.2	32	800	grey	50 / 3000	31033
LTU2UK 3N	0.2-4	0.2-2.5	42.5	47	5.2	32	800	red	50 / 3000	31032
LTU2UK 3N	0.2-4	0.2-2.5	42.5	47	5.2	32	800	black	50 / 3000	31031
LTU2UK 3N	0.2-4	0.2-2.5	42.5	47	5.2	32	800	blue	50 / 3000	31035



Type	Section of the conductor (mm ²)		Size of the terminal (mm)			In (A)	Un (V)	Colour	Packing / Box (pcs)	Catalogue number
	single-core	multicore	L	H	W					
LTU2UK 5N	0.2-6	0.2-4	42.5	47	6.2	41	800	grey	50 / 2000	31053
LTU2UK 5N	0.2-6	0.2-4	42.5	47	6.2	41	800	red	50 / 2000	31052
LTU2UK 5N	0.2-6	0.2-4	42.5	47	6.2	41	800	black	50 / 2000	31051
LTU2UK 5N	0.2-6	0.2-4	42.5	47	6.2	41	800	blue	50 / 2000	31055



Type	Section of the conductor (mm ²)		Size of the terminal (mm)			In (A)	Un (V)	Colour	Packing / Box (pcs)	Catalogue number
	single-core	multicore	L	H	W					
LTU2UK 6N	0.2-10	0.2-6	42.5	47	8.2	57	800	grey	50 / 1000	31063
LTU2UK 6N	0.2-10	0.2-6	42.5	47	8.2	57	800	red	50 / 1000	31062
LTU2UK 6N	0.2-10	0.2-6	42.5	47	8.2	57	800	black	50 / 1000	31061
LTU2UK 6N	0.2-10	0.2-6	42.5	47	8.2	57	800	blue	50 / 1000	31065



Type	Section of the conductor (mm ²)		Size of the terminal (mm)			In (A)	Un (V)	Colour	Packing / Box (pcs)	Catalogue number
	single-core	multicore	L	H	W					
LTU2UK 10N	0.5-16	0.5-10	42.5	47	10.2	76	800	grey	50 / 1000	31103
LTU2UK 10N	0.5-16	0.5-10	42.5	47	10.2	76	800	red	50 / 1000	31102
LTU2UK 10N	0.5-16	0.5-10	42.5	47	10.2	76	800	black	50 / 1000	31101
LTU2UK 10N	0.5-16	0.5-10	42.5	47	10.2	76	800	blue	50 / 1000	31105

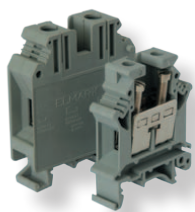

Type	Section of the conductor (mm ²)		Size of the terminal (mm)			In (A)	Un (V)	Colour	Packing / Box (pcs)	Catalogue number
	single-core	multicore	L	H	W					
LTU2UIK 16	2.5-25	4-16	42.5	47	12.2	101	800	grey	50 / 1000	31163
LTU2UIK 35	10-35	10-35	55	62	15.2	125	800	grey	20 / 400	31353



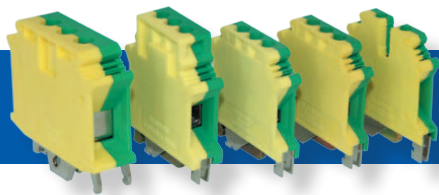

Fixed terminal blocks - JD series

Two-sided insulated fixed terminal blocks designed to connect grounded conductors. Made of non-flammable insulation polymeric material.

Standard: EN 60947-7-1

Type	Section of the conductor (mm ²)		Size of the terminal (mm)			In (A)	Un (V)	Colour	Packing / Box (pcs)	Catalogue number
	single-core	multicore	L	H	W					
5JD	0.2-4	0.2-4	42.5	47	6.2	34	800	yellow-green	50 / 1000	31054
6JD	0.2-10	0.2-6	42.5	47	8.2	37	800	yellow-green	50 / 1000	31064
10JD	0.5-10	0.5-6	42.5	47	8.2	61	800	yellow-green	50 / 1000	31104
16JD	2.5-25	2.5-16	42.5	47	12.2	108	800	yellow-green	50 / 600	31164
35JD	2.5-35	2.5-35	42.5	47	15	135	800	yellow-green	20 / 400	31354

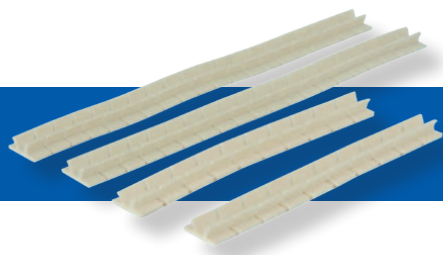

Marking tags - ZB type

Accessories for marking and separation of different electrical circuits, different voltages and fixing of elements for DIN-rail mounting.

Type	Pieces in a strip	Colour	Size (mm)	Packing / Box (pcs)	Catalogue number
ZB6	20	white	6	100 / 1200	31906
ZB8	10	white	8	100 / 1200	31908



End cover

Type	Colour	Thickness (mm)	Packing / Box (pcs)	Catalogue number
EC	grey	8	200 / 6000	31901

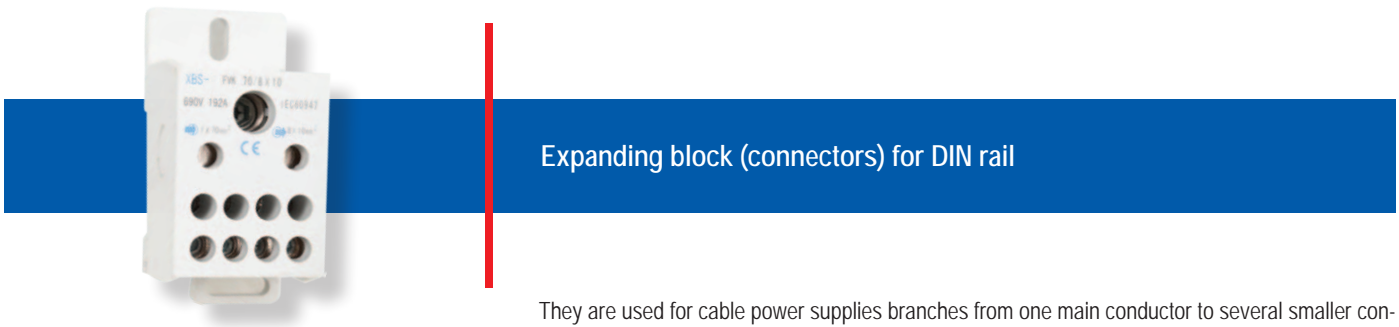

Expanding block (connectors) for DIN rail

They are used for cable power supplies branches from one main conductor to several smaller conductors. Designed for DIN - rail mounting. Presented in different colours according to their usage (blue - null conductor, grey - phase conductor, yellow - green - earthing conductor). Easy to mount, reliable way of connection.

Type	Main Terminal		Secondary Terminal		Colour	Packing / Box (pcs)	Catalogue number
	Current (A)	Section (mm ²)	Number of terminals	Section (mm ²)			
FVK35	125	35	4	10	blue		3193541
FVK35	125	35	4	10	grey		3193542
FVK35	125	35	4	10	yellow-green		3193543
FVK50/4	150	50	4	16	blue		3195041
FVK50/4	150	50	4	16	grey		3195042
FVK50/4	150	50	4	16	yellow-green		3195043
FVK 50/6	150	50	6	10	blue		3195061
FVK 50/6	150	50	6	10	grey		3195062
FVK 50/6	150	50	6	10	yellow-green		3195063
FVK 70/6	192	70	6	2x25+4x10	blue		3197061
FVK 70/6	192	70	6	2x25+4x10	grey		3197062
FVK 70/6	192	70	6	2x25+4x10	yellow-green		3197063
FVK70/8	192	70	8	10	blue		3197081
FVK70/8	192	70	8	10	grey		3197082
FVK70/8	192	70	8	10	yellow-green		3197083

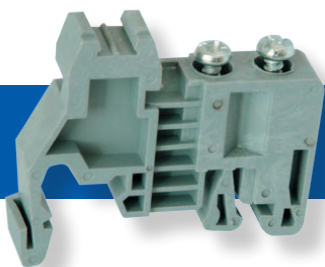

Universal end fixed pieces E/UK type

Type	Colour	Thickness (mm)	Packing / Box (pcs)	Catalogue number
E/UK	grey	5	200 / 2400	31902

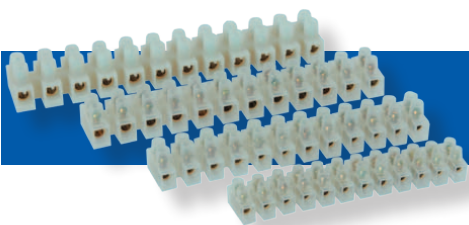

Terminal blocks TBH type

Type	Pieces in a strip	In (A)	Un (V)	Colour	Section of the conductor (mm ²)	Packing / Box (pcs)	Catalogue number
TBH 3A	10	3	660	semitransparent	to 1.5	100 / 1000	31003
TBH 6A	10	6	660	semitransparent	to 4	100 / 1000	31006
TBH 10A	10	10	660	semitransparent	to 6	100 / 500	31010
TBH 15A	10	15	660	white	to 6	100 / 500	31015
TBH 20A	10	20	660	white	to 10	100 / 400	31020



Cable ties - white

Type	Length (mm)	Colour	Width (mm)	Packing (pcs)	Packing / Box (pcs)	Catalogue number
Cable ties	100	white	2.5	100	10 / 800	500100
Cable ties	150	white	2.5	100	10 / 500	500152
Cable ties	160	white	2.5	100	10 / 500	500162
Cable ties	200	white	2.5	100	10 / 400	500202
Cable ties	250	white	3.5	100	10 / 250	500253
Cable ties	280	white	3.5	100	10 / 200	500283
Cable ties	300	white	3.5	100	10 / 200	500303
Cable ties	300	white	4.8	100	10 / 120	500304
Cable ties	370	white	3.5	100	10 / 120	500373
Cable ties	380	white	4.8	100	10 / 100	500384
Cable ties	450	white	4.8	100	10 / 70	500454
Cable ties	500	white	7.9	100	5 / 40	500507



Cable ties - black

Type	Length (mm)	Colour	Width (mm)	Packing (pcs)	Packing / Box (pcs)	Catalogue number
Cable ties	150	black	2.5	100	10 / 500	500151
Cable ties	160	black	2.5	100	10 / 500	500161
Cable ties	250	black	3.5	100	10 / 250	500251
Cable ties	280	black	3.5	100	10 / 200	500281
Cable ties	300	black	3.5	100	10 / 200	500301
Cable ties	500	black	7.9	100	40	500501

TOOLS

TOOLS

EL[®]MARK

S



TOOLS



Digital multimeter EM5510

This is a digital device for measuring of humidity, illumination, temperature and all electric values. It features automatic range adjustment, manual value selection. It has an LCD display showing the measured value in digits with the size of 3 3/4. It is of high accuracy of analogue-digital conversion, precision in measuring and resistance to electro-magnetic interferences. It has an automatic switch off.

Technical features:

- * DC voltage: 0.4 / 4 / 40 / 400 / 600 V
- * AC voltage : 4 / 40 / 400 / 600V
- * DC current: 400μ / 4000μ / 40m / 400m / 10A
- * AC current: 400μ / 4000μ / 40m / 400m / 10A
- * Resistance: 400 / 4K / 40K / 400K / 4M / 40MΩ
- * Capacitors: 4η / 40η / 400η / 4μ / 40μ / 100μF
- * Frequency: 10 / 100 / 1k / 10k / 100k / 200kHz
- * Loading cycles: from 0.1% to 99.9%
- * Temperature: -20° up to 1000°C
- * Humidity: 30% to 95%
- * Illumination: 4000 Lux / 40000 Lux
- * Noise level: 35 to 100dB
- * Circuit control: yes
- * Diodes control: yes
- * Weight: 310 g (including battery)
- * Battery: 1x9V
- * Dimensions: 83 x 162 x 47mm

Type	Packing (pcs) / carton	Catalogue number
EM5510	24	5195510



Digital multimeter EM420C

This is a digital device for measuring of humidity, illumination, temperature and all electric values. It features automatic range adjustment, manual value selection. It has an LCD display showing the measured value in 4 digits with the size of 16 mm. It is of high accuracy of analogue-digital conversion, precision in measuring and resistance to electro-magnetic interferences. It has an automatic switch off.

Technical features:

- * DC voltage: 200m/ 2 / 20 / 200 / 600 V
- * AC voltage : 2 / 20 / 200 / 600V
- * DC current: 200μ / 2000μ / 20m / 200m / 2 / 10A
- * AC current: 00μ / 2000μ / 20m / 200m / 2 / 10A
- * Resistance: 200 / 2K / 20K / 200K / 2M / 20MΩ
- * Temperature: -20° up to 1000°C
- * Battery test: 1.5 / 3 / 9 / 12 V
- * Circuit control: yes
- * Diodes control: yes
- * Weight: 200 g (including battery)
- * battery: 3x1.5 V
- * dimensions: 75 x 158 x 35mm

Type	Packing (pcs) / carton	Catalogue number
EM420C	44	519420



Digital multimeter EM3055

This is a digital device for measuring of all electric values. It features manual range adjustment. It has an LCD display showing the measured value in 4 digits with the size of 3 1/2. It is of high accuracy of analogue-digital conversion, precision in measuring and resistance to electro-magnetic interferences.

Technical features:

- * DC voltage: 200m / 2 / 20 / 200 / 1000 V
- * AC voltage: 2 / 20 / 200 / 750V
- * DC current: 2m / 20m / 200m / 10A
- * AC current: 200m / 10A
- * Resistance: 200 / 2K / 20K / 200K / 2M / 20M / 200MΩ
- * Capacity: 2000p / 20n / 200n / 20μF
- * Temperature: 0° up to 1000°C
- * Battery test: 1.5 / 3 / 9 / 12 V
- * Transistor test: Vce≈3V , Ib≈10μF
- * Circuit control: yes
- * Diodes control: yes
- * Weight: 495 g (including battery)
- * battery: 1x9V
- * dimensions: 97 x 200 x 48mm

Type	Packing (pcs) / carton	Catalogue number
EM3055	20	5193055



Digital multimeter EM3058

This is a digital device for measuring of temperature and all electric values. It features manual range adjustment, manual value selection. It has an LCD display showing the measured value in digits with the size of 3 3/4. It is of high accuracy of analogue-digital conversion, precision in measuring and resistance to electro-magnetic interferences. It has an automatic switch off.

Technical features:

- * DC voltage: 200m / 2 / 20 / 200 / 1000 V
- * AC voltage: 200 m / 2 / 20 / 200 / 750V
- * DC current: 20μ / 200 μ / 2m / 200m / 10A
- * AC current: 20μ / 200μ / 2m / 200m / 2 / 10A
- * Resistance: 200 / 2K / 20K / 200K / 2M / 20M / 200MΩ
- * Capacitors: 2n / 20n / 200n / 2μ / 20μF
- * Frequency: 20kHz to 2000kHz
- * Loading cycles: 0.1% to 99.9%
- * Temperature: 0° up to 1000°C
- * Logical level: High > 2.0 V; Low < 0.8 V
- * Circuit control: yes
- * Diodes control: yes
- * Weight: 495 g (including battery)
- * battery: 1x9V
- * dimensions: 97 x 200 x 47 mm

Type	Packing (pcs) / carton	Catalogue number
EM3058	20	5193058



Digital multimeter EM31

This is a digital device for measuring of electric values. It features automatic range adjustment, manual value selection. It has an LCD display showing the measured value in 4 digits with the size of 16 mm. It is of high accuracy of analogue-digital conversion, precision in measuring and resistance to electro-magnetic interferences. It has an automatic switch off and low battery indication.

Technical features:

- * DC voltage: 240m/ 2400m / 24 / 240 / 600 V
- * AC voltage: 240m/ 2400m / 24 / 240 / 600 V
- * DC current: 240μ / 2400μ / 24m / 240m / 10A
- * AC current: 240μ / 2400μ / 24m / 240m / 10A
- * Resistance: 240 / 2400 / 24K / 240K / 2400K / 24MΩ
- * Capacity: 25η to 252μF
- * Frequency: 50 / 500 / 5000 / 50k / 0.5 MHz
- * Circuit control: yes
- * Diodes control: yes
- * Weight: 137 g (including battery)
- * battery: 2x1.5 V
- * dimensions: 70 x 126 x 28mm

Type	Packing (pcs) / carton	Catalogue number
EM31	56	519031



Digital multimeter / pen EM3215

This is a digital device for measuring of electric values in the form of a pen. It features automatic range adjustment, manual value selection. It has an LCD display, data retain function, automatic reset, polarity selection, range overload indication. It is of high accuracy of analogue-digital conversion, precision in measuring and resistance to electro-magnetic interferences. It has an automatic switch off and low battery indication and a torch.

Technical features:

- * DC voltage: 200m/ 2 / 20 / 200 / 600 V
- * AC voltage: 2 / 20 / 200 / 600V
- * DC current: 20m to 200mA
- * AC current: 20m to 200mA
- * Resistance: 200 / 2K / 20K / 200K / 2M / 20MΩ
- * Logical level: High > 2.3V; Low < 0.8 V
- * Circuit control: yes
- * Diodes control: yes
- * Weight: 182 g (including battery)
- * battery: 1x9V
- * dimensions: 57 x 230 x 30mm

Type	Packing (pcs) / carton	Catalogue number
EM3215	42	5193215



Digital clamp meter EM202

This is a digital clamp meter for measuring of electric values. It features manual range adjustment, manual value selection. It has an LCD display showing the measured value in digits with the size of 3½ mm. It is of high accuracy of analogue-digital conversion, precision in measuring and resistance to electro-magnetic interferences. It has an automatic switch off.

- Technical features:
- * DC voltage: 1000 V
 - * AC voltage: 750V
 - * AC current: 20 / 200 / 1000A
 - * Resistance: 200 kΩ
 - * Temperature: -40° up to 1400°C
 - * Circuit control: yes
 - * Diodes control: yes
 - * Weight: 400 g (including battery)
 - * battery: 1x9V
 - * dimensions: 99 x 250 x 43mm

Type	Packing (pcs) / carton	Catalogue number
EM202	18	519202



Digital clamp meter EM204

This is a digital clamp meter for measuring of electric values. It features automatic range adjustment, manual value selection. It has an LCD display, low battery indication, overload protection. It is of high accuracy of analogue-digital conversion, precision in measuring and resistance to electro-magnetic interferences. It has an automatic switch off.

- Technical features:
- * DC voltage: 1000 V
 - * AC voltage: 750V
 - * DC current: 200 / 1000A
 - * AC current: 200 / 1000A
 - * Resistance: 200 kΩ
 - * Frequency: 2 kHz
 - * Circuit control: yes
 - * Weight: 400 g (including battery)
 - * battery: 1x9V
 - * dimensions: 99 x 258 x 43mm

Type	Packing (pcs) / carton	Catalogue number
EM204	18	519204



Digital clamp meter EM266

This is a digital clamp meter for measuring of electric values. It features manual range adjustment. It has an LCD display and retain function option, low battery indication and overload protection.

Technical features:

- * DC voltage: 1000 V
- * AC voltage: 750V
- * AC current: 200 / 1000A
- * Resistance: 200 / 20 k Ω
- * Circuit control: yes
- * Diodes control: yes
- * Weight: 310 g (including battery)
- * battery: 1x9V
- * dimensions: 69 x 229 x 38mm

Type	Packing (pcs) / carton	Catalogue number
EM266	20	519266



Infrared temperature meter EM520A

This is a digital device for measuring of temperature. The temperature is measured with no contact. It has a laser counter for precision measuring, suitable large LCD display, battery low indication and overload protection.

Technical features:

- * Temperature: -20° up to 320°C / -4° to 608 °F
- * Distance to point size: 6:1
- * Precision: $\pm 2^\circ$ C or 2% in reading
- * battery: 1x9V
- * dimensions: 90 x 155 x 45mm

Type	Packing (pcs) / carton	Catalogue number
EM520A	20	519520



Phase meter Gk7

A device indicating phase availability in the system. No contact phase indicator featuring sound and light indication of phase availability.

- Technical features:
- * Voltage range: from 50 to 1000V
 - * Frequency range: from 50 Hz to 500 Hz
 - * dimensions: length – 62mm

Type	Packing (pcs) / carton	Catalogue number
GK7	60	519GK7



Digital detector 4 in 1 series TS530

This is a device for detecting metals, voltage and live conductors, wooden struts, or piping sections. The device has a 2-meter measuring tape. It features light and sound indication. When an object is located, the display light blinks and marks with increasing position. Once the exact position is located, a light point is marked on the wall through a button.

- Technical features:
- * 2-meter measuring tape
 - * Pen: marking the located detail
 - * Piping section: metal pipe up to 25mm
 - * Wooden struts: 30x30mm
 - * Live conductors detection: 50mm for 90 ~ 250V; 50/60Hz
 - * Weight: 213 g (including battery)
 - * battery: 1x9 V
 - * dimensions: 73 x 180 x 32mm

Type	Packing (pcs) / carton	Catalogue number
TS530	30	519530



Industrial repair kit ETK06A

A finely packaged repair kit containing four elements in a metal briefcase, sealed with special plastic foam and struts for each instrument.

- The kit includes:
- * Digital multimeter EM420
 - * Digital clamp-on ammeter EM465
 - * Phase meter GK7
 - * Infrared temperature meter EM520A

Type	Packing (pcs) / carton	Catalogue number
ETK06A	6	51906A



Hydraulic crimping pliers HT - 300 type

Functions:

* Crimping of aluminum or copper conductors with cable terminals or bush in the corresponding size

Technical data:

* Crimping head turning at 360° which facilitates the crimping of static conductors

* Device for automatic following of the effort at crimping completion

* Form of the crimping element: hexahedral

* Size of the crimping element: 16, 25, 35, 50, 70, 95, 120, 150, 185, 240, 300 mm²

* Section of the crimping conductors:

- Al conductors - from 16 to 300 mm²

- Cu conductors – from 16 to 240 mm²

* Element pressing power: 60kN

* Width of the element: 17mm

* Weight of the instrument: 3.3 kg

* Length: 460mm

* Used hydraulic oil: Shell Tellus T15

* Metal box for the instrument

* A set of congestion hoops for the hydraulic cylinder

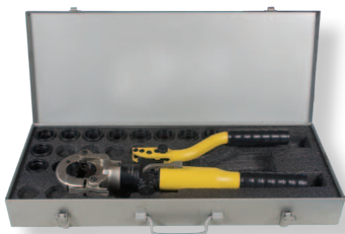

Type	Packing (pcs) box / carton	Catalogue number
HT - 300	2	59300



Hydraulic crimping pliers KYQ-300B type

Functions:

* Crimping of aluminum or copper conductors with cable terminals or bush in the corresponding size

Technical data:

* Device for automatic following of the effort at crimping completion

* Form of the crimping element: hexahedral

* Size of the crimping element: 16, 25, 35, 50, 70, 95, 120, 150, 185, 240, 300 mm²

* Section of the crimping conductors:

- Al conductors - from 16 to 300 mm²

- Cu conductors – from 16 to 240 mm²

* Element pressing power: 16T

* Width of the element: 22mm

* Weight of the instrument: 6.8 kg

* Length: 500mm

* Used hydraulic oil: #23 (hydraulic oil with viscosity 23)

* Metal box for the instrument

* A set of congestion hoops for the hydraulic cylinder



Type	Packing (pcs) box / carton	Catalogue number
KYQ-300B	2	59302



Hydraulic crimping pliers YQK-300 type

Functions:

* Crimping of aluminum or copper conductors with cable terminals or bush in the corresponding size

Technical data:

- * Form of the crimping element: hexahedral
- * Size of the crimping element: 16, 25, 35, 50, 70, 95, 120, 150, 185, 240, 300 mm²
- * Section of the crimping conductors:
 - Al conductors - from 16 to 300 mm²
 - Cu conductors – from 16 to 240 mm²
- * Element pressing power: 16T
- * Width of the element: 22mm
- * Weight of the instrument: 6.3 kg
- * Length: 500mm
- * Used hydraulic oil: Shell Tellus T15
- * Metal box for the instrument
- * A set of congestion hoops for the hydraulic cylinder



Type	Packing (pcs) box / carton	Catalogue number
YQK-300	4	59301



Hydraulic crimping pliers YQK – 50 type

Functions:

* Crimping of aluminum or copper conductors with cable terminals or bush in the corresponding size

Technical data:

- * Form of the crimping element: hexahedral
- * Size of the crimping element: 4, 6, 10, 16, 25, 35, 50 mm²
- * Section of the crimping conductors:
 - Al conductors - from 4 to 50mm²
 - Cu conductors – from 4 to 50 mm²
- * Element pressing power: 8T
- * Width of the element: 10mm
- * Weight of the instrument: 2.8 kg
- * Length: 310mm
- * Used hydraulic oil: Shell Tellus T15
- * Metal box for the instrument
- * A set of congestion hoops for the hydraulic cylinder



Type	Packing (pcs) box / carton	Catalogue number
YQK – 50	5	59303



Hydraulic punching pliers WK - 8 type

Functions:

- * Cutting through openings in sheet metal with gauge up to 3mm without rotary motion

Technical data:

- * Piercing head turning at 360°
- * Form of the cutting element: round
- * Size of the cutting element: Ø 22, 27.5, 34.3, 40, 49, 60.8mm
- * Piercing capacity:
 - sheet metal 3mm – openings up to Ø 30mm
 - sheet metal 2mm – openings up to Ø 60mm
- * Element pressing power: 80kN
- * Thickness of the element: 25mm
- * Weight of the instrument: 3.5 kg
- * Used hydraulic oil: #15 (hydraulic oil with viscosity 15)
- * Metal box for the instrument
- * A set of congestion hoops for the hydraulic cylinder
- * Additional set of cutting elements for cable glands – Ø16, 20, 26.2, 32.5, 39, 51, 63 and a square for display devices 46.5x46.5, 68x68 (ordered additionally); Catalogue number 54002

Type	Packing (pcs) box / carton	Catalogue number
WK - 8	2	54000
Additional set	2	54002



Hydraulic punching press SYK – 15 type

Functions:

- * Cutting through openings in sheet metal with gauge up to 3mm without rotary motion

Technical data:

- * Protracting piercing head supplied with a hose for the hydraulic oil that gives possibility for piercing openings everywhere on the metal surface
- * Form of the cutting element:
 - round
 - square
- * Size of the cutting element:
 - square: 32x32mm
 - round openings: Ø 22, 27.5, 34.3, 40, 49, 60.8mm
- * Piercing capacity:
 - sheet metal 3mm – openings up to Ø 60.8mm
 - sheet metal 2mm – openings up to Ø 115.5mm
 - square opening up to 110x110mm
- * Element pressing power: 15T
- * Thickness of the element: 25mm
- * Weight of the instrument: 11.5 kg
- * Used hydraulic oil: #15 (hydraulic oil with viscosity 15)
- * Metal box for the instrument
- * A set of congestion hoops for the hydraulic cylinder
- * Additional set of cutting elements for cable glands – Ø16, 20, 26.2, 32.5, 39, 51, 63 and a square for display devices 46.5x46.5, 68x68 (ordered additionally); Catalogue number 54002

Type	Packing (pcs) box / carton	Catalogue number
SYK – 15	2	54001
Additional set	2	54002



Combined scissors HS – 2103 type

Functions:

- * Cleaning of the plastic insulation of conductors and conductors
- * Cutting of aluminum or copper cable conductors up to 6mm²
- * Cutting of bearing steel plated wires up to 2mm²
- * Crimping of cable terminals

Technical data:

- * Possibility for crimping of automobile high voltage conductors
- * Possibility for crimping of cable conductors up to 6mm²
- * Maximum section of the cable: up to 6mm²
- * Weight of the instrument: 0.21kg
- * Length of the instrument: 213mm
- * Packing: blister

Type	Packing (pcs) box / carton	Catalogue number
HS – 2103	50	59310

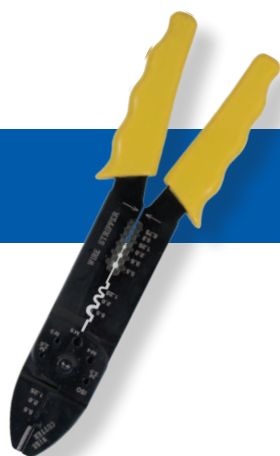

Combined scissors HS – 2603 type

Functions:

- * Cleaning of the plastic insulation of conductors and conductors
- * Cutting of aluminum or copper cable conductors up to 6mm²
- * Cutting of bearing steel plated wires up to 2mm²
- * Crimping of cable terminals

Technical data:

- * Possibility for crimping of cable conductors up to 6mm²
- * Maximum section of the cable:
 - cleaning of a rigid conductor: from 0.5 to 6mm²
 - cleaning of a flexible conductor: from 0.75 to 6mm²
- * Presence of openings for cutting of bolts: from M2.5 to M5
- * Weight of the instrument: 0.32kg
- * Length of the instrument: 240mm
- * Packing: blister

Type	Packing (pcs) box / carton	Catalogue number
HS – 2603	50	59311



Instrument for manual crimping of conductors HD – 005 type

Functions:

- * Crimping of naked cable terminals

Technical data:

- * Possibility for crimping of cable conductors up to 10mm²
- * Form of the crimping head: hexahedral
- * Weight of the instrument: 0.49kg
- * Length of the instrument: 220mm
- * Packing: blister

Type	Packing (pcs) box / carton	Catalogue number
HD – 005	20	59308



Instrument for manual crimping of conductors G – 301H type

Functions:

- * Crimping of isolated cable terminals

Technical data:

- * Possibility for crimping of cable conductors up to 6mm²
- * Form of the crimping head: hexahedral
- * Weight of the instrument: 0.49kg
- * Length of the instrument: 220mm
- * Packing: blister

Type	Packing (pcs) box / carton	Catalogue number
G – 301H	20	59307



Crimping pliers SN – 003 type

Functions:

- * Crimping of naked cable terminals and joining bushes

Technical data:

- * Possibility for crimping of cable conductors from 6 to 16mm²
- * Form of the crimping head: hexahedral
- * Weight of the instrument: 0.39kg
- * Length of the instrument: 190mm
- * Packing: blister

Type	Packing (pcs) box / carton	Catalogue number
SN – 003	10 / 20	59309



Crimping pliers HY –200R type

Functions:

- * Used for cleaning and crimping of 4, 6, and 8 core telephone or grid conductors
- * Crimping of terminals/couplings for telephone or computer grids

Technical data:

- * Possibility for crimping of cable conductors for 4, 6 or 8 cores
- * Weight of the instrument: 0.55kg
- * Length of the instrument: 200mm
- * Packing: blister

Type	Packing (pcs) box / carton	Catalogue number
HY –200R	50	59312



Mechanical cable cutting pliers CC – 325 type

Functions:

- * Cutting of aluminum or copper cable conductors
- * Cutting of conductors with metal bearing core

Technical data:

- * Maximum section of the cable:
 - for aluminum conductors up to 150mm²
 - for copper conductors up to 150mm²
- * Cutting power: 15T
- * Presence of cutting mechanism type ratchet
- * Presence of brake of the cutting mechanism
- * Weight of the instrument: 0.58kg
- * Length of the instrument: 260mm
- * Packing: blister

Type	Packing (pcs) box / carton	Catalogue number
CC – 325	5 / 10	59305



Mechanical cable cutting pliers CC – 400 type

Functions:

- * Cutting of aluminum or copper cable conductors
- * Cutting of conductors with metal bearing core

Technical data:

- * Maximum section of the cable:
 - for aluminum conductors up to 400mm²
 - for copper conductors up to 350mm²
- * Cutting power: 15T
- * Presence of cutting mechanism type ratchet
- * Presence of brake of the cutting mechanism
- * Weight of the instrument: 1.25kg
- * Length of the instrument: 360mm
- * Packing: blister

Type	Packing (pcs) box / carton	Catalogue number
CC – 400	5	59304



Mechanical cable cutting pliers HS – 250 type

Functions:

- * Cutting of aluminum or copper cable conductors
- * Cutting of conductors with metal bearing core

Technical data:

- * Maximum section of the cable:
 - for aluminum conductors up to 240mm²
 - for copper conductors up to 185mm²
- * Weight of the instrument: 1.43kg
- * Length of the instrument: 540mm
- * Packing: blister

Type	Packing (pcs) box / carton	Catalogue number
HS – 250	10	59306



- Manufactured to exact standards.
- Chrome Vanadium Steel
- Induction hardened cutting edges.
- Bi-material TPR soft-grip handle.
- Ergonomic design for comfortable, firm grip. GS/TUV approved.



Combination Pliers



Type	Size (mm)	Packing (pcs) hanging card / box / carton	Catalogue number
Combination pliers	160	1 / 6 / 36	592100160
Combination pliers	180	1 / 6 / 36	592100180
Combination pliers	200	1 / 6 / 36	592100200



Type	Size (mm)	Packing (pcs) hanging card / box / carton	Catalogue number
Side cutting pliers	160	1 / 6 / 36	592200160
Side cutting pliers	180	1 / 6 / 36	592200180



Side Cutting Pliers



Long Nose Pliers



Type	Size (mm)	Packing (pcs) hanging card / box / carton	Catalogue number
Long nose pliers	160	1 / 6 / 36	592300160
Long nose pliers	200	1 / 6 / 36	592300200

Bent Nose Pliers



Type	Size (mm)	Packing (pcs) hanging card / box / carton	Catalogue number
Bent nose pliers	160	1 / 6 / 36	592400160
Bent nose pliers	200	1 / 6 / 36	592400200

Flat Nose Pliers



Type	Size (mm)	Packing (pcs) hanging card / box / carton	Catalogue number
Flat nose pliers	160	1 / 6 / 36	592500160

- Manufactured to exact standards.
- Chrome Vanadium Steel
- Induction hardened cutting edges.
- Bi-material TPR soft-grip handle.
- Ergonomic design for comfortable, firm grip.
- GS/TUV approved.



Wire Stripping Pliers



Type	Size (mm)	Packing (pcs) hanging card / box / carton	Catalogue number
Wire Stripping pliers	160	1 / 6 / 36	592600160

Side Cutting Pliers, Heavy Duty



Type	Size (mm)	Packing (pcs) hanging card / box / carton	Catalogue number
Side cutting pliers	180	1 / 6 / 36	592201180

- Manufactured to exact standards.
- Chrome Vanadium Steel
- Induction hardened cutting edges.
- Bi-material TPR soft-grip handle.
- Ergonomic design for comfortable, firm grip.
- GS/TUV approved.

Bent Nose Mini Pliers



Type	Size (mm)	Packing (pcs) hanging card / box / carton	Catalogue number
Bent nose mini pliers	115	1 / 12 / 120	592400115



Combination Mini Pliers



Type	Size (mm)	Packing (pcs) hanging card / box / carton	Catalogue number
Combination mini pliers	115	1 / 12 / 120	592100115



Side Cutting Mini Pliers



Type	Size (mm)	Packing (pcs) hanging card / box / carton	Catalogue number
Side cutting mini pliers	115	1 / 12 / 120	592200115



End Cutting Mini Pliers



Type	Size (mm)	Packing (pcs) hanging card / box / carton	Catalogue number
End cutting mini pliers	115	1 / 12 / 120	592700115



- Manufactured to exact standards.
 - Chrome Vanadium Steel
 - Induction hardened cutting edges.
 - Bi-material TPR soft-grip handle.
 - Ergonomic design for comfortable, firm grip.
- GS/TUV approved.



VDE Combination Pliers

Type	Size (mm)	Packing (pcs) hanging card / box / carton	Catalogue number
VDE Combination Pliers	180	1 / 6 / 60	599100180

VDE Long Nose Pliers



Type	Size (mm)	Packing (pcs) hanging card / box / carton	Catalogue number
VDE Long Nose Pliers	180	1 / 6 / 60	599300180



Type	Size (mm)	Packing (pcs) hanging card / box / carton	Catalogue number
VDE Side Cutting Pliers	160	1 / 6 / 60	599200160

VDE Side Cutting Pliers



Type	Size (mm)	Packing (pcs) hanging card / box / carton	Catalogue number
VDE Cable Cutting Pliers	160	1 / 6 / 60	599600180

VDE Cable Cutting Pliers

- Designed for great performance with thumb pressure points.
- Extra torque and comfort.
- Chrome vanadium steel.
- Magnetic tip.
- Ergonomic comfort-grip handle.

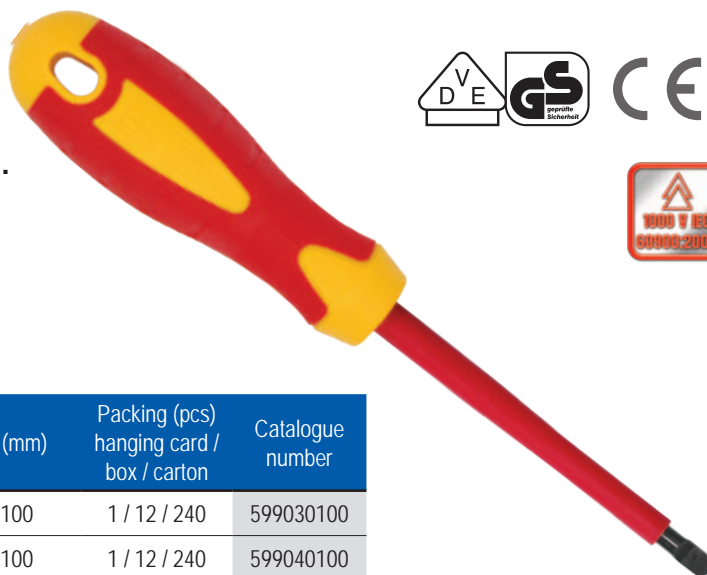

Type	Size (mm)	L (mm)	Packing (pcs) hanging card / box / carton	Catalogue number
VDE Screwdriver, Slotted	3	100	1 / 12 / 240	599030100
VDE Screwdriver, Slotted	4	100	1 / 12 / 240	599040100



Type	Size (mm)	L (mm)	Packing (pcs) hanging card / box / carton	Catalogue number
VDE Screwdriver	PH1	80	1 / 12 / 240	599001080
VDE Screwdriver	PH2	100	1 / 12 / 120	599020100

- Designed for great performance with thumb pressure points.
- Extra torque and comfort.
- Chrome vanadium steel.
- Magnetic tip.
- Ergonomic comfort-grip handle.



Type	Size	L (mm)	Packing (pcs) hanging card / box / carton	Catalogue number
Mini Screwdriver	6	38	1 / 12 / 120	593160038
Screwdriver	3	100	1 / 12 / 120	593130100
Screwdriver	4	100	1 / 12 / 120	593140100
Screwdriver	4	150	1 / 12 / 120	593140150
Screwdriver	5	100	1 / 12 / 120	593150100
Screwdriver	5	150	1 / 12 / 120	593150150
Screwdriver	6	100	1 / 12 / 120	593160100
Screwdriver	6	150	1 / 12 / 120	593160150
Screwdriver	8	150	1 / 6 / 60	593180150



Type	Size	L (mm)	Packing (pcs) hanging card / box / carton	Catalogue number
Mini Screwdriver	PH2	38	1 / 12 / 120	593202038
Screwdriver	PH0	75	1 / 12 / 120	593200075
Screwdriver	PH0	100	1 / 12 / 120	593200100
Screwdriver	PH0	150	1 / 12 / 120	593200150
Screwdriver	PH1	75	1 / 12 / 120	593201075
Screwdriver	PH1	100	1 / 12 / 120	593201100
Screwdriver	PH1	150	1 / 12 / 120	593201150
Screwdriver	PH2	100	1 / 12 / 120	593202100
Screwdriver	PH2	150	1 / 12 / 120	593202150
Screwdriver	PH3	150	1 / 6 / 60	593203150



Type	Size	L (mm)	Packing (pcs) hanging card / box / carton	Catalogue number
Screwdriver	PZ0	75	1 / 12 / 120	593300075
Screwdriver	PZ1	100	1 / 12 / 120	593301100
Screwdriver	PZ2	150	1 / 12 / 120	593302150
Screwdriver	PZ3	150	1 / 6 / 60	593303150



Type	Size	L (mm)	Packing (pcs) hanging card / box / carton	Catalogue number
Screwdriver	T5	75	1 / 12 / 120	593400005
Screwdriver	T6	75	1 / 12 / 120	593400006
Screwdriver	T7	75	1 / 12 / 120	593400007
Screwdriver	T8	75	1 / 12 / 120	593400008
Screwdriver	T9	75	1 / 12 / 120	593400009
Screwdriver	T10	100	1 / 12 / 120	593400010
Screwdriver	T15	100	1 / 12 / 120	593400015
Screwdriver	T20	100	1 / 12 / 120	593400020
Screwdriver	T25	100	1 / 12 / 120	593400025
Screwdriver	T27	100	1 / 12 / 120	593400027
Screwdriver	T30	100	1 / 12 / 120	593400030
Screwdriver	T40	150	1 / 6 / 60	593400040





Bit driver

Type	Size	L (mm)	Packing (pcs) hanging card / box / carton	Catalogue number
Bit driver	1/4	90	1 / 12 / 120	594500090



Magnetic bit holder

Type	Size	L (mm)	Packing (pcs) hanging card / box / carton	Catalogue number
Magnetic bit holder	1/4	60	1 / 125 / 500	594500060





Slotted bit - 25 mm



Type	Size	L (mm)	Packing hanging card (pcs)	Packing (pcs) box / carton	Catalogue number
Slotted bit	4,0	25	2	125 / 500	594104025
Slotted bit	4,5	25	2	125 / 500	594104525
Slotted bit	5,5	25	2	125 / 500	594105525
Slotted bit	6,0	25	2	125 / 500	594106025
Slotted bit	6,5	25	2	125 / 500	594106525
Slotted bit	8,0	25	2	125 / 500	594108025
Slotted bit	9,0	25	2	125 / 500	594109025



Slotted bit - 50 mm



Type	Size	L (mm)	Packing hanging card (pcs)	Packing (pcs) box / carton	Catalogue number
Slotted bit	4,0	50	2	125 / 500	594114050
Slotted bit	4,5	50	2	125 / 500	594114550
Slotted bit	5,5	50	2	125 / 500	594115550
Slotted bit	6,0	50	2	125 / 500	594116050
Slotted bit	6,5	50	2	125 / 500	594116550
Slotted bit	8,0	50	2	125 / 500	594118050
Slotted bit	9,0	50	2	125 / 500	594119050





PH bit - 25 mm



Type	Size	L (mm)	Packing hanging card (pcs)	Packing (pcs) box / carton	Catalogue number
PH bit	PH0	25	2	125 / 500	594200025
PH bit	PH1	25	2	125 / 500	594200125
PH bit	PH2	25	2	125 / 500	594200225
PH bit	PH3	25	2	125 / 500	594200325



PH bit - 50 mm



Type	Size	L (mm)	Packing hanging card (pcs)	Packing (pcs) box / carton	Catalogue number
PH bit	PH1	50	2	125 / 500	594210150
PH bit	PH2	50	2	125 / 500	594210250
PH bit	PH3	50	2	125 / 500	594210350
PH bit	PH4	50	2	125 / 500	594210450



PZ bit - 25 mm



Type	Size	L (mm)	Packing hanging card (pcs)	Packing (pcs) box / carton	Catalogue number
PZ bit	PZ0	25	2	125 / 500	594300025
PZ bit	PZ1	25	2	125 / 500	594300125
PZ bit	PZ2	25	2	125 / 500	594300225
PZ bit	PZ3	25	2	125 / 500	594300325



PZ bit - 50 mm



Type	Size	L (mm)	Packing hanging card (pcs)	Packing (pcs) box / carton	Catalogue number
PZ bit	PZ1	50	2	125 / 500	594310150
PZ bit	PZ2	50	2	125 / 500	594310250
PZ bit	PZ3	50	2	125 / 500	594310350
PZ bit	PZ4	50	2	125 / 500	594310450





TORX bit - 25 mm



Type	Size	L (mm)	Packing hanging card (pcs)	Packing (pcs) box / carton	Catalogue number
TORX bit	T4	25	2	125 / 500	594400425
TORX bit	T5	25	2	125 / 500	594400525
TORX bit	T6	25	2	125 / 500	594400625
TORX bit	T7	25	2	125 / 500	594400725
TORX bit	T8	25	2	125 / 500	594400825
TORX bit	T9	25	2	125 / 500	594400925
TORX bit	T10	25	2	125 / 500	594401025
TORX bit	T15	25	2	125 / 500	594401525
TORX bit	T20	25	2	125 / 500	594402025
TORX bit	T25	25	2	125 / 500	594402525
TORX bit	T27	25	2	125 / 500	594402725
TORX bit	T30	25	2	125 / 500	594403025
TORX bit	T40	25	2	125 / 500	594404025



TORX bit - 50 mm



Type	Size	L (mm)	Packing hanging card (pcs)	Packing (pcs) box / carton	Catalogue number
TORX bit	T10	50	2	125 / 500	594411050
TORX bit	T15	50	2	125 / 500	594411550
TORX bit	T20	50	2	125 / 500	594412050
TORX bit	T25	50	2	125 / 500	594412550
TORX bit	T27	50	2	125 / 500	594412750
TORX bit	T30	50	2	125 / 500	594413050
TORX bit	T40	50	2	125 / 500	594414050



- High quality forged Chrome Vanadium Steel,
- Ergonomic design comfort-grip handle.
- Quick-release button.
- Flip reverse
- 72 teeth fine mechanism.



Type	Size	Packing (pcs) hanging card / box / carton	Catalogue number
Ratchet handle	1/4"	1 / 50 / 100	595100014
Ratchet handle	3/8"	1 / 25 / 50	595100038
Ratchet handle	1/2"	1 / 14 / 28	595100012

- Industrial Socket Set with quick-release and flip reverse ratchet handle.
- Ergonomic design comfort-grip handle.
- Innovative storage hanger.



11pc Socket Set 1/4"

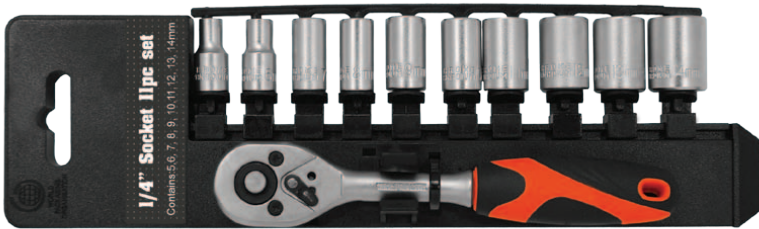

Contents:
5mm,6mm, 7mm, 8mm, 9mm,
10mm,11mm,12mm, 13mm, 14mm

Type	Size	Packing (pcs) hanging card / box / carton	Catalogue number
Socket Set - 11 pcs	1/4"	1 / 6 / 24	595200014

11pc Socket Set 1/2"

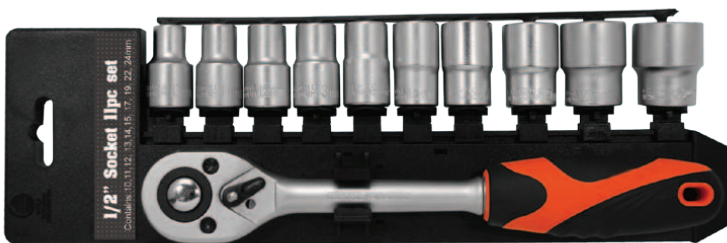

Contents:
10mm,11mm, 12mm, 13mm, 14mm,
15mm,17mm, 19mm, 22mm,24mm

Type	Size	Packing (pcs) hanging card / box / carton	Catalogue number
Socket Set - 11 pcs	1/2"	1 / 6 / 12	595200012

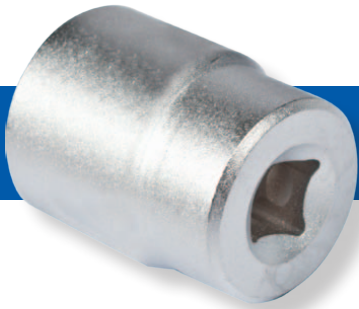

Hexagon socket 1/4"



Type	Size	Packing (pcs) hanging card / box / carton	Catalogue number
1/4" socket	4mm	1 / 14 / 280	595300040
1/4" socket	4.5mm	1 / 14 / 280	595300045
1/4" socket	5mm	1 / 14 / 280	595300050
1/4" socket	5.5mm	1 / 14 / 280	595300055
1/4" socket	6mm	1 / 14 / 280	595300060
1/4" socket	7mm	1 / 14 / 280	595300070
1/4" socket	8mm	1 / 14 / 280	595300080
1/4" socket	9mm	1 / 14 / 280	595300090
1/4" socket	10mm	1 / 14 / 280	595300100
1/4" socket	11mm	1 / 14 / 280	595300110
1/4" socket	12mm	1 / 14 / 280	595300120
1/4" socket	13mm	1 / 14 / 280	595300130
1/4" socket	14mm	1 / 14 / 280	595300140

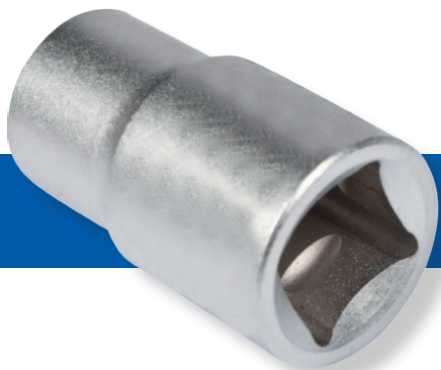

Hexagon socket 3/8"



Type	Size	Packing (pcs) hanging card / box / carton	Catalogue number
3/8" socket	6mm	1 / 14 / 280	595400006
3/8" socket	7mm	1 / 14 / 280	595400007
3/8" socket	8mm	1 / 14 / 280	595400008
3/8" socket	9mm	1 / 14 / 280	595400009
3/8" socket	10mm	1 / 14 / 280	595400010
3/8" socket	11mm	1 / 14 / 280	595400011
3/8" socket	12mm	1 / 14 / 280	595400012
3/8" socket	13mm	1 / 12 / 240	595400013
3/8" socket	14mm	1 / 12 / 240	595400014
3/8" socket	15mm	1 / 12 / 240	595400015
3/8" socket	16mm	1 / 12 / 240	595400016
3/8" socket	17mm	1 / 12 / 240	595400017
3/8" socket	18mm	1 / 10 / 200	595400018
3/8" socket	19mm	1 / 10 / 200	595400019
3/8" socket	20mm	1 / 10 / 200	595400020
3/8" socket	21mm	1 / 8 / 160	595400021



Hexagon socket 1/2"



Type	Size	Packing (pcs) hanging card / box / carton	Catalogue number
1/2" socket	10mm	1 / 10 / 200	595500010
1/2" socket	11mm	1 / 10 / 200	595500011
1/2" socket	12mm	1 / 10 / 200	595500012
1/2" socket	13mm	1 / 10 / 200	595500013
1/2" socket	14mm	1 / 10 / 200	595500014
1/2" socket	15mm	1 / 10 / 200	595500015
1/2" socket	16mm	1 / 10 / 200	595500016
1/2" socket	17mm	1 / 8 / 160	595500017
1/2" socket	18mm	1 / 8 / 160	595500018
1/2" socket	19mm	1 / 8 / 160	595500019
1/2" socket	20mm	1 / 8 / 160	595500020
1/2" socket	21mm	1 / 8 / 160	595500021
1/2" socket	22mm	1 / 8 / 160	595500022
1/2" socket	23mm	1 / 6 / 120	595500023
1/2" socket	24mm	1 / 6 / 120	595500024
1/2" socket	27mm	1 / 5 / 100	595500027
1/2" socket	30mm	1 / 4 / 80	595500030
1/2" socket	32mm	1 / 4 / 80	595500032

- Drop Forged with hardened jaws,
- Ergonomic design comfort-grip handle.
- Smooth Runing Jaw Adjustment.



Type	Size (mm)	Packing (pcs) hanging card / box / carton	Catalogue number
Adjustable wrench	150	1 / 6 / 120	596100150
Adjustable wrench	200	1 / 6 / 60	596100200
Adjustable wrench	300	1 / 6 / 60	596100300





- High quality forged Chrome Vanadium Steel, 15° offset as per DIN standard.
- Satin Chrome plated against corrosion.

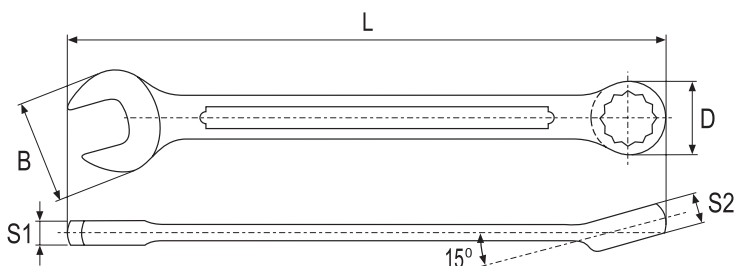

Type	⌀ (mm)	L (mm)	B (mm)	D (mm)	S1 (mm)	S2 (mm)	Packing (pcs) hanging card / box / carton	Catalogue number
Combination Spanner	6	110	15,2	10,8	3,7	5,0	1 / 12 / 300	596200006
Combination Spanner	7	120	17,0	12,0	3,8	5,5	1 / 12 / 300	596200007
Combination Spanner	8	130	18,8	13,2	4,2	6,0	1 / 12 / 300	596200008
Combination Spanner	9	140	20,8	14,6	4,4	6,5	1 / 12 / 300	596200009
Combination Spanner	10	150	22,8	16,0	4,7	7,0	1 / 12 / 300	596200010
Combination Spanner	11	160	24,8	17,3	5,0	7,5	1 / 12 / 300	596200011
Combination Spanner	12	170	26,8	18,6	5,3	8,0	1 / 12 / 300	596200012
Combination Spanner	13	180	28,8	20,0	5,6	8,5	1 / 12 / 240	596200013
Combination Spanner	14	190	30,8	21,4	5,9	9,0	1 / 12 / 240	596200014
Combination Spanner	15	200	32,8	22,8	6,2	9,5	1 / 12 / 180	596200015
Combination Spanner	16	210	34,8	24,2	6,5	10,0	1 / 12 / 180	596200016
Combination Spanner	17	220	36,8	25,6	6,8	10,5	1 / 12 / 120	596200017
Combination Spanner	18	230	38,8	27,0	7,1	11,0	1 / 12 / 120	596200018
Combination Spanner	19	240	40,8	28,4	7,4	11,5	1 / 6 / 120	596200019
Combination Spanner	20	250	42,8	29,8	7,6	12,0	1 / 6 / 120	596200020
Combination Spanner	21	260	44,8	31,2	7,8	12,3	1 / 6 / 90	596200021
Combination Spanner	22	270	46,8	32,6	8,0	12,5	1 / 6 / 90	596200022
Combination Spanner	23	280	48,8	34,4	8,2	12,8	1 / 6 / 90	596200023
Combination Spanner	24	290	50,8	35,4	8,5	13,0	1 / 6 / 60	596200024
Combination Spanner	27	320	56,8	39,6	9,4	14,5	1 / 6 / 60	596200027

- High quality forged Chrome Vanadium Steel.
- Satin Chrome plated against corrosion.

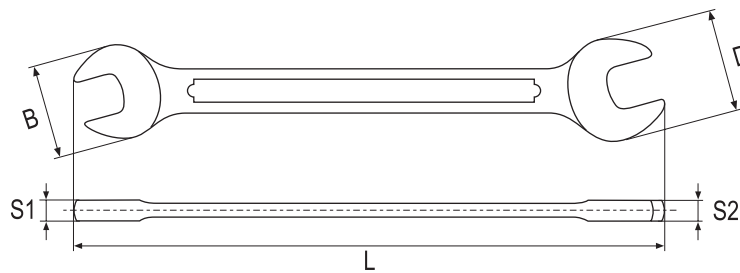

Type	⌀ (mm)	L (mm)	B (mm)	D (mm)	S1 (mm)	S2 (mm)	Packing (pcs) hanging card / box / carton	Catalogue number
Double Open Spanner	6x7	120	17,5	15,4	3,5	3,6	1 / 12 / 300	596300067
Double Open Spanner	8x9	140	22,0	19,5	3,9	3,6	1 / 12 / 300	596300089
Double Open Spanner	10x11	155	26,0	23,5	4,5	4,6	1 / 12 / 300	596301011
Double Open Spanner	12x13	170	30,0	27,6	5,0	5,3	1 / 12 / 300	596301213
Double Open Spanner	14x15	185	34,0	32,0	5,5	5,4	1 / 12 / 240	596301415
Double Open Spanner	16x17	200	38,0	35,3	6,0	6,3	1 / 12 / 180	596301617
Double Open Spanner	18x19	220	42,2	39,5	6,5	6,3	1 / 12 / 180	596301819
Double Open Spanner	20x22	235	48,0	43,5	7,0	6,8	1 / 6 / 120	596302022
Double Open Spanner	21x23	245	50,0	45,8	7,5	6,9	1 / 6 / 60	596302123
Double Open Spanner	25x28	270	59,5	54,0	8,4	8,3	1 / 6 / 48	596302528
Double Open Spanner	30x32	295	67,7	64,0	9,0	8,6	1 / 6 / 48	596303032



- High quality forged Chrome Vanadium Steel, with 75° offset ring end.
- Satin Chrome plated against corrosion.

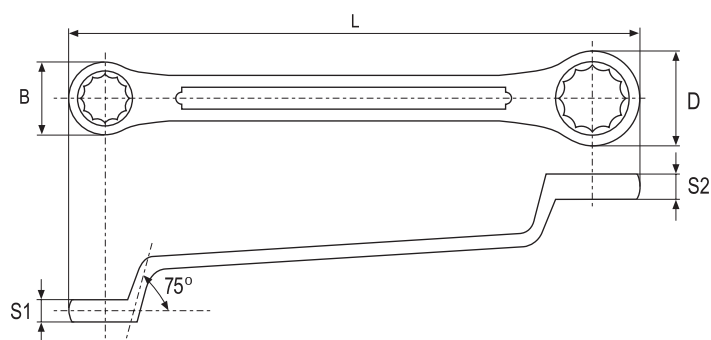

Type	⚙️ (mm)	L (mm)	B (mm)	D (mm)	S1 (mm)	S2 (mm)	Packing (pcs) hanging card / box / carton	Catalogue number
Double Offset Ring Spanner	6x7	165	12,4	10,9	5,5	5,0	1 / 12 / 240	596400067
Double Offset Ring Spanner	8x9	180	15,4	13,9	6,5	6,0	1 / 12 / 240	596400089
Double Offset Ring Spanner	10x11	195	18,0	16,6	7,5	7,0	1 / 12 / 240	596401011
Double Offset Ring Spanner	12x13	215	21,0	19,6	8,5	8,0	1 / 12 / 240	596401213
Double Offset Ring Spanner	14x15	235	23,6	22,2	9,5	9,0	1 / 6 / 150	596401415
Double Offset Ring Spanner	16x17	250	26,3	25,0	10,5	10,0	1 / 6 / 150	596401617
Double Offset Ring Spanner	18x19	265	29,0	27,6	11,5	11,0	1 / 6 / 120	596401819
Double Offset Ring Spanner	20x22	285	33,2	30,4	13,0	12,0	1 / 6 / 90	596402022
Double Offset Ring Spanner	21x23	305	34,6	31,8	13,5	12,5	1 / 6 / 60	596402123
Double Offset Ring Spanner	24x27	325	40,5	36,0	15,0	14,0	1 / 6 / 60	596402427
Double Offset Ring Spanner	25x28	340	42,0	37,5	15,5	14,5	1 / 6 / 30	596402528
Double Offset Ring Spanner	30x32	375	47,0	44,0	16,5	16,0	1 / 6 / 30	596403032



9 pcs Hex Key Set

- Chrome vanadium steel, hardened and tempered.
- Folding plastic tray with LED light.
- Satin chrome plated finish.

Contents:

1.5, 2, 2.5, 3,
4, 5, 6, 8, 10mm



Type	Packing (pcs) hanging card / box / carton	Catalogue number
Hex Key Set	1 / 10 / 20	596501510



9 pcs Torx Key Set With Hole

- Chrome vanadium steel, hardened and tempered.
- Folding plastic tray with LED light.
- Satin chrome plated finish.

Contents:

T10, T15, T20,
T25, T27, T30,
T40, T45, T50



Type	Packing (pcs) hanging card / box / carton	Catalogue number
Torx Key Set with Hole	1 / 10 / 20	596501050



12 in 1 Ratchet Screwdriver and Bits Set

- Ratchet screwdriver with 12 pc bits.
- Ergonomic handle.
- Window display box for easy storage and selection.

Contents:

1 pc 1/4" ratchet screwdrive handle

12 pcs CRV 1/4" Bits:

3 pcs slotted: 4.0x25mm, 5.5x25mm, 6.0x25mm

3 pcs philips: PH1x25mm, PH2x25mm, PH3x25mm

3 pcs pozi: PZ1x25mm, PZ2x25mm, PZ3x25mm

3 pcs torx: T15, T20, T25



Type	Packing (pcs) box / carton	Catalogue number
12 in 1 Ratchet Screwdriver and Bits Sets	1 / 6 / 24	594600012



- Cuts on the push and the pull for fine cutting.
- Hard point fine teeth triple ground.
- Ergonomic comfort-grip handle.

Type	Size (mm)	Packing (pcs) box / carton	Catalogue number
Saw	400	1 / 6 / 60	597200400



Type	Size (mm)	Packing (pcs) box / carton	Catalogue number
Hacksaw frame	300	1 / 6 / 36	597200300

Hacksaw Frame

- Light duty with rigid square tubular frame and die-cast handle.



- Reinforced Fibre glass shaft, Impact-Absorbent Soft Grip.
- Drop-Forged alloy steel head.
- Polished striking face.
- Ergonomic comfort-grip TPR handle.

Machinist Hammer

Type	Size (g)	Packing (pcs) box / carton	Catalogue number
Mechinist Hammer	300	1 / 6 / 24	597100300
Mechinist Hammer	400	1 / 6 / 24	597100400

Rubber Mallet



- Desinged to protect the workpiece where a metal hammer may cause damage.
- Reinforced Fibre glass shaft.
- Ergonomic comfort-grip TPR handle.

Type	Size (g)	Packing (pcs) box / carton	Catalogue number
Rubber Mallet	450	1 / 6 / 36	597100450





Auto retracting safety snap off knife

- Features auto retracting blade which prevents inadvertent exposure of cutting edge and subsequent injury/damage.



Type	Size (mm)	Packing (pcs) hanging card / box / carton	Catalogue number
Auto retracting safety snap off knife	9	1 / 12 / 288	597300009
Spare blades	9	10 / 40 / 600	597310009

Snap off knife

- Pull the button and cartridge backward to refill new blades.
- Push the button completely forward to release used blade.
- Soft-grip handle.



Type	Size (mm)	Packing (pcs) hanging card / box / carton	Catalogue number
Snap off knife (+ 5pcs blades)	18	1 / 12 / 96	597300018
Spare blades	18	10 / 20 / 300	597310018



- Smart designed Bi-material casing, 3-rivet hook and spring return mechanism.
- Auto-lock blade.
- Strong, durable blade with magnet.



Type	Size	Packing (pcs) hanging card / box / carton	Catalogue number
Tape Measure	3 m x 16 mm	1 / 12 / 120	597400316
Tape Measure	5 m x 19 mm	1 / 12 / 120	597400519

- Robust aluminium box section with milled surfaces, comfort-grip for ease of handling, rubberised end caps. 3 accurate vials.
- Accurate to 0.5mm/m.



Type	Size	Packing (pcs) box / carton	Catalogue number
Level	800 mm	1 / 24	597500080
Level	1200 mm	1 / 12	597500120

Product displays



Product displays



Product displays

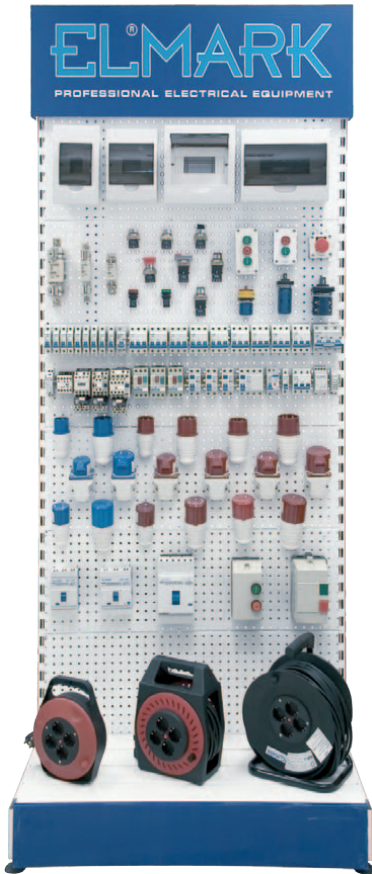

Showrooms



ELMARK HOLDING's participation in technical exhibitions



Paris, France

“Livin Luce” Milano, Italy



Hannover Messe, Germany





OFFICES:	VARNA - CENTRAL OFFICE
BULGARIA	SOFIA PLOVDIV DOBRICH
ROMANIA	BUCHAREST CLUJ-NAPOCA ORADEA
SERBIA	KRAGUIJEVAC BEOGRAD
CROATIA	ZAGREB SPLIT
GREECE	THESSALONIKI
HUNGARY	BUDAPEST

DISTRIBUTORS:	
BOSNA AND HERZEGOVINA	ZENICA
MONTEBEGRO	NIKSIC PODGORICA
FYR OF MACEDONIA	SKOPJE
POLAND	KALWARIA ZEBRZYDOWSKA
PORTUGAL	GUIMARAES
SLOVENIA	LJUBLJANA
LITHUANIA	VILNIUS
JORDAN	AMMAN

ELMARK FACTORY IN EUROPE

ELMARK INDUSTRIES SC
BULGARIA, DOBRICH
2 Dobrudja Blvd.
Tel: +359 58 500 059; +359 58 500 050
Fax: +359 58 500 060
E-mail: elmarkfactory@elmarkholding.eu

GENERAL REPRESENTATIVE FOR BULGARIA

ElektroMarkeT LTD GRUP

BULGARIA, VARNA
ZPZ, 10 Perla Str.
Tel.: +359 52 57 55 57
Fax: +359 52 57 55 80
E-mail: officevarna@elmarkgroup.eu

BULGARIA, SOFIA
18 Nedelcho Bonchev Str.
Tel./Fax: +359 2 971 15 60 / 61
E-mail: officesofia@elmarkgroup.eu

BULGARIA, PLOVDIV
159 Vasil Aprilov Blvd.
Tel./Fax: +359 32 968 210
E-mail: officeplovdiv@elmarkgroup.eu

BULGARIA, VELIKO TARNOVO
EU route E772 to Sofia, near City petrol station,
Tel.: +359 61 242 080
Fax: +359 61 242 090

GENERAL REPRESENTATIVE FOR ROMANIA

ElektroMarkeT SRL IMPORT-EXPORT

ROMANIA, BUCURESTI
58 Bucuresti Urziceni Str.
Tel.: +40 21 351 54 81 / 82
Fax: +40 21 351 54 83
E-mail: officebucharest@elmarkgroup.eu

ROMANIA, CLUJ - NAPOCA
10 Orastie Str., Dept. 13
PARC LOGISTIC TRANSILVANIA
Tel./Fax: +40 264 256 545
E-mail: officecluj@elmarkgroup.eu

ROMANIA, ORADEA
24A Ignatie Daraban NR A Str.
Tel./Fax: +40 25 941 81 51
E-mail: officeoradea@elmarkgroup.eu

GENERAL REPRESENTATIVE FOR SERBIA

ElektroMarkeT DOO GRUP

SERBIA, KRAGUJEVAC
Industrijska bb Str.
Tel.: +381 34 311 777
Fax: +381 34 311 778
E-mail: officekragujevac@elmarkgroup.eu

SERBIA, BELGRADE
Zemun - Altina, 5A Mala Pruga Str.
Mobile: +381 63 114 77 82
Tel./Fax: +381 11 316 39 50
E-mail: officebelgrade@elmarkgroup.eu

GENERAL REPRESENTATIVE FOR CROATIA

ElektroMarkeT DOO GRUPA

CROATIA, Zagreb-Lučko, 20 Ventilatorska Str.
Tel.: +385 1 6530 427
Fax: +385 1 6531 085
E-mail: officezagreb@elmarkgroup.eu

CROATIA, SPLIT
Solina - Split, Zoranićeva 61
Tel.: +385 21 689 975
Fax: +385 21 689 976
E-mail: officesplit@elektromarket.eu

GENERAL REPRESENTATIVE FOR BOSNA I HERCEGOVINA

STANEX DOO
Zenica, 17 KRALJA TVRKA I Str.
Tel.: +387 32 444 040

GENERAL REPRESENTATIVE FOR GREECE

ElektroMarkeT M.EPE GRUP

GREECE, THESSALONIKI
Thessaloniki - Pylaia
Capital Trade Center
22 Laertou Str.
Tel: +30 2310 474 221
Fax: +30 2310 474 228
E-mail: officethessaloniki@elektromarket.eu

GENERAL REPRESENTATIVE FOR HUNGARY

ElektroMarkeT KFT GRUP

HUNGARY, BUDAPEST
1117, 183 Budafoki Str.
Tel: +36 1 371 0374
Tel./Fax: +36 1 371 0373
E-mail: officebudapest@elektromarket.eu

GENERAL REPRESENTATIVE FOR SLOVENIA

TEMS-US D.O.O.
SLOVENIA, LJUBLJANA
Cesta na vrhovce 12
Tel.: +386 1 256 51 00
E-mail: primo@tems-us.si

GENERAL REPRESENTATIVE FOR MONTENEGRO

TRGOTEHNA DOO
MONTENEGRO, NIKSHICH
10 Zarka Zrenjanina Str.
Tel.: +382 40 246 056, Mobile: +382 67 447 448
E-mail: trgotehna@t-com.me

OKOV DOO
MONTENEGRO, PODGORICA
26 Josipa Broza Str.
Tel.: +382 20 658 501, Fax: +382 20 658 502
E-mail: okov@okov.me

GENERAL REPRESENTATIVE FOR FYR OF MACEDONIA

PIT KOM DOO
MACEDONIA, NEGOTINO
120 Dame Gruev Str.
Tel.: +389 43 370 287
Fax: +389 43 370 282
E-mail: pitcom@mt.net.mk

GENERAL REPRESENTATIVE FOR POLAND

AM-ELEKTRO
POLAND, KALWARIA ZEBRZYDOWSKA
3 TARGOWA Str.
Tel.: +48 33 870 44 45
Fax: +48 33 870 44 46
Mobile +48 512 290 352
E-mail: biuro@am-elektro.pl

GENERAL REPRESENTATIVE FOR JORDAN

SOFIA IMPORT&EXPORT EST.
JORDAN, AMMAN
SHAFI BARDAN - ASP UNIVERSITY CIRCLE
PRINCE TATAL BIN MOHAMMAD STR.
Tel.: +962 7 77 749649
Fax: +962 6 53 38589
E-mail: waleed_qudah@yahoo.com

GENERAL REPRESENTATIVE FOR PORTUGAL

A.LOPES & FERNANDES LDA.
PORTUGAL, GUIMARAES
Ruda de Pereira, Fermentoes
Tel.: +351 253 557 000
Fax: +351 253 556 898
E-mail: aloves@aloves.biz

GENERAL REPRESENTATIVE FOR LITHUANIA

LITECHNIKA SC
LITHUANIA, VILNIUS
51 Paneriu Str.
Tel.: +370 698 33 695
E-mail: info@litechnika.lt